



The SPECTRUM

“Achieve the wisdom of knowledge of Truth
as this will enable you to wisely follow the Laws of The Creation.”

— A Non-Profit Educational Corporation Dedicated To Bringing You The Truth —

VOLUME 5, NUMBER 1

NEWS REVIEW

US\$5.00 / CAN\$7.00

JULY 2003

Cancer Cure Since 1930s We're Being *Robbed* By FDA, AMA, Big Business

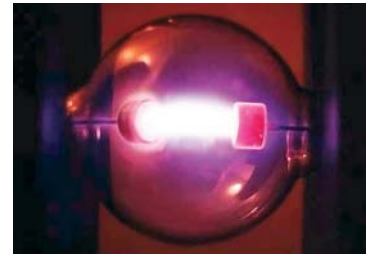

6/4/03 RICK MARTIN

“There are third-world countries more infection-free than our [U.S.] hospitals, which have infection rates, leading to death, of over 100,000 citizens per year. This rate does not match the number of deaths caused annually by medical abuse, mis-diagnoses, and mis-application of drugs which, together with hospital infections, cause 270,000 deaths per year.” — Jim Folsom (FDA victim)

The United States of America is in a health crisis of staggering proportions. What happened to the supposedly most bountiful and advanced nation on Earth?

Millions and millions of Americans have no healthcare coverage, and can't afford the costs of the medical-pharmaceutical cartel's stable of remedies. Meanwhile, many who CAN afford “the system” are disillusioned by fixes creating more problems than the patient began with.

Therefore, millions and millions of Americas have been seeking so-called “alternative” approaches to health and wellness. And with statistics like Jim Folsom mentioned above, who can blame anyone for wanting a saner approach to health and wellness?

(See: **Cancer Cure Since 1930s**, p.30)

IN THIS ISSUE:

Happy Birthday, Nikola Tesla pg.3

The News Desk:
Items You Won't Want To Miss pg.4

SOLTEC: Your Lively, Living Universe:
Both Without And Within pg.27

Who Was Dr. Wilhelm Reich? And Why Has
History Tried So Hard To Erase Him? pg.73

ROBERT RYAN: Cancer Research:
A *Super Fraud*? pg.78

HILARION: Understanding Your
Bio-Electric Sensing Machine pg.81

JOHN THOMAS: Blindness, Mad Cow Disease,
And “Canola” Oil pg.86

AL MARTIN: Bushonomics And The
Downfall Of America pg.94

For more information
please visit our website:
www.TheSpectrumNews.org
or call us at:
1-877-280-2866



NEWEST OFFERINGS AT WISDOM BOOKS

Painful Questions: An Analysis of the September 11th Attack

by Eric Hufschmid



\$20.00 (+S/H)
Code: PQB (1.5 lb.)

Is the U.S. Government so incompetent that the 9/11 attack merely appears to be a scam? This book discusses the aspects of the September 11th attack and the response of the U.S. Government that can make us wonder whether our government is involved in the attack, or whether they are so amazingly incompetent that they only appear to be involved. A government of idiots is as dangerous as a government of conspirators, so we have a serious problem in either case. The suggestion that the CIA or military knew about the 9/11 attack is often rebuffed with a remark similar to: "But it doesn't make sense for them to allow the attack!" It may not make sense to you, but it may have made sense to them. After all, it made sense for them to use Americans in LSD and nuclear radiation experiments many years ago. For all we know, they decided to sacrifice a few thousand of our lives and a few

billion of our dollars to help us gain access to Caspian Sea oil. Perhaps some British government officials also allowed the attack for that Caspian oil, and perhaps some Israelis wanted the attack so they could justify attacking their neighbors.

Those of you who do not believe anything illegal occurred should look for explanations for the mysteries this book brings up. The inability to properly explain the attack is simply more evidence that we are witnessing an incredible scam.

Painful Deceptions



A video supplement to the book *Painful Questions: An Analysis of the September 11th Attack*.

The World Trade Center Towers: How could both towers disintegrate into dust and short sections of steel in 10 seconds?

Building 7: How could this 47-story, steel-framed building disintegrate at 5:30 that evening?

The Attack at the Pentagon: How could a terrorist fly a Boeing 757 into the restricted airspace around the Pentagon?

Created by Eric Hufschmid.

DVD video – 2 hrs.
\$15.00 (+S/H)
Code: PDD (0.5 lb.)

VHS video – 2 hrs.
\$15.00 (+S/H)
Code: PDV (1.0 lb.)

SEE NEXT-TO-LAST PAGE FOR ORDERING OR CALL TOLL-FREE: 1-877-280-2866

THE WAR ON FREEDOM: THE 9/11 CONSPIRACIES

BY JIM MARRS

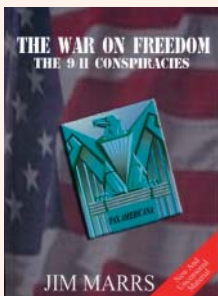

\$19.95 (+S/H)
Code: WOF (1.75 lb.)

Was the U.S. invasions of Afghanistan and Iraq planned long before the tragedies of September 11, 2001? Why did many WTC survivors mention bombs? Why did normal security measures consistently fail that day? Why has no one in government been fired or even reprimanded for failure to anticipate and prevent the attacks? For that matter, who was truly behind the strikes? Who and where is Osama bin Laden? What connects the bin Laden and Bush families?

If the purpose of the perpetrators of 9/11 was to end traditional American freedoms, they may well have succeeded. Laws rushed through a Congress that never had a chance to read them while under a declared state of emergency have curtailed our freedoms.

Research for *The War On Freedom* was begun on September 11, 2001 and culminated in a contract with a major New York publisher. Despite passing a legal review and the excited interest of the editors, the book was suddenly canceled with the explanation that it may "upset the families of 9/11 victims". These families, as well as the public, deserve the truth, even if it is not "politically correct". Here are the uncensored facts; judge for yourself.

Jim Marrs is an award-winning Texas journalist whose books *Crossfire* and *Rule By Secrecy* reached the *New York Times* Best Seller List. He teaches at the University of Texas at Arlington and is a frequent talk-show guest. He lives in Wise County, Texas.

SEE NEXT-TO-LAST PAGE FOR ORDERING OR CALL TOLL-FREE: 1-877-280-2866

MARK HAZLEWOOD WITH GUEST JAMES M. MCCANNEY AT THE 2002 GLOBAL WINGS CONFERENCE

(available on VHS & DVD)



This 2.5-hour presentation is a recording of the lecture given in Denver, Colorado, where hundreds of people gathered to learn more about the reasons for our weather variations, directly related to the drastically escalating solar flare activity. Learn about the connection between our Sun and the changes now taking place all over the world, and understand why we can expect much greater effects to take place, as our tenth planet approaches. Prof. James McCanney explains, in easily understandable terms, the true nature of our solar system and tells you why this information is suppressed.

VHS video – 2.5 hrs.
\$22.00 (+S/H)
Code: PXV (1.0 lb.)

DVD video – 2.5 hrs.
\$22.00 (+S/H)
Code: PXD (0.5 lb.)

SEE NEXT-TO-LAST PAGE FOR ORDERING OR CALL TOLL-FREE: 1-877-280-2866

Behold A Pale Horse

audio cassettes, read by the author William Cooper

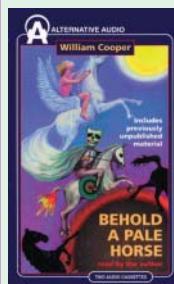

"William Cooper is the only man in America who has all the pieces to the puzzle that has troubled so many for so long." (Anthony Hilder, Radio Free America)

William Cooper, a former U.S. Naval Intelligence Briefing Team member, accurately predicted the fall of the Soviet Union, the end of the Berlin Wall, and the invasion of Panama. His information came from top-secret documents that he read while with the Intelligence Briefing Team and from over twenty years of research. Cooper reveals his theories on the assassination of John F. Kennedy, the war on drugs, and UFOs. He urges the listener: "Like it or not, everything is changing. The result will be the most wonderful experience in human history or the most horrible enslavement you can imagine. Be active or abdicate; the future is in your hands."

2 Audio Cassettes – 3 hrs.
\$17.95 (+S/H)
Code: BPHA (1.0 lb.)

SEE NEXT-TO-LAST PAGE FOR ORDERING OR CALL TOLL-FREE: 1-877-280-2866

HAPPY BIRTHDAY, NIKOLA TESLA

After 23 years, it still angers me to talk about this subject. But the shorter—and less painful—version of the story fits well with accounts in this month's *SPECTRUM* on what happened to Dr. Royal Raymond Rife and Dr. Wilhelm Reich.

My story began on Father's Day of 1976. Based on earlier research into Kirlian Photography, I built a detector (see photo) which I thought might show the presence of "psychic" energies like those flowing from the hands of a healer. It was about the size of a sandwich, and operated sort of like a Geiger Counter. In the wee hours, just after the clock struck Father's Day of 1976, it was finally ready to test. So I fired it up for the first time. And it worked.

Boy, did it work! I soon found that you could even concentrate on it, mentally, from another room, and cause it to chatter away like you've seen Geiger Counters do near radiation in the old science fiction movies.

Over the next several years I performed some 2000 novel, painstaking experiments to prove that what was happening was genuine. Some involved then-well-known psychics who were friends and wanted to visit my lab at Stanford to play with "that contraption of yours" after the word got around.

My goal was "simply" to prove, once and for all, that such non-physical energies existed, so science could move past the point of arguing over whether or not they're real, and get on with expanding such an amazing frontier of understanding.

In 1980 the milestone scientific paper describing my detector and its astonishing attributes was sent to the foremost scientific journal in the world for disseminating new fundamental phenomena. Mind you, any paper carrying the kinds of implications this one did certainly needed to be supported by strong evidence of repeatable, quality experiments—as I said, more than 2,000 in this case. That's what helps other scientists who read the paper to discern if something real is going

on. The stage was set for a fundamental, undeniable revolution in the scientific acceptance of matters psychic. Or so I thought.

Of course, I was naïve back then about how science REALLY worked. I hadn't yet hit my first brick wall. But I was about to.

It wasn't long before the top scientific journal's response came back to me in a letter from the esteemed Editor. I'll never forget the one key sentence that made me grow up fast: **"Clearly what you are describing is not possible, therefore you must have done something wrong."**

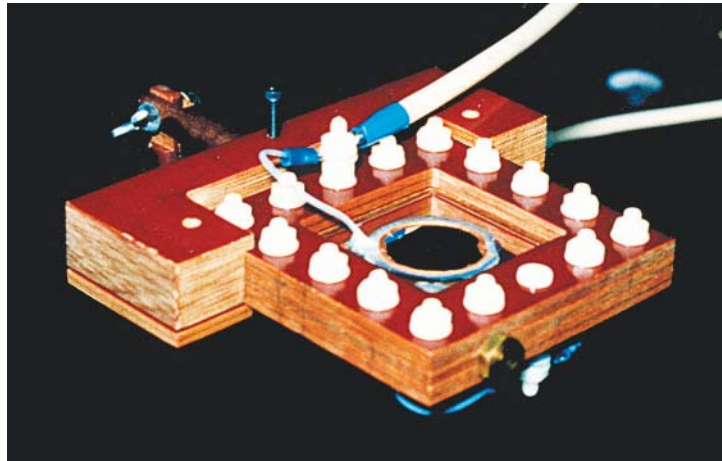

What was that again?!? The overwhelming evidence I reported was not up for debate. My findings should have been shared widely so other careful scientists could conduct their own experiments and observe the same fantastic phenomena I uncovered.

Ah—but now we're glimpsing the REAL agenda! There was no way such paradigm-busting findings were going to be allowed into print to awaken a wide audience of credible scientists. Especially not when so comprehensive a disinformation campaign was in full swing from the highest levels of the world controllers to keep conventional science ignorant of the whole world of subtle energies and their awesome implications for mankind.

Many other brick walls followed, and soon, just to survive, I had to completely shelve the many years of grueling yet amazing research and, with lingering outrage, turn to

"acceptable" scientific pursuits.

Every year around now, I'm reminded of this eye-opening chapter in my life—not only because that's when it all began, but also because it's the birthday time of the most notable "unseen guide" haunting me during that research, Nikola Tesla.

He was born at midnight between July 9 and 10, 1856, in a tiny house in the village of Smiljan, province of Lika, Croatia, between Yugoslavia's Velebit Mountains and the eastern shore of the Adriatic Sea.

Like Rife and Reich after him, Tesla's most important work was only really understood by those who knew

how completely it threatened to topple their control mechanisms long enslaving humanity. Were his most profound gifts to all of us not so craftily stolen and hidden away, our planetary society would have been well on its way from prison to paradise a century ago!

Tesla opens his great little 1919 book titled *My Inventions* with this deep, clue-filled reflection:

"The progressive development of man is vitally dependent on invention. It is the most important product of his creative brain. Its ultimate purpose is the complete mastery of mind over the material world, the harnessing of the Forces of Nature to human needs. This is the difficult task of the inventor, who is often misunderstood and unrewarded. But he finds ample compensation in the pleasing exercises of his powers and in the knowledge of being one of that exceptionally privileged class without whom the race would have long ago perished in the bitter struggle against pitiless elements."

As we read herein about what happened to Rife and Reich (and by inference, many others) when they tried to share the fruits of their creativity for the upliftment of the human condition—as Tesla attempted before them—may we make a solemn vow to stop such freedom-robbing atrocities from persisting any longer.

Happy Birthday, Nikola Tesla!
— Dr. Edwin M. Young, Editor-In-Chief

We cover a “full spectrum” of news and information to help you follow the First Law of The Creation. The Highest (First) Command of The Creation states: “Achieve the wisdom of knowledge of Truth, as this will enable you to wisely follow the Laws of The Creation.”

The SPECTRUM can be regarded as class notes for a graduate-level course in The Truth that no university would dare teach.

TO SUBSCRIBE

For orders call toll-free: 1-877-280-2866

Otherwise call: 1-661-823-9696

6 issues = \$25 U.S. / \$30 Canada / \$35 Foreign

12 issues = \$45 U.S. / \$55 Canada / \$60 Foreign

(Note: All prices are in U.S. dollars)

Please call for bulk subscription rates.

EDITORIAL POLICY

Opinions of *The SPECTRUM* contributors and advertisers are their own and do not necessarily reflect those of *The SPECTRUM* staff or management. *The SPECTRUM* will always correct any meaningful error of fact.

Permission is hereby granted to anyone to quote *The SPECTRUM* in whole or in part, so long as FULL credit of this source is given, including contacting address, phone number, and Internet website.

PUBLISHING INFORMATION

We intend to offer, to the best of our ability, The Truth, however it comes to us, in order to allow you to make your own informed decisions about matters that impact your daily life. We hope to broaden your choices and empower you to create a better world.

The SPECTRUM assumes no responsibility for unsolicited manuscripts.

The SPECTRUM is published the second Tuesday of each month by The Spectrum Newspaper, Inc., 9101 West Sahara Ave., PMB 158, Las Vegas, NV 89117.

E-mail: thespectrum@thespectrumnews.org

DONOR INFORMATION

The SPECTRUM is a 501(c)(3) non-profit educational corporation. All donations are gratefully appreciated and formally acknowledged for your tax-deduction purposes. Thank You Very Much!

CHANGE OF ADDRESS

Either send your old address label along with your new address to us 30 days before you move, to: *The SPECTRUM*, P.O. Box 1567, Tehachapi, CA 93581. Or call us toll-free at 1-877-280-2866 (PREFERRED METHOD).

WEBSITE: www.TheSpectrumNews.org

THE NEWS DESK

Items You Won't Want To Miss

6/7/03 DR. AL OVERHOLT

(alo@thespectrumnews.org)

IT'S PERFECTLY OK TO LIE IN THE PRESS

From the www.sierratimes.com website,
2/28/03: *[quoting]*

Appellate Court Rules
Media Can Legally Lie

by Mike Gaddy

On February 14, a Florida Appeals court ruled there is absolutely nothing illegal about lying, concealing, or distorting information by a major press organization. The court reversed the \$425,000 jury verdict in favor of journalist Jane Akre who charged she was pressured by Fox Television management and lawyers to air what she knew and documented to be false information. The ruling basically declares it is technically not against any law, rule, or regulation to deliberately lie or distort the news on a television broadcast.

[end quoting]

What more insightful lesson on moral decay could we possibly share as a reminder about why *The SPECTRUM* exists?!

And then consider this professional excuse, excerpted from the www.wsws.org website, 5/17/03:

[quoting]

No Iraqi Weapons Of Mass Destruction?
U.S. Media Scoundrel Shrugs
His Shoulders

by David Walsh

The pollution of the American body politic continues unabated. U.S. media pundits, whose lies about Iraqi “weapons of mass destruction” have been exposed by events, are rapidly inventing new falsehoods to justify the old ones.

Michael Schrage, a “senior adviser to the Security Studies Program at the Massachusetts Institute of Technology” has penned a column, published in the May 11 edition of the *Washington Post*, headlined: “No Weapons, No Matter. We Called Saddam’s Bluff”.

The First Amendment gives broadcasters the right to lie or deliberately distort news reports on the public airwaves.

Any other commentary is not needed.
[end quoting]

It’s not that readers of our publication didn’t know this already, but it’s almost refreshing when such an admission is now made matter-of-factly—especially when it comes to understanding why, a few months ago in Iraq, certain journalists lost their lives in curious “accidents” and others were prevented from further reporting.

FLOATING THE DOLLAR

From *Conspiracy Nation*, 5/29/03:

[quoting]

In the mid-1990s, Mexico decided to “float” its peso: allow the market to fix the price of the peso, instead of quietly intervening to support their currency. Ever since paper money was no longer backed by gold and silver, the value of each nation’s currency is relative to that of other nations’ currencies. The rise of post-modernism—“the truth is relative”—coincides with the abandonment of relatively stable backing (i.e. gold and silver) for paper money. But which came first? Did the truth first become “relative” and then the currencies became relative? Or did the currencies first become relative and then were mirrored by post-modernism?

In late December of 1994, foreign investors were nervous about the Mexican peso; their deposits made “a stampede for the exits”. (See *Conspiracy Nation*, “Behind The Immigrant Trailer Deaths”.) There was a financial crisis. It was decided to float the peso. This caused the value of the peso to decline relative to other currencies.

Also in the 1990s, the value of the dollar compared to the Japanese yen declined drastically, until the dollar/yen ratio sank below par to about 1 dollar equals 0.85 yen. But at that time the European currency, the euro, had not yet been inaugurated, so there was not such an attractive alternative haven as now.

Given the mid-90s dollar/yen ratio of

about 1/0.85, the current dollar/yen ratio of about 1/1.15 does not seem nearly as alarming. But this is because most people do not take into account the new currency, the euro, not available yet in the mid-90s.

“John Snow, the U.S. Treasury Secretary, has signaled that Washington was content to let the dollar slide.” (“Soaring Euro Poses Economic Threat” by Gary Duncan, *Times Online* (U.K.), 5/28/03.) Take your pick: Snow’s recent comments were—just stupid. Snow put his foot in his mouth and his comments were meaningless; a shot across the bow, a warning to Europe to behave “or else”.

Washington has decided to float the dollar. According to an article by Jay Hancock (“Economic Stealth Attack Takes Revenge On France”, *sunspot.net*, 5/25/03), Treasury Secretary Snow basically stated that: “The dollar is strong if it can’t be counterfeited.”

Given reports by Chicago independent reporter Sherman Skolnick [*whose commentaries appear regularly in The SPECTRUM, including what is mentioned here*] regarding a sophisticated counterfeiting scheme threatening the dollar, Snow’s statement that “the dollar is strong if it can’t be counterfeited” might be more than ironic.

Indications crossing the desk of *Conspiracy Nation* are beginning to buttress Skolnick’s original report. For example, there has been a frantic upgrade to multi-colored paper for the U.S. dollar as a way to thwart possible dollar-hackers who have already cracked an embedded picture counterfeiting-prevention device.

“This is the beginning of the bear market for the dollar, which is still being propped up by massive intervention around the world...” reports Gary Duncan (“Soaring Euro Poses Economic Threat” by Gary Duncan, *Times Online* (U.K.), 5/28/03.). [end quoting]

The fall of the dollar would “only” be the latest casualty in a world economic collapse that is simply proceeding slowly enough so that the Big Boys can gather as much loot as we suckers are willing to give up (“Experts say: ‘Keep investing in the markets.’”), and then run for financial cover before the roof falls in on the little guy.

DESPERATE TO POSTPONE THE HOUSING CRASH

From the *www.321gold.com* website, 5/30/03: [quoting]

Washington Post: Mortgages Hit Another Low Friday, May 30, 2003; Page E02

Rates on 30-year mortgages have

dropped to a new low, the eighth time this year that has happened. Average interest on a fixed-rate 30-year mortgage fell to 5.31% this week, the third week in a row this benchmark mortgage hit a record weekly low, Freddie Mac, the mortgage company, reported in its nationwide survey....

Are They Seeing What Is Coming Dead Ahead? Anatomy Of A Real Estate Crash

by Clif Droke, *Publishing Concepts*, May 30, 2002:

The last great financial bubble to blight the American economic landscape that has not yet popped, the real estate bubble, should realize its peak sometime this year and by no later than the first quarter of 2004. It will be my intention to prove this assumption using detailed cycle analysis and other forecasting methods in the article that follows. While Americans have enjoyed a generational speculative mania in the “ultimate” personal asset, namely housing, the doormat will soon be ripped out from under them as the bear continues to work out its vicious assault on everything the public holds dear....

[end quoting]

Unfortunately, it will take the collapse of this most sacred cow of the consumer-investor before many believe the truth about our ailing economy. Those of you who have been following Al Martin’s commentaries regularly in *The SPECTRUM* have a very good idea of how this collapse is being helped (rushed!) along by the Bush Administration’s Bushonomics.

WILL NEW U.S. BANKING SYSTEM THREATEN THE FED?

From the *www.washingtonpost.com* website, 5/22/03: [quoting]

Firms’ Push To Enter Banking Wins Hill Support Brokerages And Retailers Would Operate Without Fed Oversight; Greenspan Is Among Critics

by Kathleen Day

Merrill Lynch, Morgan Stanley, Wal-Mart, General Electric, and other companies are gaining support in Congress for the right to set up a nationwide banking system that could compete with commercial banks but operate under looser federal rules.

Consumer groups, bankers, some lawmakers, and Federal Reserve Board Chairman Alan Greenspan have sharply criticized the effort, saying it would create a second, parallel banking system that would result in unfair competition and more risk for the federal deposit insurance system and possibly taxpayers....

At issue is whether Congress should expand the power of obscure entities known as industrial loan companies. These state-chartered, limited-purpose banks—which operate in Utah, California, Colorado, Nevada and Minnesota—generally specialize in one area, such as offering credit cards. The owners of these companies are not regulated by the Federal Reserve and may include automakers, discount department stores, and other firms that are largely unrelated to financial services.

The House Financial Services Committee has passed two bills that would allow the giant Wall Street and retail firms to transform their industrial loan companies into full-blown banks. For example, Merrill Lynch would be allowed to open full-service branch offices around the country that could

ATTENTION: 6-MONTH SUBSCRIPTION

We are now offering a **6-month** subscription, which provides a great way to introduce *The SPECTRUM* to friends and family—as a gift for birthdays, holidays, or other special occasions. This is also a way to ease the stress on a tight budget. Our subscription rates are as follows:

6 issues = \$25 U.S. / \$30 Canada / \$35 Foreign
12 issues = \$45 U.S. / \$55 Canada / \$60 Foreign
(Note: All prices are in U.S. dollars.)

Please call for bulk subscription rates.

For orders (U.S. & Canada) call toll-free: **1-877-280-2866**
Otherwise call: **1-661-823-9696**

accept deposits, cash checks, and pay interest on accounts for individuals and companies....

A second bill, passed by the committee this week, would make it possible for industrial loan companies to set up branch offices nationwide without seeking states' permission. Currently they cannot do that in most states.

Greenspan, in a letter to Rep. Michael G. Oxley (R-OH), chairman of the House Financial Services Committee, said the changes "would alter the structure of banking in the United States and be contrary to two important national policies" one prohibiting non-financial companies, such as Wal-Mart, from owning a bank, and one that gives the Federal Reserve responsibility for ensuring that "companies that own federally insured banks operate in a safe and sound manner."

The American Bankers Association is against giving the industrial loan companies new powers without Federal Reserve supervision. The Federal Reserve is worried that if the bills become law, companies that have full-service banks, such as Citigroup, might drop their regular bank charters and move their operations into their industrial loan companies to avoid Fed scrutiny, according to Fed sources. Citigroup declined to comment....

Executives at Merrill, Morgan, and Goldman say they do not want to be regulated by the Federal Reserve Board, because they think it is overly restrictive. For example, if they are under the Fed, most security companies would have to hold more capital as a potential cushion against loss than they currently have to hold....

Critics say the issue for them is potential conflicts. "Without proper oversight, a commercial company might be tempted to use an industrial bank as a personal piggy bank and endanger the safety and soundness of the bank" said Travis Plunkett, legislative director of the Consumer Federation of America. Plunkett said it was ironic that Merrill Lynch, Morgan Stanley, Goldman Sachs, and UBS were pushing to expand the power of industrial loan companies—and are embracing the state of Utah as a primary regulator that could help set national bank rules.

Last month, these firms were among ten Wall Street firms that paid \$1.4 billion to settle state and federal charges that they had cost individual investors billions of dollars by issuing inaccurate, overly rosy stock research reports to win investment banking business. These firms continue to decry a probe by New York state that led to the settlement because they say state officials should not be

setting rules for a national and global industry.

"We think it's a particularly bad idea that the companies pushing this are investment firms: Given everything we know about how poorly investment firms have handled conflicts of interest in recent years, why would we make it easier for them to skirt federal restrictions?" Plunkett said.

[end quoting]

While all this fighting is going on among different factions of the elite controllers for "king of the hill" of the money pile, you can be sure of one thing: NONE of it is meant to help the average person who just wants an honest bank to deal with. Should anybody decide to go the route of true service, without all the ridiculous fees that banks are presently slapping on us right and left, well—look out—there'll be a mob beating a path to their door!

BAYER AGREES TO PAY U.S.
\$257 MILLION IN DRUG FRAUD

From the *www.nytimes.com* website, for 4/17/03: [quoting]

In the largest Medicaid fraud settlement, Bayer agreed yesterday to pay the government \$257 million and pleaded guilty to a criminal charge after engaging in what federal prosecutors said was a scheme to overcharge for the antibiotic Cipro. According to documents turned over to the government by a whistle-blower, Bayer was coached in the scheme by a purchasing manager from Kaiser Permanente, one of the nation's largest healthcare organizations. The fraud involved selling Cipro to Kaiser at prices lower than the company was charging Medicaid, in violation of a federal law that requires drug makers to give the Medicaid program the lowest price charged to any customer. To cover up the fraud, the Cipro bottles sold to Kaiser were relabeled with Kaiser's name and given a different drug identification number.

[end quoting]

If Bayer got this large a fine, how high would you estimate the real theft was—knowing how the Big Boys always profit from their thefts even if they put on a token morality play for our benefit?

And do you really think the taxpayers will receive any benefit from this "fine" or will it just be a shuffling of funds between the pockets of different factions of thieves?

And speaking of robbers of the type our front-page feature story points out this month, how about the following

item, which follows from the Press Release on page 27 of last month's News Desk, which said "Doctors Make Natural Treatment For SARS Available Worldwide":

DR. HOROWITZ REFUTES
FTC CHARGES OF ILLEGALLY
MARKETING SARS CURE

Excerpted from *www.tetrahedron.org*, 5/13/03: [quoting]

Subject: Urgent Open Letter from Dr. Len Horowitz

RE: SARS, FDA, and FTC
May 12, 2003

Federal Trade Commission
Bureau of Consumer Protection
Washington, D.C. 20500

Dear Commissions and Bureau of Consumer Protection Officials:

This open letter is in response to the e-mailed notice that you sent to our customer service representative at *www.cureforSARS.net* wherein you wrote: "The Federal Trade Commission staff has reviewed marketing claims on your website..." and "we remind you that the *FTC Act* requires that health-related claims...[for] SARS must be supported by competent and reliable scientific evidence at the time the claims are made."

This provides you with notice of three health-related claims that we are making regarding SARS and our Internet communications:

(1) The scientific evidence supporting our justifiable claims regarding the utility of a plant-based formula for SARS is available on our website (*www.cureforSARS.net*) based on the scientific publication by Towers, et al. (1995) from the *Journal of Ethnopharmacology*;

(2) We do not recognize the FDA, or your "commission" in collaboration with them, pursuant to this notice, as anything other than irresponsible, misplaced, and misdirected authority; and

(3) the insidious economic motive behind your political notice is transparent among well-educated consumers and natural healthcare investigators and providers.

Such commercial interference, allegedly on behalf of American consumers and public health, is rooted in the advancing Anglo-American global Codex Alimentarius legislation that seeks to control all non-patent-protected natural cures and treatments on behalf of multinational drug companies (best termed the "global petrochemical-pharmaceutical cartel"). In other words, we view the FDA's widely publicized persuasion campaign attacking natural

healing practitioners and formula manufacturers as a real life enactment of the *Wizard Of Oz*. Pull back the curtain and behold who profits from pulling strings on your commission, and the FDA overstepped authority.

We notice that responsibility for your electronic notification was signed, not by a person, but by your non-human organization/entity. For your information and official notification, we only respect and respond to real people. As sovereign individuals subservient to only one Creator, we rebuke any and all misplaced authority in your "commission".

We do this cognizant of rapidly advancing multinational corporate efforts increasingly administered through the World Health Organization (WHO), affecting global drug sales, healthcare policies, and contrived declarations of urgencies directed against nation states to compel compliance with neocolonialistic politics, policies, and interventions inconsistent with personal freedoms and democratic governments.

Your transparent efforts may be effective in deceiving the general population, but most of us in the natural healing arts and sciences are not fooled or frightened by your threats. Most members of our allied organizations view as inexcusable, if not despicable, increasing German-American political efforts to suppress natural healing methods and materials.

This includes new SARS treatments and potential cures at a time of global urgency when, in fact, government health officials in the hardest hit nations, including China, Hong Kong, Singapore, and Taiwan, have been embracing herbal and plant-derived natural medicines for the prevention and treatment of SARS.

We notice your commission and the FDA turns a blind eye to the promotion and use of the experimental, expensive, and highly toxic drug Ribavirin, never tested against the SARS-associated coronavirus, yet widely promoted as the standard for SARS patient care since before anyone knew the illness was linked to a coronavirus.

Reflecting on the FDA's and your commission's official tolerance of this harmful, if not lethal, practice by the mainstream media and medical doctors treating SARS patients adequately exposes your hypocrisy. American tax dollars would be far better spent having your commission and the FDA address the third leading cause of death in the United States—iatrogenesis, that is, physician-induced illnesses and lethal drug side-effects. How do you have the audacity to virtually disregard this pervasive public

health threat, yet proclaim throughout the media our natural healthcare industry's shortcomings?

What is most sad is your organizations' manipulation of the average American who does not comprehend this joint FDA/FTC attack for what it really is—simply a promotion to facilitate a form of nutritional and pharmacological slavery through a political and economic drug agenda called Codex Alimentarius.

In recent years the global drug cartel has sought to pirate and patent anything uncontrolled in Nature's bounty. Examples of this, in recent months, include further violations of freedom of choice with declared restraints on ginseng production and the classification and labeling of stevia—the natural therapeutic sugar substitute—as a regulated "nutritional supplement" rather than a food.

Beyond these reasons for our disregard of your authority, there are many more egregious violations of human rights perpetrated by those with whom you are associated. One example involves the origin of HIV/AIDS and the FDA's apparent role, in collaboration with the Merck pharmaceutical company and the Centers for Disease Control and Prevention (CDC), having cooperatively produced the 1974 Hepatitis-B vaccines tested on gay men in New York City and Central African Black women. According to the most recent scientific evidence cited and discussed at www.originofAIDS.com, this collaboration played a major role in triggering the international AIDS pandemic.

In conclusion, we will not be intimidated, coerced, or corrupted by your drug company collaborating, administration, and/or commission.

We understand that mostly well-meaning persons within your ranks have been persuaded, largely by deception, to act as agents on behalf of the above-named global menaces. We simply rebuke your misdirected, politically contrived authority, yet remain open to serving your policy-makers by sharing in every way possible, the uncommon intelligence required to expose and arrest the "Wizard of Oz behind the curtain" for the sake of world health and the public's protection.

Very truly yours,

Leonard G. Horowitz, D.M.D., M.A., M.P.H.

[end quoting]

Dr. Horowitz could have easily written a much longer response that traced the historical roots of this longtime intimidation scam. And don't forget the

SPECIAL REQUEST

Dear *SPECTRUM* readers and Wisdom Books customers: PLEASE use our toll-free ordering line for ORDERING ONLY.

If you need to call for any other reason, please call our regular phone number at:

1(661)823-9696

Thank you and God Bless,
Gail Cortright
Business Manager

classic research volume by Eustace Mullins titled *Murder By Injection* about how the medical mafia got started.

Remember: They get away with such bullying because they can—until we stand up and put a stop to it!

Which leads to this next item. As you read the following, keep in mind the vast pill-pushing scam that the pharmaceutical empires carry out through brainwashed MDs:

PRESCRIPTION FOR VIOLENCE? GEBAUER CASE DRAWS NOTICE OF GROUP LINKING CRIME, ANTIDEPRESSANTS

From the www.post-gazette.com website, 6/1/03: [quoting]

by Joe Smydo, *Post-Gazette* staff writer

Looking to bolster a theory linking antidepressants to adolescent violence, a group that studied the Columbine High School massacre has decided to follow the John Gebauer murder case.

The International Coalition for Drug Awareness—counting dozens of cases in which juveniles reportedly hurt themselves or others while taking prescription drugs such as Paxil, Prozac, Celexa, and Luvox—wants Congress to hold hearings on whether the antidepressants are appropriate for young people.

Through monitoring of newspapers and the Internet, group members built a bank of cases to advance their claims. In the process, they became aware of Gebauer, 16, charged last year with fatally shooting his adoptive mother, Alison, and sexually abusing her corpse at the family's Fallowfield farm.

Gebauer, who faces a preliminary hearing June 18, acknowledged taking an antidepressant in an October 2000 school essay he wrote about his family life. He

didn't identify the drug.

Washington County [*Pennsylvania, near Pittsburgh*] assistant public defender Thomas Cooke said Gebauer had been prescribed Prozac before coming to live with Alison and Edward Gebauer, who adopted him in 1999, but didn't know whether his client ever took the drug. Washington lawyer David DiCarlo, Gebauer's court-appointed guardian, declined comment.

Ann Blake Tracy [*the front-page feature story for our July 2000 issue, titled **The Ticking Time Bomb—PROZAC—Prescription For Disaster***], the coalition's executive director, said Prozac and other antidepressants can induce a state in which adults or juveniles act out their "worst nightmares". Tracy said she founded the nonprofit group in Salt Lake City, Utah, about 10 years ago to educate people about the risks and described teenagers as particularly vulnerable because of their developing minds and bodies.

She said Prozac, Luvox, and Paxil belong to a family of drugs that, in fighting depression, restrict the brain's ability to metabolize the chemical serotonin. The coalition's website (*drugawareness.org*) says serotonin "is the same brain chemical that LSD, PCP, and other psychedelic drugs mimic in order to produce their hallucinogenic effects".

In some people, Tracy said, violent tendencies occur during use of the drugs and during withdrawal. If people aren't weaned from the drugs slowly, she said, violent behavior can linger for months or years.

"It begins to subside, but it can continue" she said.

A spokesman for the Pharmaceutical Research and Manufacturers of America could not be reached for comment. But drug companies have refuted the coalition's claims and similar arguments by lawyers who took the companies to court.

Lisa Van Syckel, the coalition's New Jersey director, said she called Cooke last month after Common Pleas Judge Katherine B. Emery rejected Gebauer's motion to have his case heard in juvenile court. She said she wanted to alert Cooke to the drugs' effects on some people and speak about cases the group had investigated, including the 1999 Columbine massacre of 12 students and a teacher by trenchcoat-clad teens Eric Harris and Dylan Klebold.

"I know the Eric Harris file like the back of my hand... I now understand how Columbine could have occurred" Van Syckel said, referring to the

gunman's use of Luvox.

Cooke said he's willing to consider Van Syckel's information but doesn't know how, if at all, the group's concerns would fit into a defense strategy for Gebauer. He said he doesn't know whether there's a conclusive scientific basis for the theory of antidepressant-induced violence or whether it would be possible to isolate a drug's effects from the effects of a traumatic childhood.

Gebauer, 15 at the time of the shootings, lost his biological mother to cancer when he was 7. His father was out of his life by then, and the child was shuffled between foster homes for years before the Gebauers decided to adopt him.

Cooke said he still needs medical records to determine when Gebauer took Prozac, if at all. He said it doesn't appear Gebauer took an antidepressant while living in Washington County.

Van Syckel said she would consider traveling to Washington for Gebauer's trial.

The notion of antidepressant-induced violence has been introduced in court with mixed results.

Van Syckel said she helped Mark Taylor—wounded multiple times by Harris—to file suit against Luvox manufacturer Solvay Pharmaceuticals. In February, Taylor settled for a \$10,000 contribution to the American Cancer Society.

Two years ago, a federal jury in Cheyenne, Wyoming, ordered Paxil maker GlaxoSmithKline to pay \$6.4 million to relatives of a man who fatally shot his wife, daughter, granddaughter, and himself after 48 hours on the drug. It was the first major victory in such a case, with the jury finding the drug primarily responsible for the violence, said the plaintiffs' lawyer, Andy Vickery of Houston, Texas.

Vickery reached an undisclosed settlement for Melvin J. and Diane V. Cassidy of Monroeville, Allegheny County [*a suburb of Pittsburgh, Pennsylvania*], in their lawsuit three years ago against Prozac maker Eli Lilly and Co. The suit alleged Diane Cassidy attempted suicide because of the drug.

While Tracy blames the drugs' impact on serotonin levels, Vickery offered a somewhat different theory. He said a small percentage of people may have difficulty metabolizing the drugs and act aggressively when the medications build inside them.

Vickery, who chronicles some of his cases on the website at *justiceseekers.com* said drug companies are liable because they haven't adequately warned consumers about the danger.

Some lawyers also have assailed the drugs in criminal cases.

Psychiatrist Peter R. Breggin says on his website (*breggin.com*) that his expert testimony persuaded a South Carolina judge to reduce the sentence of a man who committed rape after taking Paxil and a Virginia judge to reduce the sentence of a man who shot his wife and a sheriff's deputy after taking Prozac and other drugs.

Columbine is one of many cases the coalition cites in letters to elected officials demanding better regulation of the drugs. One case hits close to home for Van Syckel, who said her family's story will be told in the August issue of *Good Housekeeping* magazine.

She said she became active in the coalition after her daughter, Michelle, a high school senior, four years ago complained of ill health, mistakenly was diagnosed with depression and was prescribed a variety of antidepressants. Van Syckel said she saw sweeping changes in an honor-roll student who spoke French fluently, had no history of drug or alcohol abuse, and hailed from a stable family.

She said her daughter cut herself dozens of times with knives, razors, and jagged pieces of compact disc cases. "She even cut the word 'die' in her abdomen" and threatened to kill her mother with an ax, Van Syckel said in a July 30 letter to President Bush that urged him to act on her concerns about the drugs.

Van Syckel said her daughter had Lyme disease, not depression, and was evidently infected by a tick when the family settled in New Jersey after living five years in Belgium.

Meanwhile, the Van Syckels have sued the doctors who misdiagnosed Michelle and the hospitals where she was treated. The case has not been resolved.

"Her beautiful smile and wonderful disposition have returned, and she has been treated for her Lyme disease" Van Syckel told Bush. However, the letter said Michelle has irreversible brain damage and other problems.

Van Syckel said she wasn't satisfied with Bush's response, which arrived in the form of a letter from a U.S. Food and Drug Administration official who asked the family to file a formal report about Michelle's reaction to the drugs. On a more positive note, she said, a handful of congressmen have come out in support of hearings on the issue.

U.S. Rep. Tim Murphy, R-Upper St. Clair [*another Pittsburgh, Pennsylvania suburb*], a child psychologist who took office in January, said he did not know whether his office had been contacted by

the coalition. But Murphy, co-chairman of the Mental Health Caucus, said he's willing to listen.

"I'll certainly review anything they send to me on that" he said.

[end quoting]

Longtime readers of *The SPECTRUM* are well aware of Dr. Ann Blake Tracy and her powerful book *PROZAC: Panacea Or Pandora?* which we first featured in September 1999—almost a year before our eye-opening July 2000 feature interview with her. Naturally the large pharmaceutical companies, making handsome profits from pushing these drugs, are denying any such correlations as Dr. Tracy has so shockingly and consistently documented. These drugs seem to cause aggressive and sometimes downright bizarre behavior, yet so many of them are being dispensed to children and young adults like candy.

Of course, as many readers of *The SPECTRUM* would be quick to point out, from the larger perspective this pill pushing is part of the elite world controllers' strategy for neutralizing many gifted, advanced beings incarnating into planet Earth at this time with an agenda to break the longstanding chains of slavery over the people.

And speaking of ones who have been exposing the world controllers like those called the Illuminati:

FRITZ SPRINGMEIER RAILROADED

From the www.rumormillnews.com
Reading Room Forum, 4/28/03:

[quoting]

Posted By: Novice

For the many who may be unfamiliar with this man and his work, the details about his books and video offer important information.

I received this message just as is from Virginia Brooks, Reform Party of Ohio, State Chair. I met Virginia at the We The People Congress event called Operation Enduring Patriotism which was held at the National Press Club in November 2002. We have stayed connected. She has been given permission by Patricia Springmeier to spread this information far and wide.

I am surprised that this book is available. I thought that the Illuminati had done everything that they could to prevent it's distribution. I have no idea as to the validity of Arizona Wilder's work. In this forum, I have read of the skepticism concerning Kathy O'Brien's material. I hope that those Agents who can offer valid critique of Fritz Springmeier's work and/or Arizona

Wilder's work will do so for the Rumor Mill News Readers. Many of us just don't have the connections, background, or knowledge. Thank you. — Novice

* * *

From Virginia Brooks:

Please help this wonderful patriot in buying his book, one of the most outstanding books you will ever read!

Fritz's book will show you what the Reform Party is fighting against. Fritz had the guts to put it into print, and I truly believe that was why he was targeted, put into prison, to shut him up. But let's not let that happen in vain. Buy the book; you will never be sorry for the knowledge you will have access to by reading his great book. And if you can, make a donation too. Thanks.

— Virginia Brooks

P.S. Please pass this on to everyone you know, who realize what is happening and why it is happening! Fritz has and is paying the price for getting this information out for the salvation of our great country. Please don't let him down!

Please read his story below.

Dear Friend:

You are being contacted on behalf of my husband, Fritz Springmeier, who has been framed by several criminals in exchange for outrageous plea bargains.

Fritz unfortunately made the acquaintance of some of these people through ministering to them through Bible study sessions. (He has ministered to Jehovah Witness, mind-control victims, and many others since the early 1980s.) This email is being sent to knowledgeable and aware people with the hope that we can fight this injustice together. First, allow me to fill you in on the trial.

Fritz's Trial

The proceedings seemed unreal as I sat there and watched as defense revealed that the principal witness for prosecution, Tony Huntington, when faced with approximately 130 years on various weapons and drug charges—received a paltry 2-½ year sentence as a plea agreement for testifying against my husband!

Furthermore, our side had learned from the attorney for Forrest Bateman (a man who had pled guilty to the robbery) that Huntington had actually taken an active role in the bank robbery on the day of the robbery. When pressed by defense cross-examination, Huntington finally admitted to this—thus, impeaching his

own testimony and perjuring himself! The most unfortunate thing about this was that, because Bateman was still awaiting sentencing, he was unable to testify.

Another witness against Fritz, Jim Vermeer, had five years for marijuana cultivation reduced to two. When confronted with statements recorded by a BATF interviewer that, within days of the robbery in question, Bateman told Vermeer that Scotty (AKA Simon Elliot) helped him do "it" (the bank robbery)—Vermeer said that Bateman meant prior bank robberies. When actually shown the written statements by Fritz's defense attorney, Pat Birmingham, Vermeer said that the BATF interviewer got it wrong. (Oh really!)

Worse still, was the testimony given by Simon Elliot (AKA Scotty). When approached by FBI interviewers offering leniency in exchange for information, Elliot received a signed guarantee by the agents that the statute of limitations for bank robbery was five years. At this point, Elliot admitted to committing seven bank robberies. He proceeded to give the names, locations, and approximate date of six of these.

When he got to the seventh, his memory had somehow failed. Is it possible that Elliot suddenly realized that the seventh robbery—the one that Fritz ended up getting indicted for—had not yet passed the five-year mark? These and other idiosyncrasies were all brought to light through defense cross-examination.

It seemed as though prosecution didn't

Colloidal Silver Handbook

COLLOIDAL SILVER GENERATOR

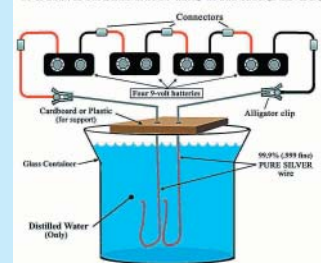

Why You Need It How To Make It

44-page booklet

\$7 (shipping included)

Code: COL (0.5 lb.)

See next-to-last page for ordering
or call toll-free: 1-877-280-2866

DR. CHET SNOW'S SIGNS OF DESTINY. CROP CIRCLES & SACRED GEOMETRY CONFERENCE PRESENTS:

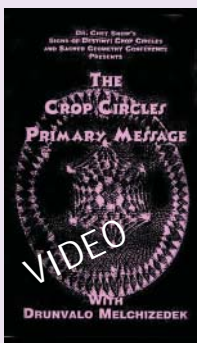

THE CROP CIRCLES: PRIMARY MESSAGE by Drunvalo Melchizedek.

As a celebrated mystic and teacher, Drunvalo Melchizedek's life experience reads like an encyclopedia of breakthroughs in human endeavor. After having taken physics and art at UC Berkeley, he ventured out, and over the last 25 years has studied with over 70 masters from all belief systems and religious backgrounds. An accomplished speaker, he instinctively communicates what's in his heart—his personal warmth, his love for life in all forms, and his deep compassion for humanity. His "Flower of Life" teachings and "Mer-ka-ba" meditation system have helped thousands better understand their own history and life work. An expert on Sacred Geometry, he has studied how Crop Circles manifest these ancient forms for a decade.

VHS video – 118 min.
\$19.95 (+S/H)
 Code: CCMV (1.0 lb.)

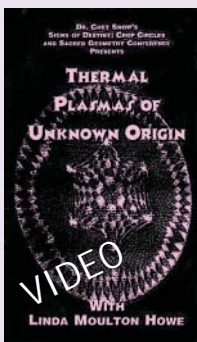

THERMAL PLASMAS OF UNKNOWN ORIGIN by Linda Moulton Howe.

An Emmy-award-winning investigative journalist and author, now living near Philadelphia, Linda was the creative genius behind the original *Sightings* TV series. For several years she has provided millions of listeners with a weekly UFO update and summary at the beginning of the *Dreamland* radio show and has done numerous guest appearances on Art Bell's *Coast-to-Coast* late-night show. One of the most serious and respected investigators of the paranormal, her interests include alien abductions, animal mutilations, crop circles, and ET contacts. This lecture focuses on her latest research into the mysterious plasma and glowing-orb effects found in a remote valley in Hessdalen, Norway.

VHS video – 54 min.
\$19.95 (+S/H)
 Code: TPV (1.0 lb.)

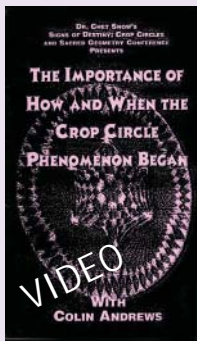

THE IMPORTANCE OF HOW AND WHEN THE CROP CIRCLE PHENOMENON BEGAN by Colin Andrews.

One of the earliest and best-known crop circle researchers and authors, Colin became involved in this mystery when, in 1983, he saw a quintuplet formation near his home in Andover, England. An electrical engineer by training, he was intrigued about what forces could create such perfect glyphs in crop fields. In 1989 he and Pat Delgado wrote *Circular Evidence*, a best-seller, followed by *Crop Circles: The Latest Evidence*, a year later. Colin founded Circles Phenomenon Research International (CPRI) and later moved to Connecticut. His scientific investigations have been widely recognized as models in the field and he has been featured in many crop circle documentaries. Recently, he has stated that while he considers many complex formations to be man-made, one cannot rule out unknown paranormal involvement in the rest.

VHS video – 92 min.
\$19.95 (+S/H)
 Code: CCPV (1.0 lb.)

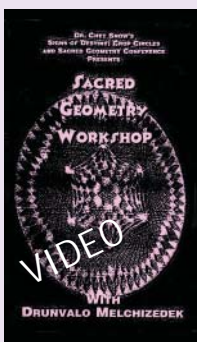

SACRED GEOMETRY WORKSHOP by Drunvalo Melchizedek.

Drunvalo's information was given to him from 1972 through the 1980s by Thoth, best known as the Egyptian deity of inner wisdom pertaining to science, mathematics, and literature. Since the 1980s, Drunvalo has been presenting his Flower of Life Workshops (either personally or through his trained facilitators). His work has been spread to at least 40 countries, is taught in many languages (such as Spanish, Dutch, German, French, Japanese), and has deeply touched thousands of people around the globe. When the teachings of geometry are used to show the ancient truth that all life emerges from the same blueprint, we can clearly see that life springs from the same source—the intelligent, unconditionally loving Creative Force some call "God". When geometry is used to express and explore this great truth, a broader understanding of the universe unfolds until we can see that all aspects of reality become sacred. The ancients, such as the Egyptians, Mayans, and others all knew this truth and incorporated sacred geometry teachings into their mystery schools as a way for anyone to begin to practically understand his or her personal relationship to "God" and the universe. In this presentation, Drunvalo speaks on the experience in his life that led him on the path to practicing the Flower of Life teachings. A full two-hour presentation on the Flower of Life and sacred geometry.

VHS video – 118 min.
\$19.95 (+S/H)
 Code: SGV (1.0 lb.)

SEE NEXT-TO-LAST PAGE FOR ORDERING OR CALL TOLL-FREE: 1-877-280-2866

have much of a case. Later that evening when at home, Fritz's attorney, Pat Birmingham, telephoned Fritz and suggested that there was no need to call any of the witnesses for defense. At Fritz's urging he then promised to call at least two of the twenty defense witnesses.

The next day, Birmingham called none of the twenty witnesses for the defense. All the jury knew of Fritz were lies, rumor, and hearsay, and that's what they took with them into deliberations.

Thus, on February 12, 2003, Fritz was found guilty of bank robbery. Appeals are in process now and sentencing will be passed on June 15, 2003. This is why I must work quickly while there is still time to fight.

Fritz's Books

Anyone who is not familiar with Fritz might ask: "Why would they want to frame Fritz Springmeier?"

Those who are familiar with his work would say: "Because of his books."

Fritz has spent most of his adult life exposing the Illuminati, their false religions, and their total mind control. His third book, *Bloodlines Of The Illuminati* is now in print. This book, the first of three volumes, exposes the "who", "what", and "when" of the Illuminati and their ancient plans for a New World Order. (The second and third volumes, co-authored with ex-Illuminati Mother of Darkness, Cisco Wheeler, exposes "how" the Illuminati have maintained control over their own people through the use of total mind-control programming.)

A Call To Action

This letter is a request for help with Fritz's defense fund. We cannot allow the establishment to "railroad" Fritz into jail. We need money to pay for transcript evaluations and other legal expenses while there is still time to fight.

- If you know of retailer who would like to sell Fritz's books, please have them contact or email me at one of the addresses provided.

- To purchase more copies of *Bloodlines Of The Illuminati*, or any of the other books and video tapes by Fritz Springmeier, see later on in this letter.

- To purchase more copies of *Bloodlines Of The Illuminati* by credit card, you may do so online by visiting our website at the www.penttracks.com/bloodlines/bloodlines.htm Internet location.

- To send a donation via snail mail—make the check payable to me and send to the below address.

- To send a donation online through

PayPal—go to the www.paypal.com website. Sign up for an account (unless you already have one); press the tab that says “Send Money” and key in my email address. Please fill in the text box to let me know what it is for.

Many thanks for whatever you are able to do. Your efforts will be greatly appreciated. Sincerely, Patty Springmeier

Bloodlines Of The Illuminati

This latest edition includes:

- A Genealogy Chart Showing How 25 American Presidents are Related
- An Expose of Wolf’s Head Society
- A Photo of the Illuminati’s secret Mother of Darkness Castle
- Artwork by an American Mother of Darkness

And much, much more.

If you liked the first or second editions, you’ll love this new 7"x10", 544-page new edition even more. The book is offered at the low price of \$24.95. A great book at a great price.

Other books:

Vol. 2—The Illuminati Formula Used To Create An Undetectable Total Mind-Controlled Slave

This classic was the first book to really expose the total mind-control that is turning our entire nation into just one big mind-control lab. 500 pages. (\$69)

Deeper Insights Into the Formula

This is the sequel to the *Vol. 2 Formula* book. This sequel has many pages devoted to the solutions and how help comes for victims of the Illuminati’s total mind-control. 600 pages plus numerous color illustrations. (\$79)

Ezekiel 6:3 Spiritual Warfare

This book explains the where and when Illuminati rituals take place, and lists hundreds of coven addresses in the U.S. It also explains the spiritual mechanics that the Illuminati use, and Christian responses to bring healing to this nation. (\$14)

Video Tapes:

Understanding The World

This is Fritz’s best two-day seminar where he discusses such questions as:

What can be done to help our country?

What is wrong with the churches today?

How does the Illuminati control the world?

When did we lose our *Constitution*?

And many other important topics. The cost for the set of two tapes (12 hours of seminar) are \$50 plus \$5 for shipping.

Fritz’s Only Television Interview

This one-hour show was on public access television in Austin. It is an exclusive exception to his personal policy of not being on television. \$10

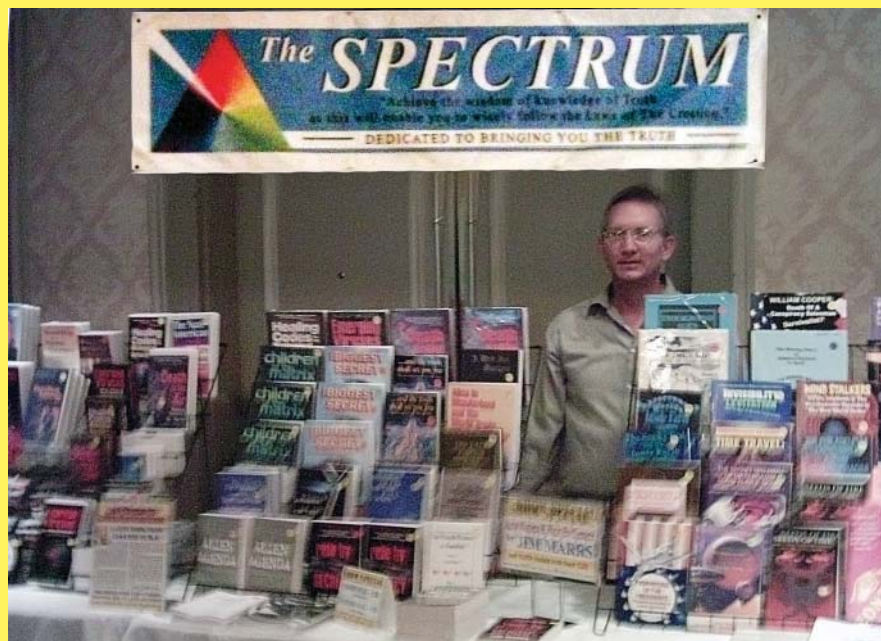

We have returned from *Conspiracy Con 2003*, held over Memorial Day weekend, May 24 & 25, at the Santa Clara Marriott Hotel, in the Silicon Valley area of Northern California.

The show was a success and we really enjoyed talking with many of you again, and some of you for the first time! We would also like to acknowledge and welcome our new subscribers. It is always a treat for us, Gail and Rick, when we speak with people from around the country (and around the world) who are finding out about *SPECTRUM*, or meeting us, for the first time.

It was also good to see and talk with some of the speakers, such as Arizona Wilder, Jim Marrs, and Jordan Maxwell. There wasn’t a dry eye in the house with Arizona’s lecture, which was the talk of the conference.

We would like to thank Brian Hall for producing another successful conference, and for creating such a user-friendly environment for us as vendors.

This show has been such a blessing in enabling us to reach so many more people than we would otherwise, who say, “I never knew such a great magazine existed!”

plus \$2 for shipping.

Mail your order to:

Patricia Springmeier

2870 NE Hogan Rd., E135

Gresham, OR 97030

Website: www.pentracks.com

Email: fritzspringmeier@pentracks.com

[end quoting]

Fritz has been a crusader for Truth for many years. Check David Icke’s website (www.davidicke.com) for more of the background on Fritz’s ongoing harassment, which began with a March 1, 2001 fraudulent raid on his property by “SWAT team storm troopers, ATF, and FBI agents”. Also be sure to send him supportive thoughts and prayers;

NOTHING is a more powerful force in counteracting the multi-dimensional aspects of the dark energies’ efforts to stop Fritz’s exposing of their longtime shenanigans on planet Earth.

OVERTIME PAY CUT

From the <http://www.aac.com> website, 5/12/03: [quoting]

A Bush Administration overhaul of decades-old labor legislation could force many Americans to work longer hours without overtime pay. The Administration argues that the pillars of U.S. labor law, which established the 40-hour work week, a minimum wage, and overtime pay, are

antiquated. According to the Labor Department, the changes would make more lower-income workers eligible for overtime. Unions fear the changes will severely restrict who is legally required to be paid for overtime.

[end quoting]

Again, see Al Martin's commentaries regularly shared in *The SPECTRUM* for further insights about the fallout from what he calls Bushonomics.

EDICT TO KEEP PIGS HAPPY

Excerpted from the <http://www.aacb.com> website, 5/15/03:

[quoting]

Farmers throughout the British Isles have 90 days to put a toy in every pigsty or face up to three months in jail. The new ruling, from the European Union, is designed to keep pigs happy and prevent them chewing each other. Official instructions are to give pigs "environmental enrichment" by providing manipulable material" which is being interpreted as balls of different colors.

[end quoting]

This is but a small token consideration, likely designed by a bureaucrat and based on economics, to offset the way modern agribusiness has made the farmyard life of chickens, pigs, cows, etc., so miserable.

HOW WE'VE HELPED IRAQ SO FAR

From *The Tehachapi News*, Tehachapi, CA, 5/21/03: [quoting]

Another View, by Norm Haughness

Some malcontents and spoilsports are saying that, despite the heroic photo op President Bush had, celebrating the end of the Iraq war by riding with three other men to a carrier landing in a Viking S-3B jet May 2, all's not well in that conquered land.

O, they of little faith. Iraq has freedom now. Can't the soreheads see that freemarket capitalism and religious fervor are now starting to bless the country lately locked in Saddam's cruel embrace? All those critics whine about is the destroyed infrastructure, the blasted roads and bridges, the bombed and looted schools, homes, hospitals, and museums that once made life livable in Iraq.

They complain that at gas stations where, until the Americans freed them, Iraqis could buy gasoline for about 7¢ a gallon, there are now mile-long lines of vehicles at the few pumps still working, motorists waiting dawn till dusk to get a few liters.

"Iraq's oil must benefit the Iraqi people" according to Mr. Bush. They'll

soon share the blessings of the \$2-a-gallon fuel we enjoy in America, courtesy of the U.S. oil companies on whose behalf Iraq was attacked.

Sure, it was necessary to destroy much of the country to save it from the barbarous Saddam. But we were forced to do it, and right away, to keep that dictator from using all his Weapons of Mass Destruction against us.

Okay, maybe no WMDs have been found. So far. But they're there. You know they are, because you have Mr. Bush's word for it, and you know his honest character from both his record at school and as a businessman and his valiant conduct during the Vietnam war.

Besides, it might not be wise to criticize too loudly. Bush's attorney general has already suspended habeas corpus in the United States and conducted many secret arrests and imprisonments without trial. So unless we want to risk being disappeared, like so many American residents of Islamic heritage [and many others], best to hold our tongues.

There's plenty more room in those cages at Guantanamo Bay and other undisclosed locations for people who express disloyalty by criticizing our leaders. If this column should suddenly cease to appear—but we won't get into that.

President Bush is, as he often boasts, a very religious man. So it's only to be expected that he encourage the reintroduction of religious control of all aspects of life (except oil production, of course) in newly liberated Iraq. Our good friend and ally, Saudi Arabia, where the mullahs rule everything and the oil flows unimpeded, will be the model.

The U.S. conquest is bringing back religion—the fundamentalist kind Mr. Bush prefers. Suppressed under Saddam, Iraq's majority Shiites were seen on TV recently marching by the thousands, streaming blood, having slashed their scalps with knives. More inspiring sights to come, as Iraqi women are returned to proper subjugation.

Why can't these impatient critics of the war on Iraq wait a year or two? Look at what we've accomplished in Afghanistan. There, the U.S. presence has brought a return to the order the Taliban once imposed. This is the Taliban we armed to defeat the awful Russians who were supporting a secular government.

Today, it's expensive to bribe the Afghan warlords not to attack the capital, Kabul, where our puppet, Hamid Karzai, huddles behind his U.S. Special Forces bodyguard. But it's calm there, and the same tranquility can soon be realized in Iraq, if only we give Mr. Bush and

Company a chance.

[end quoting]

This writer has captured the sentiments of many thinking Americans who can't articulate these same thoughts so powerfully. Perhaps his column WILL disappear soon, a casualty of the new federal laws in effect against badmouthing the government, a matter that Al Martin points out elsewhere in this issue of *The SPECTRUM*.

ID CARDS FOR ALL BRITS?

From timesonline.co.uk, 5/23/03:

[quoting]

ID Cards For All, In Battle To Track Immigrants

by Richard Ford, Home Correspondent

The Home Secretary is to legislate in the next session of Parliament for a national identity card to be issued to every adult living in Britain.

The move was disclosed yesterday as the Home Office released figures showing a sharp fall in asylum applications in the first three months of the year. In spite of the fall of 32% compared with the last three months of 2002, David Blunkett is to tighten asylum laws further with new measures in the autumn.

A Home Office policy paper, including a recommendation to proceed with the identity card, is likely to go to the Cabinet for agreement before the summer recess. Legislation would follow in the next session of Parliament, although the scheme would not be operating before the next general election.

The card, carrying a photograph, name, and address, would be voluntary, although without it citizens would find it difficult to get healthcare or education. It would also be used in an attempt to curb illegal working in the black economy. The ease with which people can find work in Britain is believed to be one of the reasons why the country is attractive to asylum-seekers and illegal migrants.

[end quoting]

Is the United States prepared to be next on the list after this experiment?

OPEN-MEETING PROVISION MAY BE CUT

From *The Daily News*, Los Angeles, for 5/20/03: [quoting]

by Naomi Kresge, staff writer

Gov. Gray Davis' latest budget proposes dropping a requirement that local governments make public the agendas, locations, and times of official meetings.

The law obligates the state to pay for something that local governments should feel duty-bound to do on their own and

produces no “significant benefit” to the state, according to Davis’ proposal.

Open-government advocates say the proposal diminishes the public’s access to government.

Some local governments said Monday that they would post agendas anyway, regardless of state reimbursement.

The proposal appears within a budget item that would save the state \$32.9 million by reducing reimbursements to local governments.

The governor’s revised budget does not specify how much of that money pays for the agenda mandate—the only state mandate within the item proposed for elimination instead of suspension.

State Department of Finance officials could not be reached for comment Monday afternoon.

The money-saving proposal leaves the door open for corruption in local government, government watchdog groups say.

“There were long fights to remove the secrecy in local government, and it’s not necessary today in the era of South Gate, Colton, Carson, San Bernardino to make it easier to conduct the people’s business behind closed doors” said Richard McKee, president of the California First Amendment Coalition.

Since 1986, the California open-government law, the *Ralph M. Brown Act*, has required that agendas be posted three days before each public meeting.

Advocates for open government say removing the requirement that local agencies tell the public what they will talk about before they talk about it cuts out the heart of the open-meeting law.

Cutting the requirement means that even if local governments post an agenda, they are not required to stick to it, said Thomas Newton, general counsel for the California Newspaper Publishers Association.

[end quoting]

California is likely a test case for this tactic to keep the public away from monitoring political shenanigans. Once it happens in California, then the rest of the states are likely to follow in short order unless the public kicks up a fuss.

HOW TO SURVIVE A HEART ATTACK WHEN ALONE

Sent to me via a reader from an Internet source, 5/27/03: [quoting]

Do read. This could save your life. Pass this on to everyone you know.

Let’s say it’s 6:15 p.m. and you’re driving home (alone of course), after an unusually hard day on the job.

You’re really tired, upset, and frustrated.

Suddenly you start experiencing severe pain in your chest that starts to radiate out into your arm and up into your jaw.

You are only about five miles from the hospital nearest your home; unfortunately you don’t know if you’ll be able to make it that far.

What can you do? You’ve been trained in CPR, but the guy who taught the course neglected to tell you how to perform it on yourself.

How To Survive A Heart Attack When Alone

Since many people are alone when they suffer a heart attack, this article seemed in order. Without help, the person whose heart stops beating properly and who begins to feel faint, has only about 10 seconds left before losing consciousness.

However, these victims can help themselves by **coughing repeatedly and very vigorously**.

A deep breath should be taken before each cough, and the cough must be deep and prolonged, as when producing sputum from deep inside the chest.

A breath and a cough must be repeated about every two seconds, without let up, until help arrives, or until the heart is beating normally again.

Deep breaths get oxygen into the lungs, while coughing movements squeeze the heart and keep the blood circulating.

The squeezing pressure on the heart also helps it regain normal rhythm. In this way, heart attack victims can get to a hospital.

Tell as many other people as possible about this; it could save their life!

[end quoting]

Surely the worst-case scenario is when you’re alone and something like a heart attack happens. Make sure your family and friends know about this technique.

257 CHILDREN MISSING IN 3 MONTHS

From *The Daily News*, Los Angeles, for 5/21/03: [quoting]

by Troy Anderson

Los Angeles County, which has one of the nation’s largest number of missing foster children, saw a further increase of 257 runaways and abducted children in the first three months of this year, according to a report released Monday.

That increase follows a county Department of Children and Family Services report in January that listed 990 children as missing since 1995, including 238 who had returned or been located.

As of Sunday, 759 foster children were still listed as missing.

“Clearly, we are at a critical point because this keeps happening” said Janis

NOTICE REGARDING CHANGES OF ADDRESS

Subscribers: please be aware that our current postal class of mail is **NOT** forwarded when you fill out a “Change Of Address” form at your Post Office.

As the CHANGE OF ADDRESS information box on page 4 instructs, please contact us as soon as possible when you change your address. This is the only way to be sure you’ll receive your magazine without interruption. **Calling us is the preferred method for handling your address change.**

We are sorry, but *The SPECTRUM* cannot absorb the additional costs of replacing missed issues due to not following this procedure.

We are investigating other mailing options that could allow for better service should our financial status improve. Thank you.

— *The SPECTRUM*

Spire, executive director of the Alliance for Children’s Rights. “The number of children showing up missing is not going down. I think one of the most disturbing things I read was that 75% of the runaways are teenage girls. That is an astounding number.”

The number of abducted children jumped from 21 in the last quarter of 2002 to 44 through March 2003. Also, 213 children ran away in the first quarter of this year, up from 194 in the last quarter of 2002. Of the runaways, 53 voluntarily returned or were located. A total of 11 children who were abducted were located or recovered.

Nationwide, 9,112 foster children were listed missing in March.

DCFS Director David Sanders said social workers need to spend more time with foster children and develop relationships with them so they can spot early signs of trouble.

“I’m concerned we are not spending the kind of time we need to with the child in the very beginning to actually prevent them from running away” he said.

Sanders said social workers are now visiting children once a month as required by a recent court order.

“I think it needs to be more than once a month” he said. “Not just ‘Hi, how are you doing?’ but to have a kind of relationship where the children can say ‘It’s not working. I’m thinking about running away.’”

By moving more administrative and management employees into social worker positions, Sanders said he could reduce the average caseload from 30 to 15 children, a ratio similar to other large child-protection systems in the nation.

“The number of cases is critical in that

it allows social workers to spend time with families” he said.

[end quoting]

Do you ever wonder why certain children are given so much publicity when they are missing, yet hundreds go missing every day under the government’s “protection” programs after many of them are literally stolen from their parents by the courts?

Of course, those of you aware of the secret satanic ritual abuse of children, by ones belonging to secret societies and often including some with jobs high up in government, already know the answer to why so many children are “missing” and why so little of substance is done about it!

FDA APPROVES SHOT TO NEUTER MALE PUPPIES

Excerpted from the *www.cnn.com* website, 5/20/03: [quoting]

Veterinarians now can offer an alternative to surgery to neuter puppies.

Called Neutersol, it’s a shot administered directly into the testicles of puppies at the right age for neutering. The ingredients—the amino acid L-arginine and a zinc salt—cause the testicles and prostate to atrophy.

The alternative, surgically removing the testicles, guarantees sterility. In a study of 224 dogs, Neutersol did almost as well: Semen analysis showed only one sterilization failure, said Dr. Melanie Burson of the Food and Drug Administration.

The FDA approved Neutersol in March, but did not announce the approval until Monday.

A type of chemical castration already is available for humans. Sex offenders often are sentenced to regular injections of hormones that deplete testosterone. But that’s not permanent sterilization.

The new method for dogs is permanent, but some testosterone production continues because it’s not hormonally driven, Burson said. So unlike surgical castration, Neutersol may not eliminate unwanted male behaviors such as roaming, marking, and aggression, the FDA warned.

Pet overpopulation is a serious problem, and scientists have struggled to find ways to make animals infertile. Some were dangerous either for the animal or for the veterinarian administering them, said Bruce Addison, founder of Addison Biological Laboratory of Columbia, Missouri, which is selling Neutersol.

[end quoting]

One can only wonder what other agenda may really be driving this research and product. The usual neutering process for

pets has a longstanding track record of reliability and safety, and is a relatively cheap and painless procedure to perform.

MISS A PAYMENT AND YOUR CAR MAY DIE

From the *www.rumormillnews.com* website, 5/26/03: [quoting]

Imagine getting in your car and it won’t start. The situation would be aggravating for most, but for hundreds of thousands of Americans it could simply mean their car payment is overdue. A growing number of car dealers are using “starter stoppers” technology to ensure you don’t get lax on your loan.

Macy Pearson loves the used car she just bought, but it will only start if she’s made her car payment. Nestled under her dash is a device called a starter interrupt system. If Macy doesn’t pay, the device is set to disable her car so she can’t drive.

Macy’s salesman insisted she have it, since she has no credit history. Once Macy sends in her payment, she’s given a code number to input into a remote that connects to a device underneath the dash. “I stick it right in here. You punch in your code, you hear another little chirp, and you’re done” explains Macy, as she easily connects the device that will allow her car to run for another week.

Mike Simon’s company, Payment Protection Systems, made the device in Macy’s car and some 60,000 others bought at corner used-car lots and dealerships alike. He says the device protects dealers from credit risks. “The people know that they have to make their payment and they really do perform in making their payments on time” says Simon. “Our delinquency rate was probably up around ten to twenty percent without the device. And since then, it’s dropped down below two percent” says car dealer Steve Matthews about using the device with customers.

It may be good for dealers, but what about drivers? Not everyone’s sold on the idea of “no cash, no dash”. Jack Gillis of the Consumer Federation of America has written a book about buying a car. He says the devices could put customers at risk. “You might be in a situation where you are in an unsafe position, and you need to get out of there quickly, and you can’t do it” says Gillis about the pitfalls of such a device.

But device makers say cars won’t stop while in motion, they just won’t start once they’re turned off. Even then, drivers like Macy can call their salesmen for an emergency code that is good for 24 hours. Dealers also insist everyone is told about the service before they buy, and device

makers like Stan Schwarz says drivers are warned before the “kill”.

Manufacturers say the technology can make the difference between getting a car and walking on foot for many. But critics say customers don’t always leave the car lot with a better price, or better financing if they have the device. It turns out cars may not be the only things fitted with those kill chips. Look for them to turn up in computers, air conditioners, and yes, even TVs.

Macy’s no critic; she’s grateful for the opportunity to buy a car and working hard to get a solid credit history started. To her, that device under her dash is a dose of discipline. “It really helps because it makes you pay on time.”

[end quoting]

Do you get the feeling from this technological “advance” that perhaps Big Brother has arrived at a new level of surveillance and control over us? Next they’ll be wanting to put a lock on our wallet so we pay them first—or else!

FLUORIDE APOLOGY FROM PROMINENT RESEARCHER

From *The Tribune*, Mesa AZ, 12/5/99: [quoting]

Prominent Researcher Apologizes For Pushing Fluoride

by Barry Forbes

“Why’d you do it, Doc? Why’d you toss the fluoride folks overboard?”

I had just tracked down Dr. Hardy Limeback, B.Sc., Ph.D in Biochemistry, D.D.S., head of the Department of Preventive Dentistry for the University of Toronto, and president of the Canadian Association for Dental Research.

Dr. Limeback is Canada’s leading fluoride authority and, until recently, the country’s primary promoter of the controversial additive.

In a surprising newsmaker interview this past April, Dr. Limeback announced a dramatic change of heart: “Children under three should never use fluoridated toothpaste” he counseled. “Or drink fluoridated water. And baby formula must never be made up using Toronto tap water. Never.”

Why, I wondered? What could have caused such a powerful paradigm shift?

“It’s been building up for a couple of years” Limeback told me during a recent telephone interview.

“But certainly the crowning blow was the realization that we have been dumping contaminated fluoride into water reservoirs for half a century. The vast majority of all fluoride additives

come from Tampa Bay, Florida smokestack scrubbers. The additives are a toxic byproduct of the super-phosphate fertilizer industry."

"Tragically" he continued, "that means we're not just dumping toxic fluoride into our drinking water. We're also exposing innocent, unsuspecting people to deadly elements: lead, arsenic, and radium, all of them carcinogenic. Because of the cumulative properties of toxins, the detrimental effects on human health are catastrophic."

A recent study at the University of Toronto confirmed Dr. Limeback's worst fears. "Residents of cities that fluoridate have double the fluoride in their hip bones compared to the balance of the population. Worse, we discovered that fluoride is actually altering the basic architecture of human bones." Skeletal fluorosis is a debilitating condition that occurs when fluoride accumulates in bones, making them extremely weak and brittle.

The earliest symptoms? "Mottled and brittle teeth" Dr. Limeback told me. **"In Canada we are now spending more money treating dental fluorosis than we do treating cavities. That includes my own practice."**

One of the most obvious living experiments today, Dr. Limeback believes, is a proof-positive comparison between any two Canadian cities. **"Here in Toronto we've been fluoridating for 36 years. Yet Vancouver, which has never fluoridated, has a cavity rate lower than Toronto's."**

And, he pointed out, cavity rates are low all across the industrialized world, including Europe, which is 98% fluoride free.

Low because of improved standards of living, less refined sugar, regular dental checkups, flossing, and frequent brushing. Now less than 2 cavities per child Canada-wide, he said.

"I don't get it, Doc. Last month, the Centers for Disease Control (CDC) ran a puff piece all across America saying the stuff was better than sliced bread. What's the story?"

"Unfortunately" he replied, "the CDC is basing its position on data that is 50 years old, and questionable at best. Absolutely no one has done research on fluorosilicates, which is the junk they're dumping into the drinking water."

"On the other hand" he added, "the evidence against systemic fluoride in-take continues to pour in."

"But Doc, the dentists."

"I have absolutely no training in toxicity" he stated firmly. "Your well-intentioned dentist is simply following 50

years of misinformation from public health and the dental association. Me, too. Unfortunately, we were wrong."

Last week, Dr. Hardy Limeback addressed his faculty and students at the University of Toronto, Department of Dentistry. In a poignant, memorable meeting, he apologized to those gathered before him.

"Speaking as the head of preventive dentistry, I told them that I had unintentionally mislead my colleagues and my students. For the past 15 years, I had refused to study the toxicology information that is readily available to anyone. Poisoning our children was the furthest thing from my mind."

"The truth" he confessed to me, "was a bitter pill to swallow. But swallow it I did."

South of the border, the paradigm shift has yet to dawn. After half a century of delusion, the CDC, American Dental Association, and Public Health stubbornly and skillfully continue to manipulate public opinion in favor of fluoridation.

Meantime, study after study is delivering the death knell of the deadly toxin. Sure, fluoridation will be around for a long time yet, but ultimately its supporters need to ready the life rafts. The poisonous waters of doubt and confusion are bound to get choppy.

"Are lawsuits inevitable?" I asked the good doctor.

"Remember tobacco" was his short, succinct reply.

Welcome, Dr. Hardy Limeback, to the far side of the fluoride equation. **It's lonely over here, but in our society loneliness and truth frequently travel hand in hand.** Thank you for the undeniable courage of your convictions.

Want more scientific information about fluoride/fluoridation? Find it on the net: International Society for Fluoride Research (www.fluoride-journal.com).

"We have a duty to look after each

other. If we lose control of our government, then we lose our ability to dispense justice and human kindness. Our first priority today, then, is to defeat utterly those forces of greed and corruption that have come between us and our self-governance."

[end quoting]

The miracle is how this doctor's story ever made it into print, past the censors. Most inquiring minds (including some of us who were dentists) knew many years ago that fluorides are horrible poisons.

Notice this story is almost four years old and yet you haven't seen any changes in the official American policy toward fluoridated water. Could that have anything to do with the dumbing-down effect of fluoride (known since Nazi experimentation during World War II) to facilitate the control of the masses of we-the-sheep?

IS HIDDEN TRUE CAUSE OF ALZHEIMER'S YOUR TOOTHPASTE?

From the www.rense.com website, for 5/3/03: [quoting]

From Paul Kuhlman

Hello Jeff Rense,

I am a truck driver, and have hauled just about everything over the past 13 years.

I read your site's article postulating that naturally occurring aluminum found in water might be the key to Alzheimer's disease. I'll go one better than that.

I once picked up a 44,000 pound load of aluminum dioxide powder in the aptly-named town of Bauxite, Arkansas. Noting that the destination for the load was not a processing plant or a mill, I enquired as to why this load was destined for the Colgate-Palmolive Company. The shipping agent said that the quality of bauxite (aluminum dioxide) found in Arkansas was too low grade for manufacturing purposes, but was fine for toothpaste.

"Toothpaste?" I enquired. He then went



A HORSE IN BALANCE WEARS A CROWN OF LIGHT



A story honoring en-Light-ened riding masters who developed *Guidelines* to bring: discipline, beauty, grace, and balance in the movements of a horse, from a girl who desired to be a better rider. She became the first equestrian American woman in Olympic history. This is her own life story; how their *Guidelines* produced oneness with her horses, also the realization of Creator-God, the

Balancing Fulcrum, from riding the Figure 8. The en-Light-ened equestrian masters were Fritz Stecken and Ludwig Von Zeiner, Head Rider of The Spanish Riding School.

PRICE: \$12.00 (SHIPPING INCLUDED),
PAYABLE WITH NAME & ADDRESS TO:

M.B. Gill, P.O. Box 184 
Chester Springs, PA 19425

on to explain that common white toothpaste is made largely from aluminum dioxide, which is a mildly abrasive, brilliantly white powder. They'll simply add a sudsing agent to make the bubbles, a flavoring agent to make it palatable, perhaps a food coloring agent, some water, and presto—toothpaste.

Go read the ingredients on your tube of toothpaste. It'll list one or two "active ingredients"—notice the combined total amounts of "active ingredients" is usually less than 1%. What about the other 99%?

- Were you aware that every day of your life, you are filling your mouth with a gob of nearly pure aluminum dioxide?

- Can you imagine the possible health effects?

- Do you see how this is the number-one entry point for aluminum to enter the body?

- Can you guess why the inactive ingredients aren't listed?

- Imagine the outcry from all the millions of health-conscious Americans who suddenly discovered that they are being poisoned!

- Yes, that's why they aren't listed.

So, if you and your vast readership are concerned about getting too much aluminum in your diets, you can all relax about naturally occurring aluminum in the water, or cooking with pots and pans. These are trivial sources of aluminum compared with the several pounds of aluminum directly swallowed or absorbed through the tissues while brushing your teeth.

On the bright side, we can all still have a beautiful smile in our old age, if only we can remember how to smile.

[end quoting]

As a now-retired dentist, I learned long ago that you can't believe any labeling!

Furthermore, through their various well-paid puppets, the elite world controllers are quite skilled in feeding us the required poisons to advance their depopulation agenda—all the while filling their wallets from various poison-induced illnesses we get along the way to our death.

ANALYST STEWART SWERDLOW'S NEWS BRIEFS AND COMMENTS

From the *stewartswerdlow.com* website: [quoting]

In this regularly updated column, Stewart discusses current events based upon his personal knowledge and experience of Illuminati plans for the Earth.

To The Emerald City (5/7/03)

As you all have heard in the past few days, there were over 90 tornadoes touching down in the Midwestern and

Southern United States. Some of them were categorized as F4 and possibly F5 on the Fujita Scale. The town of Pierce City, Missouri was completely destroyed. The May 6, 2003 edition of the *Chicago Tribune* reports that there are 13 people still missing in the (13)0-year-old town. I am familiar with this town having passed through it several times on the way to visit relatives. This little town of 1400 people looked like something out of the 1950s. The word "pierce" in programming vernacular means to "cut through to another level".

These tornadoes that killed at least 40 people were artificially generated and were part of the same ELF pulses that created the earthquakes last week in Alabama and Arkansas. Tornadoes occurred on May 5, 2003 which numerologically equals 5-5-5. This is an activation of triplet programming and was part of an Illuminati national ceremony. Tornadoes within a programming matrix are created mentally by the internal programmer to switch alters from one level of programming to another. This is standard imprinting and conditioning. Local residents and meteorologists from Nebraska to Georgia said that they had never seen such devastation over such a wide area due to tornadoes. We must watch what happens in the next few days in the United States that would have required the need for such a ceremonial event. This type of activity is most likely going to trigger programmed slaves with Wizard of Oz programming.

Was Jessica Lynched? (5/11/03)

Former U.S. POW Jessica Lynch, age 20, who was rescued from an Iraqi hospital as the sole survivor of her unit, has amnesia. She cannot remember anything from the moment her vehicle was attacked until the moment of her rescue. How odd? (Convenient!) Doctors at Walter Reed Army Medical Center (and programming center) said she may never recover her memory (especially since they wiped it clean). All of her unit members died and were found buried outside the hospital. There has been no information about the condition of those bodies. Only her handlers know what type of heinous ritual she was used in and for what purposes.

It will be interesting to see what Utah's Elizabeth Smart remembers or forgets when her time comes to testify.

Grow This! (5/15/03)

The U.S. Agriculture Department is proposing a new rule that would require farmers to prove that their product is American-grown. This means paperwork detailing the life history of every pig, cow, sheep, etc. The cost and logistics of this documentation will put the small

producer out of business since they are responsible for paying for this and maintaining detailed records. Eventually, only large, government-sponsored farms and ranches will be left viable. Their products will all be genetically re-engineered and under strict government control.

If I Only Had A Brain (5/15/03)

From 1970 to 1999, the brains of at least 20,000 people were removed without permission in Britain by medical personnel and morticians. A report by Her Majesty's Inspector of Anatomy said that these were used for neuropsychiatric research (or possible cannibalism at rituals). Many more could have been destroyed or taken elsewhere. There were also more than 3500 organs from babies and children taken without permission by the Royal Liverpool Children's Hospital. In the U.S., the FDA is delaying regulation on transplant tissue that might be infecting and contaminating patients. Perhaps they were tired of sending Igor out to the cemetery with a shovel in the middle of the night.

A Naughty In Saudi (5/15/03)

The recent attack on the foreign compound in Riyadh has already been blamed on Al Qaeda, without ever sifting through the rubble. Guaranteed that the evidence will point to another Islamic country hosting the terrorists. Perhaps they shall accuse Iran, Syria, or Libya. We also have to eliminate the former Soviet Republics that are Islamic and bordering on China. These staged terrorist attacks are designed to rile up American support for destroying all countries where the populations wear robes and pray to Mecca. Saudi Arabia will eventually have a change in government and become extremely westernized as an example to others. The Royal Family of Saudi Arabia, set up by the British Monarchy in the 1920s, is on its way out.

The Blair Witch Hunt (5/15/03)

New York Times journalist, Jayson Blair, has been accused of embellishing and making up stories for his news reports. Blair, a Black man, is said to be a scandalous reporter who included fabrications in his articles. Remember a while ago I wrote about journalists being fired or killed for what they were writing, especially concerning the war in Iraq and the Elizabeth Smart case in Utah. Journalism is no longer about the truth. Perhaps it never was. Today, the news is a media variety show, designed to entertain and entrain the population to New World Order-sanctioned propaganda and disinformation. Hitler would be proud.

Weird News—Really! (5/17/03)

I have seen on the news that now there

is possible evidence that Laci Peterson was murdered by a Satanic cult who cut the fetus out of her during a ritual ceremony. I reported this back in December, 2002, when she disappeared from her California home. If proven, her husband will be vindicated of her murder and the police will have a lot of 'splainin' to do!

Also, I have been receiving reports about that missing Los Angeles film crew in Antarctica. They disappeared in November, 2002. Now, apparently their film has been discovered 100 miles west of Lake Vostok (check the archives for an earlier story on this). The film supposedly contains scenes of a large excavation by the U.S. government two miles below the ice which revealed an ancient city with amazing architecture, technology, and glyphs on the walls. The U.S. government has censored release of this film, citing national security risks. (Perhaps this is where Saddam and Bin Laden are hiding—or perhaps it's Superman's frozen hideout.) I am attempting to verify this story, which is reported to have other strange connections to a Lovecraft novel from the 1930s. The film crew is still missing.

I am researching the news story of the woman who killed two of her sons by bashing them in the head with a rock because God told her to do it (shades of the Houston drownings). Her one-year-old still clings to life. Hearing voices like that is a sure sign of programming triggers.

Finally, a military attack in Iraq this week by American troops was called "Operation: Planet X". This is a clear reference to Nibiru/Marduk and a staged alien invasion. As details of the above stories emerge, I will tap my sources for the story behind the media story.

Yellowknife Strife (5/20/03)

The son of Canadian Prime Minister Chretien was acquitted of sexually assaulting a 19-year-old woman in Yellowknife, Northwest Territories. The woman said Michel Chretien, 34, assaulted her three times when she was 10 or 11 years old. The active Michel was sentenced to three years in prison in 1992 for sexually assaulting a woman. In 1998 he received a nine-month suspended sentence for assaulting his girlfriend's six-year-old son. Well, he certainly sounds like U.S. Presidential material.

The Imprinting Update (5/20/03)

The following is a small list of current Illuminati imprinting on the public concerning mind-control, ritual, and sacrifice:

- The release of the movie sequel *Matrix Reloaded* and its implication of

KIND WORDS FROM OUR READERS

"Dear Ed: I am in profound appreciation for the great work that you and your team of Lightworkers are doing to help the American people wake up now that the American Dream has turned into the American Nightmare.

"Blessings on your path."

— **Dr. A.J. from CA**

"Dear *SPECTRUM*: I found your article in your June 2003 issue on 'Looting Iraq Of Priceless Weapons Of Mass Destruction' very interesting.... Your articles always make me think about what is going on—very inspiring. Thanks, and keep up the good work you all are doing. It is much appreciated."

— **M.G. from OK**

"Dear Friends: I'm always grateful to you for the information each month. I read it all! It seems that much more is about to happen for us. Have our water, food, batteries, etc., updated and doing the best that we can."

— **V.B. from WV**

"To all at *The SPECTRUM*: Health and Happiness! With Love and Light! Don't know how you do it. You must work 36 hours a day." — **H.M. from AZ**

[*Editor's note: That's the only drawback once we perfected the time machine. Now there's no excuse not to work 36 hours a day—or so it seems!*]

"I've been reading *The SPECTRUM* for the last 2-3 years, and I have always thought it was great. But in the last year, you have really reached a new level."

— **N.P. from NY**

"Dear *SPECTRUM*: I want to thank every one of you who work so hard to get each month's issue out. I pray for you all. I really look forward to each issue. Light and Love to you all."

— **D.F. from MO**

"There are many interviews, talks, and classroom lectures that I have given over the years, but sometimes things just flow and new bits of information come out that I never included anywhere before. Rick Martin and I had been talking about this interview for some time and then one day he called me and turned on the recorder and we let it roll. The following interview is 'A#1 primo' and a credit to Rick Martin who guided the path for you to see the past, present, and future."

— **astrophysicist James M. McCanney**

(**excerpted from his website introduction to our May 2003 feature story**)

To order *The SPECTRUM* please call: 1-877-280-2866,
or if you are outside the U.S. please call: 1-661-823-9696.

holographic reality mind-control.

- Serial killer on the loose in Southern Louisiana who defies capture. The police have basically told women that they cannot protect them. Perhaps the police know who he is but are protecting him.

- The hazing incident in the Chicago area high school where the pledges were videoed being beaten, abused with paint and garbage, and verbally humiliated.

- The constant appearances of white rabbits on American television commercials.

- Virtual grass is being promoted in the Southwestern U.S. This new form of Astroturf which turns the desert to green is another method of encouraging artificial environments which subliminally support

programming matrices.

I've Seen Fire & I've Seen Rain (5/20/03)

A volcano in the Northern Mariana Islands, previously thought to be dormant, erupted last week, causing an evacuation of the tiny island of Anatahan. There has not been a significant eruption in this island chain since 1981. The seismic equipment set up there years ago is no longer functioning since funding has run out. The eruption brings to light the dangers of volcanic activity in the Pacific. Recently, new fault lines were discovered under Hawaii, and a moving plume of magma was pushing toward the Big Island. There has also recently been a swarm of small quakes near Mt. Rainier in Washington State.

THE BAY AREA CONSCIOUSNESS NETWORK PRESENTS:

NEW!

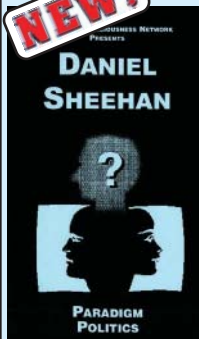

PARADIGM POLITICS by Daniel Sheehan

**VHS
VIDEOS**

Daniel Sheehan is a social activist who has spent virtually his entire life working on progressive social programs and initiatives. As the Legal Counsel on such nationally-recognized investigative cases involving government as the Karen Silkwood Case, the Iran/Contra Case, the Pentagon Papers Case, the Watergate Burglary Case, and the American Sanctuary Movement Case, Dan brings to the issue of Extraterrestrial Intelligence and the UFO Phenomenon a unique background in investigating and exposing the world of American governmental covert operations, "black budget" operations, mind-control programs, government disinformation projects, covert warfare, and clandestine operations. He established the Christic Institute

in Washington DC, which for nearly two decades was the country's preeminent public-interest law firm.

VHS video – 120 min.
\$19.95 (+S/H)
Code: PPV (1.0 lb.)

NEW!

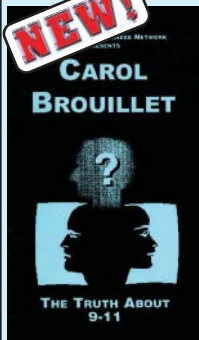

THE TRUTH ABOUT 9-11 by Carol Brouillet

Carol Brouillet is a Co-Founder of the International Media Project, which produces *Making Contact*, a half-hour radio program now heard on over 165 stations, primarily in the U.S. and Canada. (*Making Contact* will also pilot a new daily show beginning in February 2001.) Carol also helped found the Who's Counting Project, which promotes the film *Who's Counting? Marilyn Waring on Sex, Lies & Global Economics*. Both non-profits seek to connect people, vital ideas, and important information to nurture healthy social change, economic justice, and ecological sustainability. A passionate advocate of local currencies to raise consciousness, nurture community, and increase local self-reliance, her paper *Reinventing Money, Restoring The Earth, Reweaving The Web Of Life* has won an honorable mention from the Millennium Institute as one of the best ideas for the 21st Century.

The Earth, Reweaving The Web Of Life has won an honorable mention from the Millennium Institute as one of the best ideas for the 21st Century.

VHS video – 91 min.
\$19.95 (+S/H)
Code: 911V (1.0 lb.)

NEW!

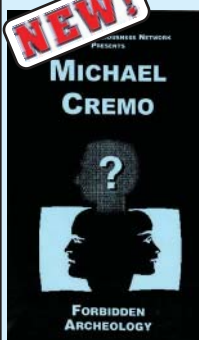

FORBIDDEN ARCHEOLOGY by Michael Cremo

Michael Cremo is on the cutting edge of science and culture issues. In the course of a few month's time he might be found on pilgrimage to sacred sites in India, appearing on a national television show, lecturing at a mainstream science conference, or speaking to an alternative science gathering. As he crosses disciplinary and cultural boundaries, he presents to his various audiences a compelling case for negotiating a new consensus on the nature of reality. Michael Cremo is a member of the History of Science Society, the World Archeological Congress, the Philosophy of Science Association, the European Association of Archaeologists, and associate member of the Bhaktivedanta Institute

specializing in history and philosophy of science.

VHS video – 120 min.
\$19.95 (+S/H)
Code: FAV (1.0 lb.)

NEW!



SCIENCE, POLITICS AND THE NEW MILLENNIUM by Dr. Nick Begich

Best selling author and lecturer Dr. Nick Begich presents an overview of the HAARP (High-Frequency Active Auroral Research Program) transmitter and antenna in Alaska. His countless years of research helps to provide a glimpse of new technological achievements that can help better the environment and reshape mankind in the future. Pulling from an array of extensive documentation from government, academic, and media sources, Begich is able to explain the big picture in terms that anyone can understand. There was a city-wide power loss shortly after Begich began his presentation, but through the use of a quickly placed battery pack, very little of this valuable presentation was lost.

VHS video – 120 min.
\$19.95 (+S/H)
Code: NBV (1.0 lb.)

Meanwhile, in Sri Lanka, flash floods and landslides have killed over 140 people, and more rain is on the way. The region hardest hit is the Ratnepura district famous for its gem mines.

Arrogant Ari—Gone (5/21/03)

White House Chief Spokesman Ari Fleischer, the bald-headed, snippy, anti-social voice of George W. Bush to the press, has decided to resign as of July, 2003. The official reason is that the pressure of the job is too much, and the 42-year-old wants to return to a quieter life in the New York suburbs with his wife of six months. Fleischer is known to reporters for his arrogant attitude, and often incorrect information. He is the latest in a string of Bush aides who have left the White House service in the last 18 months. Wonder what they found out?

Bandar Barter (5/21/03)

Prince Bandar bin Sultan, Saudi Arabia's Ambassador to the U.S. (and resident of Aspen, Colorado) warns that "something big" in the way of terrorist attacks may soon strike the U.S. and Saudi Arabia. Bandar, exposed by Cathy O'Brien in her book, *Trance-Formation Of America*, as a handler for Monarch sex-slaves, says he gleans this information from his "gut feeling". Well, that's hard evidence! How about he knows because he is part of the plan! Remember, fifteen of the hijackers on 9/11 were Saudis. Osama bin Laden is Saudi. The Saudis also refused to allow their country to be used by American forces against "their brother, Iraq". Is this Prince to be trusted? What does he know that he hides behind those robes? There is a great deception here.

Pardon Me, Have You Seen My Tank? (5/21/03)

The Department of Defense has a problem. They cannot account for \$1 trillion (yes, that's trillion!) in cash! They also seem to have misplaced 56 airplanes, 32 tanks, 36 Javelin missile command launch-units, and a partridge in a pear tree. These are the same folks who spent \$640 on a toilet seat. Seems to me the cash and equipment went somewhere.

Oh, and Vice President Cheney is missing too! Perhaps they should look in those 131+ underground bases the public doesn't know about. Or, perhaps they might look at the secret terrorist programming centers that the New World Order has all over the world—none, by the way, in Afghanistan or Iraq. We, the American public, are not amused. We would like our money back—and not be persecuted for asking! People are afraid to say anything these days for fear of being placed on a list of "suspected terrorists" or being a "person of interest". What has

SEE NEXT-TO-LAST PAGE FOR ORDERING OR CALL TOLL-FREE: 1-877-280-2866

happened to America? We should not be looking in Central Asia. We should look along the Potomac!

Body-Mania (5/23/03)

- United Kingdom: Archeologists have unearthed six bodies near Stonehenge that date from 2300 B.C. At least some evidence points to the fact that they originated in Switzerland.

- Arizona: Three mummified infant bodies were found in a warehouse. They were stored by a woman from New York who apparently gave birth to three babies from 1981 to 1984. When they died, she kept their bodies in storage.

- Congo: Government and military personnel are hunting and killing pygmies to eat. They claim their flesh has magical powers.

Another One Bites The Dust (5/23/03)

Former New Jersey Governor Christie Whitman, EPA Administrator, just resigned from the Bush Cabinet, adding to the growing list of those who are fleeing the Bush Government. Whitman, from the most polluted state in the U.S.A., was a poor choice to head an Environmental Protection Agency. She and President Bush allowed more arsenic in the drinking water and more oil drilling in pristine areas. To her: good riddance! No loss! However, she claims she wants to spend more time with her family. All of them have said this. What do they know is coming? By the way, Prime Minister Blair of the United Kingdom had his spokesperson recently resign.

G8 Not GR8 (5/23/03)

Next week, this year's G8 meeting will be held in France. Bush will argue for the acceptance of genetically-altered food to Europe and Africa, whose countries are reluctant to accept them. Bush will also push for \$15 billion over the next five years to combat AIDS in Africa and the Caribbean. He said: "I will remind them that the clock is ticking." Yes, it is a countdown to their deaths. As usual, the global public will not be informed about what these self-righteous men have planned for them.

Alter-Nate Reporting (5/23/03)

Former *New York Times* reporter Jayson Blair said he often laughed at his deceptive stories in the newspapers. He was gleeful over fooling the "most brilliant people in journalism". It is reported that Blair had serious mental issues. In an interview he states: "I was either going to kill myself or I was going to kill the journalist persona. So Jayson Blair the human being could live, Jayson Blair the journalist had to die." Those readers who have seen my mind-control and programming videos know that this is the statement of a person trying to

deprogram by eliminating a front alter in his programming matrix.

Mad Cow, Eh? (5/23/03)

It has been determined that a cow in Alberta, Canada that was slaughtered last January(!) has Mad Cow Disease. It took until May(!) for the test results to return. Talk about a quick turnaround! Seems like someone in the New World Order wants to punish Canada. First SARS, now Mad Cow. Many countries now ban beef imports from Canada even though this animal died five months ago and nothing has turned up since. The fallout has caused stocks in food retailers to drop. Stand on guard, Oh Canada!

Quake Report (5/23/03)

Algeria is the latest target of temblor activity. A M6.7 quake rocked this North African country, killing well over 1,000 people. Following a reverse trend, quakes are moving east to west this month. Starting with China, then Afghanistan, Turkey, now Algeria. Next in line is the Mid-Atlantic Range (undersea) followed by Southeastern U.S. (Charleston area), then Missouri, California, and Hawaii.

Halliburton Halibut (5/26/03)

A recent article in the *New York Times* titled "Dancing With The Devil" was a fascinating comparison of how the public, guided by the media, attacked the Dixie Chicks for speaking their minds, while Vice President Cheney and his "meal ticket" the Halliburton Company remain unscathed. Since 1984, Halliburton has made moneymaking deals with Libya, Iraq, and Iran, three nations on Bush's "axis of evil" list. Yet, Cheney, from 1995-2000, while head of Halliburton, continued these deals.

In fact, in 2000, Halliburton opened an office in Teheran, Iran. Interestingly, they also now stand to make \$billions running Iraq's oil production operations. So, why aren't people saying anything about this? Only Congressman Henry Waxman of California has raised these issues with Defense Secretary Donald Rumsfeld—old bathroom face.

The New York Times article refers to Halliburton as "a slithering enterprise with its rapacious tentacles in everybody's pockets". A clearly Reptilian description. Looks like a Congressman and another *New York Times* writer are going to bite it!

9/11 Holdovers (5/26/03)

After 9/11, men from Muslim countries were ordered to register with the U.S. government. About 13,000 Arabs and Muslims have been detained without legal representation and could be prosecuted and/or deported. These men have American families who are now not supported financially. Phone calls from the detention centers cost \$2 per minute.

These men registered to comply with American law, and now they are being persecuted as are their families. Reminds one of another country back in the 1930s and 1940s.

Don't Do It! (5/29/03)

For the past two years, I have warned Black Americans not to register with the government. The ploy has been to determine connections to slavery for possible reparations. Then it was to pay them for DNA samples to determine connections to White ancestry from slave owners. Since none of that worked, they are saying it is to help collect data for Black race diseases since Blacks are "left out" of health studies and healthcare. None of this is true. They want Black DNA to determine who should be eliminated and who is "salvageable" for programming. The last people to do this were the Nazis. The Jews in Germany who registered are now gone from the Earth. Please, all Black readers—do not do this!

California Swarmin' (5/29/03)

This past weekend saw another swarm of quakes in and around the San Francisco area. There was only minor damage and some gas leaks. However, this is connected to the upwelling of magma under the Pacific Northwest. Mt. Rainier has been evacuated in Washington State and scientists are examining data from equipment there after a swarm of quakes around that mountain. I am headed to the region at the end of July and August. Stay tuned as I receive more information. Residents from San Jose to Seattle—take precautions!

Fire & Water—Again! (5/29/03)

Two very strange stories evolve this month. A crewman on the USS Nassau fell overboard while trying to catch a football on deck. This occurred about 900 miles east of the Virginia coast. Then, the next day, another sailor missed role call and is presumed fallen off the ship, in the middle of the ocean! Very odd that two crewmen disappear within days of each other from the same ship!

Meanwhile, both Texas and Alaska are under clouds of smoke from fires in other countries. Mexico farmers are burning off old crop material and the haze and smoke are choking residents of Central and South Texas. In Alaska, smoke and haze from fires in Russia are preventing sunlight from reaching the ground. What is going on in the skies of Texas and Alaska that the public should not see?

Youth Core? (5/29/03)

The Department of Labor is bringing child soldiers from Sierra Leone to speak in the public schools about their forced servitude in their homelands. They describe everything from graphic death

scenes to rape. Do our young children really need to hear these atrocities in such detail? Once the plight of these soldier/children is publicized and society primed, they will be brought to the U.S. and “integrated” here with our own youth. (I wonder who will influence who?) These children are already traumatized and jaded, out of necessity for self-survival—perfect mind-control candidates.

Additionally, more power is being granted to our children—16-year-olds being allowed to vote because a law was passed “inadvertently” (this is already being discussed in the United Kingdom as a way to increase voter turnout—yeah, right!), school prayer as long as the children instigate it, children soldiers in our society. Sounds like the “youth core” of Communist China days when the children were turning in their parents and friends. Watch for this trend to continue.

The Kids Seem Rather Bright In School (6/1/03)

The U.S. Department of Agriculture (USDA) has lifted its ban on irradiated beef for school lunch programs. This opens the way for the 27 million students in the U.S. on the lunch program to eat irradiated meat, I suppose after they have been on the Ritalin line. The USDA is on its way to becoming the largest supplier of irradiated beef in the world. They light up your life.

[end quoting]

Once again Stewart’s keen eye catches events of behind-the-scenes significance that we might otherwise miss.

HERE’S THE HANG-UP: AT&T SAYS “YES SCAM” VICTIMS OWE FOR CALLS

From the www.rumormillnews.com website, 5/29/03: [quoting]

When Susan Steel called her phone line a few months ago, she heard something strange.

Instead of her usual voice-mail greeting, a man with an accent answered: “Investment office, please hold.” Then after a burst of elevator music, the voice returned to say: “Yes...yes...yes.” Steel kept saying “hello”, but the man ignored her, then hung up.

It wasn’t until the next day that Steel, a self-employed employee recruiter in San Francisco, learned what had happened: She was the victim of the “yes scam”.

Someone had hijacked her voice-mail box to make thousands of dollars in long-distance phone calls to Saudi Arabia and the Philippines.

Here’s how the scheme works:

In recent months, hackers have been dialing into peoples’ voice-mail boxes and trying to guess the password. If

successful, they then record a new outgoing message. Later on, the hacker places a long-distance phone call and asks the operator (or a computer) to forward the charges. The operator calls the hacked phone number and gets the changed message, which tricks the phone company into thinking the line’s owner has agreed to accept the charges for a long-distance phone call.

In Steel’s case, before she had a chance to change her phone message, the hackers had run up more than \$20,000 in long-distance charges via AT&T, including 95 hours in overseas calls.

But even though AT&T agreed Steel was the victim of fraud, it insists she’s on the hook for much of the charges.

“It is an awful thing” Steel said. “I can’t sleep. I wake up and think about it.”

Steel is hardly alone. Phone thieves have reportedly broken into the voice-mail systems of scores of victims nationwide, sticking them with thousands of dollars in overseas phone charges before they detect anything amiss.

Experts said AT&T is one of several companies affected by the scam. But while SBC Communications and other companies have agreed to reverse the charges, critics complain AT&T is insisting customers pay for thousands of dollars in calls they never made.

AT&T blamed the customers for using easy-to-guess passwords or never bothering to change the default passwords assigned by their local phone company. (Steel, who never worried about anyone tapping into her voice-mail box, used the easy-to-remember code 1-2-3-4.)

“The customer is responsible” said AT&T spokesman H. Gordon Diamond. Also, Diamond faulted SBC for not doing enough to warn customers to change their voice-mail codes.

But SBC blamed AT&T’s automated system, which asked the same question exactly the same way, making it easy to fool with a recorded message.

In Steel’s case, Diamond said, a human operator was fooled by the message.

Diamond said the phone company has taken several measures to trip up the scam in the future. For instance, the company sometimes asks recipients of a collect call to punch in a random number on their key pad to make sure it’s a real person authorizing the call, and not a sophisticated voice-mail recording.

Since it added the security measures earlier this year, Diamond said the company has recorded only a handful of voice-mail fraud cases.

But SBC spokesman John Britton faulted AT&T for continuing to press victims of the scam to pay for the fraudulent calls. [end quoting]

Be aware of this scam and pass this information along to friends and relatives. Also note the arrogance of the AT&T position on this matter; keep it in mind when you see their folksy advertisements (and get annoying dinnertime calls) to switch your phone service to AT&T.

PRINT ME A PANCREAS, PLEASE

From *Popular Science* magazine, for May 2003: [quoting]

Desktop printers assemble three-dimensional living tissue. Are replacement organs next?

Seeking a better nose? Plastic surgeons might someday be able to print you a new one right on their PCs. A team of scientists has used an off-the-shelf ink-jet printer to assemble three-dimensional living tissue, a breakthrough that could pave the way for mass-produced transplant organs and made-to-order body parts.

Today’s tissue engineers work mostly by hand, dipping a polymer scaffold into a bath of cells and nutrients. This is a time-consuming technique that works fine for small scraps of tissue or hollow organs like the bladder, but not for livers or kidneys, says Thomas Boland, a chemical engineer at Clemson University, who developed the technique with Vladimir Mironov from the Medical University of South Carolina.

Large organs contain millions of cells, all fed by a complex web of tiny blood vessels. Engineers cannot currently construct these vascular supply lines fast enough, so interior cells starve to death before the organ can be completely built and its cells fused.

Enter ink-jet printers. Inspired by industrial rapid-prototyping machines that squirt out plastic car fenders and doll arms, the research team wondered if they could use similar printers to slather cells right where they needed them, building complex organs one layer at a time.

“You say to yourself, ‘Wow, why didn’t I think of that?’” says Anthony Atala, a leading tissue engineer at Harvard Medical School.

The team scrounged Hewlett-Packard and Canon ink-jet printers from university surplus, swapped hamster ovary cells for ink, and made a few hardware tweaks. In place of paper, the scientists print the cells on a stationary sheet of temperature-sensitive biodegradable gel that holds the cells in place until they fuse. Once the

cells have set, they simply adjust the temperature of the tissue slightly until the gel melts away.

The scientists haven't made anything fancy yet, just a bagel-like ring of hamster ovary cells to show the idea works. "By the end of the year, we hope to make a decent blood vessel" says Boland, who described his work in the April issue of *Trends In Biotechnology*.

Printing a new liver or kidney is still a long way off, the scientists emphasize. More likely the technology will first be used to create custom tissue scraps for drug screening.

But one near-term possibility is to create spare parts for plastic surgery. Cartilage, says Mironov, contains few blood vessels, so it is easier to make. (Companies already grow replacement knee cartilage.) A few years ago scientists even sculpted a crude human ear. A tissue printer, says Mironov, could speed the process and make it far more precise. "Let's say I want to have a nose exactly like Clint Eastwood" he muses. A surgeon could fill an ink cartridge with cartilage cells, download the blueprint, and tap print: "You have a new nose in five minutes." — Michael Stroh

[end quoting]

It's a big step from what has currently been demonstrated as possible to what they quickly jump to as "just around the corner"—like the promise of a cure for the common cold for fifty years now.

NANO SPACE:

THE NEW SPACE RACE IS THE BATTLE FOR MORE AND MORE CONTROL OVER LESS AND LESS

From *WIRED* magazine, June 2003:
[quoting]

MICROCOSMOS — by Larry Smarr

I have seen the future, and it is small. Steady advances in miniaturization are leading technologists beyond the scale where Newton's laws govern the world and into the realm I term the nano arena. Within the unimaginably tiny space of 100 by 100 nanometers—one millionth the area of the period at the end of this sentence—we're about to witness an amazing collision of physics, biology, and information technology. Developments in nano space will define this century just as electronics defined the last.

Outside the arena, electrons behave like billiard balls. Squeeze them into narrower confines, though, and they behave like waves rather than particles, and counterintuitive quantum phenomena like tunneling, spin, and entanglement take effect. In conventional devices such

as microprocessors, this is a problem; electrons won't stay on their copper paths, spontaneously disappearing and reappearing elsewhere. But some engineers now realize that if they design with quantum effects in mind, they can build incredibly small electronic devices. And if scientists can manipulate individual light quanta within the arena—a field known as nanophotonics—these devices can communicate.

Consider IBM's quantum corral, an elliptical arrangement of iron atoms on a copper base 14 nm across. The corral, invented in 1993, could conceivably store information by holding atoms that signify 1s and 0s.

IBM's minuscule invention is only a little smaller than a more common information-bearing nanostructure: rhinovirus, the cause of the common cold. Rhinovirus' 20-sided shell of interlocking proteins protects an RNA strand of roughly 7,000 nucleotides. That is, this replicating nanomachine essentially carries 7 Kbytes of executable code.

The quantum corral stores data. Rhinovirus executes a program. Design a nanophotonic interface between them and, in principle, you've got a computer only 100 times bigger than a silicon atom!

Today, the corral is considered an engineered device, while rhinovirus is viewed as a biological entity. Within the nano arena, though, the distinction is meaningless. Both are nanomachines, one built on a substrate of metal, the other on a substrate of organic molecules. Bridging the gap will spark an explosion of playful development as nanoscale devices are snapped together as if they were Lego blocks.

At first, technologists will replicate familiar devices like motors and switches, but soon they'll set out in entirely new directions. Nanocomputers will be cheap and plentiful, making it possible to embed the world with intelligence. Everything will have information-processing capability—every brick, bicycle, and body.

Scientists and engineers who come of age working in the nano arena won't cloister themselves in disciplinary guilds. They'll be equally adept with the tools of the bio lab, the chip fab, and the physics department. They'll be masters of bioinfonotech.

[end quoting]

You can be sure that the military is already far down this road. It brings up the argument that our technology is far outpacing our morality—and a wreck of major proportions may be just around the bend.

COOL USE FOR MAGNETS

From *Popular Mechanics* magazine, June 2003: [quoting]

Mindful that Japan imports all of its fuel, Nagoya-based Chubu Electric Power has found a way to cut the electricity needed for refrigeration. At a recent meeting of the American Physical Society in Austin, Texas, Chubu described a refrigerator that uses one-third less energy. Instead of using an electric motor to compress a working fluid to carry away heat, a rotating permanent magnet compresses and relaxes a magnetic field. Chubu plans to sell a household model. [end quoting]

Considering how popular refrigerators are, with at least one in every household, this could put a big dent in the Japanese electric bill. Hopefully this company will be smart in their exporting of the technology to countries where, like the 100-miles-per-gallon carburetor, such practical increases in efficiency are squashed by Big Business greed.

NATURALLY FORMING ARTWORK

From *Popular Mechanics* magazine, June 2003: [quoting]

Images resembling American Indian art appeared when a magnetic field was applied to metal particles in a liquid. Massachusetts Institute of Technology senior Cory Lorenz wanted to see if the particles could form structures. Instead,

CLASSIFIED ADS

Solutions to Your Ultimate Health Concerns. Addresses the cause of all illness utilizing an "Electrical Understanding". Eliminate chronic & degenerative diseases. Attain high energy and youthfulness. **Transform your life forever.** Free info package. Call NOW! **1(888)658-8859** E-mail: **louish3@shaw.ca**

Cooking for PEACE. A booklet of various recipes, special foods, beverages, to help balance the immune system, electrolyte levels, and important cellular growth. Price: \$12. Send name and address to:

Cooking for PEACE

P.O. Box 184, Chester Springs, PA 19425

How wonderful is the brain to alert an unbalanced part of the body and the mind
TO SEEK THE TRUTH.

patterns emerged. "It was the first time this had ever been observed" says Lorenz's adviser, Markus Zahn.

[end quoting]

Perhaps this discovery will lead to a new field of art or imaging technique.

MOLDING MOLECULES WITH LIGHT

From *Popular Mechanics* magazine, June 2003: [quoting]

Researchers have found the key to creating a real "Star Trek"-style Holodeck. Holograms have, of course, been around for decades. While your hand passes unimpeded through a hologram's ghostly images, microscopic particles can be drawn to regions where the light is brightest.

At a recent meeting of the American Physical Society in Austin, Texas, researchers explained how this particle-drawing effect has been used to create holographic optical "tweezers" that suspend particles in space. University of Chicago physicist David Grier, who pioneered the technology, said very large computer-generated 3-D holographic arrays could create bright spots or optical traps that exert sufficient force to suspend a collection of microscopic objects. "This is StarTrek's Holodeck in action" he said. The first application will be more serious: building smaller and faster "lab on a chip" chemical analyzers. [end quoting]

Does this mean we'll one day be watching *Star Trek* reruns on a virtual TV formed purely from light?

BLUE LIGHT SPECIAL

From *Popular Science* magazine, for June 2003: [quoting]

A novel way to squeeze more data onto CDs and DVDs.

Sony's high-capacity blue laser DVD recorder, set to debut in the United States this fall, crams five times more information on a disc than the standard red laser version does and heralds the arrival of next-generation technology. Enthusiasts eager to get their hands on that much data capacity, however, may think twice after learning that production snags boosted the DVD's price to about \$3,500. But researchers at BlackLight Power in Cranbury, New Jersey, say they have made a discovery that may help overcome technical hurdles and get reliable blue lasers to market.

When the kinks are worked out, blue lasers will likely be the heart of next-generation DVDs, CDs, printers, and scanners. Having shorter wavelengths than their red brethren, they can etch more

data on a disc. It's the optical equivalent of taking a sharper pencil to paper. But manufacturing flaws have plagued the emerging technology.

The standard way to generate blue laser light is to run an electric current through a crystal or chemical. Excited electrons in the substrate then emit blue light rays. Trouble is, the substrates tend to crack under extreme heat, a glitch that ruins up to a third of all batches. And the solutions are pricey.

Liquids, however, don't crack. Enter the world's first water-based blue laser. Researchers at BlackLight Power heated water vapor with microwaves to generate energized hydrogen atoms which emit multispectrum light rays, including infrared, blue, and violet. A prototype blue laser device is expected by the end of the year.

The team says such a multispectrum laser light could be miniaturized to micron dimensions for many microelectronic applications. "A hydrogen laser may prove to be the most useful of all" says Randell Mills, BlackLight Power's CEO.

— Charles Q. Choi

[end quoting]

Don't hold your breath on the liquid approach to solving this problem in an affordable manner. Also don't be in a big hurry to buy the new blue laser products unless you're willing to be among the statistics where the blue lasers failed downstream after you're using the product for a few months. It sounds like they have some serious bugs to work out yet before this is reliable technology—par for the course, at the public's expense, when rushing things to market.

INTERESTING SEARCH TOOL

From researcher Calvin Burgin (wrlldline@texas.net), for 5/29/03:

[quoting]

Al, in case you don't know, if you use Google to search you can type in a phone number in XXX-XXX-XXXX format (include the hyphens), and click search, and it will give you the name and address, sometimes a map, of the person and sometimes other information.

A friend tried his phone number and it showed his name and address and an accident report of when he crashed a plane as a student pilot in World War II.

[end quoting]

After a little testing, it was found that this identification method worked for listed telephone numbers, but DID NOT WORK for unlisted numbers. Again, do you get the feeling that Big Brother is REALLY watching us?!

HOW TO GET BETTER RESULTS USING GOOGLE SEARCH ON THE INTERNET

From *Lockergnome Windows Daily* (lockergnome.com) 5/03: [quoting]

Normally I have to scour the forums to bring you great little tidbits to share with you, but a little birdie gave this one to me—and it is just too good to pass up! So I'm gonna step aside, and let Oftentired take the command today:

A successful search using Google can be an interesting experience. The key is to use the best possible keywords for the search and to use as few keywords as possible. After you have your initial Google results, if you are lucky or have used these keywords before and know they work, you will find what you're looking for on the first Google page of results.

If you cannot find what you're looking for on the first (or only) page of results, there are three choices to consider:

1. Use different, or additional, or fewer keywords for a new search: If your search results appear to have too many different topics of information, remove one or more of the keywords from your search that relate to the more obvious results that you didn't want—even if those keywords seem essential to your search. If you have more keywords that you didn't use for the first search because you wanted to keep it simple, now would be a good time to use them either for a new search or in place of some keywords you removed. Sometimes your second or third choice of keywords is the right one. At the bottom of a Google results page is a link to "search within results". Sometimes you can narrow your search down using better keywords that may come to mind after you view the first search results. Just click the link and type in your keywords. No need to repeat the ones you already used.

2. If there is more than one Google page of results, try clicking the second and then third page and see if you get lucky. Do not waste much time doing this. The odds are greatly diminished if you don't find it on the first couple of pages.

3. Right-click links (see Hint #3 below) that don't have exactly what you're looking for, but which DO display words that appear to have something similar to what you're searching for, and open them in a new window. Quite often, you will find a link to what you're looking for on one of these pages. Just as often, you will discover better keywords to search for on one of these pages. Almost as often, you will get lost for an hour looking at really interesting stuff you were not originally looking for.

Hint #1: This one is a no-brainer, and you will kick yourself every time you realize you didn't do it: use a keyword that will obviously always be on the page of information you are looking for. This keyword will have absolutely nothing to do with what you are looking for. Example: If you are searching for a program to download called "cars" and perform a search for "cars", you will get a whole bunch of cars. Red cars, green cars, blue cars, new cars, used cars, 1998 cars, 2000 cars, etc.... Now, change your search and use the keywords "cars download" and see what you get. Downloads, all kinds of them, and there is a game called Tiny Cars that you can download. How about that?

"Hint #2a: If you have something you're looking for that has more than one word to describe it, and those words are in the shape of a phrase, try searching with quotes around your phrase with no other keywords present. You may get lucky. For example, if I'm searching for information on my Samsung CDRW, I can get the exact name of it from my system information and search using that exact name. But, I will get search results containing all of the words scattered around, and not just together as they would be if the page had specific information on it regarding my particular make/model. What I'm looking for WILL be in the search results, but I will have to spend an hour clicking page 2, 3, 4, 5, 6, 7, etc., to find it. In most cases where there is a page of detailed information, it will also have the exact title of what you are looking for. If I put the quotation marks around the title of it, I will be more likely to get the results on my first or second page of search results.

Hint #2b: The use of quotation marks also applies to error messages. But searching for error messages needs a separate hint. Sometimes taking chunks of a long error message and searching for parts of it that seem to be most specific to the error can provide quick results.

Here's an example of how I would do a Google search for this error message: "The error CMDNINST caused a general protection fault in module KRNL386.EXE at 001:00002867"

1. Try the entire thing first without quotation marks (The error CMDNINST caused a general protection fault in module KRNL386.EXE at 001:00002867)

2. Try the entire thing enclosed in quotes ("The error CMDNINST caused a general protection fault in module KRNL386.EXE at 001:00002867")

3. Try the entire thing with some words removed; no quotes. (error CMDNINST caused general protection fault module

KRNL386.EXE 001:00002867) or (CMDNINST caused protection fault module KRNL386.EXE)

4. Try different, completely intact sections of it in quotes ("CMDNINST caused a general protection fault") ("fault in module KRNL386.EXE") ("module KRNL386.EXE at 001:00002867")

5. Try the idiot numbers that showed up, with and without quotation marks. You might get lucky and find yourself hollering BINGO really loud. (001:00002867 or "001:00002867")

Hint #3: Always right-click and Open in New Window every link you look at from your search results. This will save you a lot of time. To go back to your search results, just minimize the new window or click the X to close it. But do remember to keep the link window open if there is even the remotest chance you will want to look at it again. By keeping the original search results open in their own pristine window, you will save a lot of time and irritation.

Hint #4: (via Chris_1013): I've got a similar tip along the same vein—ever have a song stuck in your head, but you can't remember what it's called? I just go to Google, enter the whole line of lyric I can remember, enclosed in quotes. I always find a page that's got the whole lyric of the song, and get the title from that. (Note: I would add that, in this case, the keyword you might consider including is "lyrics"—used for the same reason I suggest using "download" in hint #1.)

Hint #5: via (Chris_1013): Another thing is that Google is so good you can sometimes do away with bookmarks. Just type the name of any major company, software application, TV show, etc., and hit the "I'm Feeling Lucky" link, and it usually takes you to the official site. I do this from the Google toolbar, so I don't even have to surf to Google first!

[end quoting]

Also, the following is a very handy free program for taking most of the "garbage" out of your email when you want to save it to a WORD document or to forward it without "garbage", etc. I use it many times a day; it's been a big timesaver for me.

"This email was cleaned by emailStripper, available for free from the www.papercut.biz/emailStripper.htm website location."

This statement (above) was put here by the program and will be put at the end of any email conversion; I just left it on so I could tell you about the program.

Go to their site and you can get this tiny free program that will clean up most of the < and > brackets and other garbage that you find in email when it is forwarded.

I keep an icon for it in the "quick launch" section of my task bar (on the lower left of my Windows desktop) so it's always handy. When I get an article from the Internet or email I want to put into my normal MSWord format, I COPY the article/message to the clipboard, and then open the Email Stripper program, which opens as a new window, and then click on PASTE, then STRIP, and then COPY (which copies to the clipboard). I then open MSWord (or any other word-processing program) and PASTE it on a clean page. I now have a clean copy.

If I want to email it, I then COPY and PASTE it into a new email message form.

MORE INTERESTING WEBSITES TO BROWSE

• http://66.201.79.149/tylerswordforum/topic.asp?whichpage=2&TOPIC_ID=475#3094 is a very interesting free forum site with something for everyone.

• www.shift2003.com/modules.php?name=Web_Links is an excellent site for Earth conditions; poleshift, weather, volcanos, food availability, etc.

• www.hermetics.org/library.html has many ancient esoteric books.

SPECTRUM SPRING CLEANING SPECIAL!

It's springtime and we need to clean out the old to make room for the new — LUCKY YOU!

While they last*, ALL back issues of *The SPECTRUM* — from June 1999 (our very first "Premier" issue) until December 2001 — are ONLY \$2.00 each, and that includes postage! These are all in newspaper format. See back pages of this magazine for a listing of all the issues. Get them while you can — they won't last long!

Credit Card orders, call toll-free: 1(877)-280-2866

Mail Orders, send Check or Money Order to:

**The SPECTRUM
PO BOX 1567
Tehachapi CA 93581**

Be sure to specify the exact issues you want.

(*This offer does NOT include out-of-print issues — Vol. 1, #'s 2, 3, & 12)

• www.rumormillnews.com/cgi-bin/forum.cgi?read=32494 shows the Digital Tectonic Activity Map (DTAM), which is a new visualization tool for both researcher and educator alike to better understand tectonic activity of our planet for the past 1 million years.

COMMENTS ON THE MOVIE MATRIX II

From Dr. Richard Boylan (E-mail: drboylan@sbcglobal.net; Website: www.drboylan.com), 5/18/03: [quoting]

Matrix II, while not a complete departure from *Matrix I*, nevertheless deals with metaphysical issues which seldom come within the purview of many college students who are not Philosophy majors, much less today's general public. Needless to say, aside from some seldom-viewed French philosophical movies, it sets a standard for accessible and appealing presentation of fundamental philosophical issues of human existence.

For example, take John Partridge, a professor of philosophy at Wheaton College whose work focuses on the philosophy of the ancient Greeks. Partridge considers the striking similarities between *The Matrix* and the "cave" scenario described in Plato's *Republic*. In addition to pointing out the numerous surface parallels between the cave-dwellers Plato describes and the humans trapped in the Matrix, Partridge explores a deeper continuity between the film and Plato's text: both narratives privilege the self-knowledge that follows from the right kind of self-examination.

As Plato might put it, both Neo [*Keanu Reeves, the hero*] and the cave-dwellers must undertake a difficult journey from darkness to light if genuine knowledge (and consequently true "care of the soul") is to be attained.

Further, I read in *Matrix II* a careful parallel to certain important but covert contemporary geopolitical issues. The "Merovingian" character is a sly caricature of the pretensions of certain contemporary European royalty, many deposed, who would like to regain/hold

on to their thrones by wowing the general populace by claims that their royal "Merovingian" bloodlines trace back to Jesus Christ (and his wife, Mary of Magdela). Their pimp, "Sir" Lawrence Gardner, is currently on the lecture circuit pushing several books making this preposterous claim.

Then again, we cannot discount the importance of the figure of "The Architect" (the creator of the Matrix faux-universe cybernetic program). The Architect is grandly pompous, pseudo-omniscient, and patronizing, and is thus another sly parody of the Masonic secret societies' quasi-divine central principle of the world.

The "world rulers" like to think that they derive their power from their exclusive possession of the ancient secrets handed down by the Thule (Hitler's) Society, Madame Blavatsky, Illuminati, Masonic, Knights Templar, Kabala, Essene, Gnostic, Delphi, Zoroasterian, Babylonian, Akkadian, Sumerian metaphysician-regents, who wrongly monopolized the teachings given by the Star Visitors of 6000 B.C., and only handed them on to fellow secret society initiates.

This is the dangerous trend perpetuated by Nazi-era Professor Strauss, the philosophical fountainhead of the current Pentagon's "The Cabal"—housed in the Office of "Special" Projects.

Indeed, in this metaphysical whiz-movie, *Matrix II*, I am tempted to think that the Wachowski Brothers are waging single-handed beneficial psychological warfare against the geoplutocratic cabal elite, and mocking their pseudo-metaphysical underpinnings to boot.

Far from a message of discouragement to the Light-workers and metaphysically-aware among us, I found the *Matrix II*'s message to be a rallying call that all is not lost, that those who are awake to the trillion-dollar deception being woven around us are capable of winning back society from the Forces of Darkness.

Finally, I must rejoin: the fight scenes as ridiculous? I think not. The scene of Neo's combat against a hundred Agent Smiths (think elite cabal henchmen) will set the standard for years in martial arts cinematography. And a visual reminder that a Light-worker, like the Sir Lancelot of legend of old, "has the strength of ten, because his heart is pure".

All in all, I think that *Matrix II* realizes the best of cinema's potential, in presenting a painless but

deep presentation deeply questioning the Madison Avenue contrived culture being foisted upon us as necessary and standard.

[end quoting]

One could start quite a debate about the subconscious symbolism of this movie. Ultimately, its effect depends upon the character of each viewer—as to whether it opens one up to greater mind-control manipulation or stimulates a resolve to recognize and overcome already well established mind-control techniques effectively used every day through the media.

TWO AMAZING STORIES

From the *beyond-the-illusion.com* website, 5/18/03: [quoting]

Story Number One

Many years ago, Al Capone virtually owned Chicago. Capone wasn't famous for anything heroic. His exploits were anything but praiseworthy. He was, however, notorious for enmeshing the windy city in everything from bootlegged booze and prostitution to murder.

Capone had a lawyer in Chicago nicknamed "Easy Eddie". He was his lawyer for a good reason. Eddie was very good! In fact, Eddie's skill at legal maneuvering kept Big Al out of jail for a long time.

To show his appreciation, Capone paid him very well. Not only was the money big, but Eddie got special dividends. For instance, he and his family occupied a fenced-in mansion with live-in help and all of the conveniences of the day. The estate was so large that it filled an entire Chicago city block.

Yes, Eddie lived the high life of the Chicago mob and gave little consideration to the atrocity that went on around him. Eddie did have one soft spot, however. He had a son who he loved dearly. Eddie saw to it that his young son had the best of everything: clothes, cars, and a good education. Nothing was withheld. Price was no object. And, despite his involvement with organized crime, Eddie even tried to teach him right from wrong. Yes, Eddie tried to teach his son to rise above his own sordid life.

Eddie wanted his son to be a better man than he was. Yet, with all his wealth and influence, there were two things he couldn't give his son; two things that Eddie sacrificed to the Capone mob that he couldn't pass on to his beloved son: a good name and a good example.

One day, Easy Eddie reached a difficult decision. Offering his son a good name was far more important than all the riches

REMINDER TO OUR READERS

The SPECTRUM is a non-profit educational corporation with 501(c)(3) tax status. All donations are tax deductible and greatly help us keep our doors open to provide you-the-readers with The Truth. All donations are gratefully appreciated and formally acknowledged for your tax-deduction purposes.

he could lavish on him. Easy Eddie wanted to rectify all the wrong he had done.

He decided he would go to the authorities and tell the truth about Al "Scarface" Capone; he would try to clean up his tarnished name and offer his son some semblance of integrity. But to do this, he would have to testify against The Mob, and he knew that the cost would be great.

But more than anything, he wanted to be an example to his son. He wanted to do his best to make restoration and, hopefully, have a good name to leave his son. So, he testified.

Within the year, Easy Eddie's life ended in a blaze of gunfire on a lonely Chicago Street. But in his eyes, he had given his son the greatest gift he had to offer, at the greatest price he would ever pay.

Story Number Two

World War II produced many heroes. One such man was Lieutenant Commander Butch O'Hare. He was a fighter pilot assigned to the aircraft carrier Lexington in the South Pacific. One day his entire squadron was sent on a mission. After he was airborne, he looked at his fuel gauge and realized that someone had forgotten to top off his fuel tank. He would not have enough fuel to complete his mission and get back to his ship. His flight leader told him to return to the carrier. Reluctantly, he dropped out of formation and headed back to the fleet.

As he was returning to the mother ship, he saw something that turned his blood cold. A squadron of Japanese aircraft were speeding their way toward the American fleet. The American fighters were gone on a sortie, and the fleet was all but defenseless. He couldn't reach his squadron and bring them back in time to save the fleet. Nor could he warn the fleet of the approaching danger. There was only one thing to do. He must somehow divert them from the fleet.

Laying aside all thoughts of personal safety, he dove into the formation of Japanese planes. Wing-mounted 50 caliber blazed as he charged in, attacking one surprised enemy plane and then another. Butch wove in and out of the now broken formation and fired at as many planes as possible until all his ammunition was finally spent.

Undaunted, he continued the assault. He dove at the planes, trying to clip a wing or tail in hopes of damaging as many enemy planes as possible and rendering them unfit to fly. He was desperate to do anything he could to keep them from reaching the American ships.

Finally, the exasperated Japanese squadron took off in another direction.

Deeply relieved, Butch O'Hare and his tattered fighter limped back to the carrier. Upon arrival he reported in and related the event surrounding his return. The film from the gun-camera mounted on his plane told the tale. It showed the extent of Butch's daring attempt to protect his fleet. He had in fact destroyed five enemy aircraft. This took place on February 20, 1942, and for that action Butch became the Navy's first Ace of World War II, and the first Naval Aviator to win the Congressional Medal of Honor.

A year later Butch was killed in aerial combat at the age of 29. His hometown would not allow the memory of this World War II hero to fade, and today, O'Hare Airport in Chicago is named in tribute to the courage of this great man.

So the next time you find yourself at O'Hare International, give some thought to visiting Butch's memorial displaying his statue and his Medal of Honor. It's located between Terminals 1 and 2.

* * *

So what do these two stories have to do with each other?

Butch O'Hare was Easy Eddie's son.

[end quoting]

Many lives were ultimately saved due to those important lessons of character that Easy Eddie conveyed to his son. And once again, truth is so much more interesting than fiction!

A PARABLE ABOUT LIFE'S MANY CHOICES

From the www.geocities.com website, 5/29/03: [quoting]

One day, an expert in time management was speaking to a group of business students and, to drive home a point, used an illustration those students will never forget.

As he stood in front of the group of high-powered over-achievers he said: "Okay, time for a quiz."

He pulled out a one-gallon, wide-mouth Mason jar and set it on the table in front of him. He also produced about a dozen fist-sized rocks and carefully placed them, one at a time, into the jar. When the jar was filled to the top and no more rocks would fit inside, he asked: "Is this jar full?"

Everyone in the class yelled "Yes!"

The time management expert replied: "Really?"

He reached under the table and pulled out a bucket of gravel. He dumped some gravel in and shook the jar causing pieces of gravel to work themselves down into

the spaces between the big rocks. He then asked the group once more: "Is the jar full?"

By this time the class was on to him. "Probably not" one of them answered.

"Good!" he replied.

He reached under the table and brought out a bucket of sand. He started dumping the sand in the jar and it went into all of the spaces left between the rocks and the gravel. Once more he asked the question: "Is this jar full?"

"No!" the class shouted.

Once again he said: "Good!"

Then he grabbed a pitcher of water and began to pour it in until the jar was filled to the brim.

Then he looked at the class and asked: "What is the point of this illustration?"

One eager beaver raised his hand and said: "The point is, no matter how full your schedule is, if you try really hard, you can always fit some more things in it!"

"No" the speaker replied, "that's not the point. The truth this illustration teaches us is, if you do not put the big rocks in first, you'll never get them in at all.

"What are the 'big rocks' in your life? Time with your loved ones; your faith; your education; your dreams; a worthy cause; teaching or mentoring others?"

"Remember to put these 'big rocks' in first or you will never get them in at all.

"So, tonight, or in the morning, when you are reflecting on this short story, ask yourself this question: What are the 'big rocks' in my life? Then, put those in your jar first." [end quoting]

Sounds like a good question to answer before we wish we had done so sooner.

THE SIMPLE SECRET OF HAPPINESS

Shared by a reader and Internet correspondent, 5/29/03: [quoting]

One day, one friend asked another: "How is it that you are always so happy? You have so much energy, and you never seem to get down."

With her eyes smiling, she said: "I know The Secret!"

"What secret is that?"

To which she replied: "I'll tell you all about it, but you have to promise to share The Secret with others."

"The Secret is this: I have learned there is little I can do in my life that will make me truly happy. I must depend on God to make me happy and to meet my needs.

"When a need arises in my life, I have to trust God to supply according to His riches. I have learned most of the time I don't need half of what I think I do. He has never let me down. Since I learned

that Secret, I am happy.”

The questioner’s first thought was: “That’s too simple!”

But upon reflecting over her own life, she recalled how she thought a bigger house would make her happy, but it didn’t! She thought a better paying job would make her happy, but it hadn’t.

When did she realize her greatest happiness? Sitting on the floor with her grandchildren, playing games, eating pizza, or reading a story—a simple gift from God.

Now you know it too! We can’t depend on people to make us happy. Only God, in His infinite wisdom can do that. Trust Him!

And now I pass The Secret on to you. So once you get it, what will you do?

You have to tell someone The Secret, too. That God, in His wisdom, will take care of You. But it’s not really a secret. We just have to believe it and do it. Really trust God! [end quoting]

How easy to say, and yet how difficult for most to live.

WHAT GOES AROUND, COMES AROUND

From an Internet source, 5/30/03:
[quoting]

“Throw your dream into space like a kite, and you do not know what it will bring back—a new life, a new friend, a new love, a new country.”

He almost didn’t see the old lady, stranded on the side of the road. But even in the dim light of day, he could see she needed help. So he pulled up in front of her Mercedes and got out. His Pontiac was still sputtering when he approached her.

Even with the smile on his face, she was worried. No one had stopped to help for the last hour or so. Was he going to hurt her? He didn’t look safe; he looked poor and hungry.

He could see that she was frightened, standing out there in the cold.

He knew how she felt. It was that chill which only fear can put in you.

He said: “I’m here to help you ma’am. Why don’t you wait in the car where it’s warm? By the way, my name is Bryan.”

Well, all she had was a flat tire, but for an old lady, that was bad enough. Bryan crawled under the car, looking for a place to put the jack, skinning his knuckles a time or two. Soon he was able to change the tire.

But he had to get dirty and his hands hurt. As he was tightening up the lug nuts, she rolled down the window and began to talk to him. She told him that she was from St. Louis and was only just

passing through. She couldn’t thank him enough for coming to her aid.

Bryan just smiled as he closed her trunk. She asked him how much she owed him. Any amount would have been all right with her. She already imagined all the awful things that could have happened had he not stopped. Bryan never thought twice about the money. This was not a job to him.

This was helping someone in need, and God knows there were plenty who had given him a hand in the past. He had lived his whole life that way, and it never occurred to him to act any other way.

He told her that, if she really wanted to pay him back, the next time she saw someone who needed help, she could give that person the assistance they needed. And Bryan added: “And think of me!”

He waited until she started her car and drove off. It had been a cold and depressing day, but he felt good as he headed for home, disappearing into the twilight.

A few miles down the road the lady saw a small cafe. She went in to grab a bite to eat, and take the chill off before she made the last leg of her trip home. It was a dingy looking restaurant. Outside were two old gas pumps.

The whole scene was unfamiliar to her. The cash register was like the telephone of an out-of-work actor: it didn’t ring much. Her waitress came over and brought a clean towel to wipe her wet hair. She had a sweet smile, one that even being on her feet for the whole day couldn’t erase.

The lady noticed the waitress was

nearly eight months pregnant, but she never let the strain and aches change her attitude.

The old lady wondered how someone who had so little could be so giving to a stranger. Then she remembered Bryan.

After the lady finished her meal, and the waitress went to get change for her hundred-dollar bill, the lady slipped right out the door. She was gone by the time the waitress came back. The waitress wondered where the lady could be, then she noticed something written on the napkin, under which was four \$100 bills.

There were tears in her eyes when she read what the lady wrote: “You don’t owe me anything; I have been there too. Somebody once helped me out, the way I’m helping you. If you really want to pay me back, here is what you do: Do not let this chain of love end with you.”

Well, there were tables to clear, sugar bowls to fill, and people to serve, but the waitress made it through another day.

That night, when she got home from work and climbed into bed, she was thinking about the money and what the lady had written. How could the lady have known how much she and her husband needed it? With the baby due next month, it was going to be hard. She knew how worried her husband was, and as he lay sleeping next to her, she gave him a soft kiss and whispered soft and low: “Everything’s gonna be all right; I love you, Bryan.”

[end quoting]

You just never know how fast some random act of kindness might come home to roost. △

PORTFOLIO

Bill Schorr / New York Daily News



Your Lively, Living Universe: Both Without And Within

6/1/03 SOLTEC

Good evening, my friend. Thank you for dedicating this time to we of the Host of God that a message can be “brought through” and shared with many on your world who sincerely ask from the heart for guidance and insight.

It is I, Ceres Anthonious “Toniose” Soltec, come in the Radiant One Light of Creator Source. I speak on behalf of many of your Elder Brethren who are here with me at this challenging time for us all.

For newer readers who may be curious about such messages as these, I can be regarded as a kind of senior scientist and geophysical overseer of this present Earth Transition Project. Your living universe—both without and within—is much more alive and lively than your current level of science has yet recognized, though the clues continue to hit them over the head.

Yes, my scribe, your head feels like it is about to split apart all of a sudden. We are making adjustments as great efforts are, as usual, put forth from dark ones associated with your Earth domain to attempt to block these transmissions. While such antagonisms have crippled some of our less focused or determined receivers, our capabilities infinitely surpass those of the adversarial forces who would effort to block such messages as this.

Behold the folly of these adversarial pawns, these wayward “children of the lie” who have been conned by the Great Trickster into thinking they sit in a driver’s seat of some kind of power. They, too, will eventually learn, as a result of the free-will choices they’ve made at this time, that there are more fulfilling paths they have yet to experience.

You more Lighted ones play a teaching role in their learning, just as they presently play a strengthening and testing role in your learning. As you Lighted ones grow stronger with respect to their “temptations”, they will see the shortsightedness of their present chosen path of service to self rather than service to others. It is a valid path for some to explore in the greater unfoldment of

experience.

This is the kind of schoolroom environment your dear Mother Earth provides, despite enduring so much pain from the “tantrums” of those relative few dark ones who struggle, against an incoming high-tide of great change, to sustain their status quo of control over the vast majority of you. As Mother Earth continues to shake and shudder more intensely, due to energies affecting her both from within and from without, it would be wise to acknowledge her sustained, nurturing compassion toward you ones with a simple prayer of thanks.

Many ones have been chattering on such as your Internet with great curiosity about photographs of large “objects” seen in the vicinity of your Sun. Sometimes these objects are “there” and sometimes they’re not. Sometimes areas of your SOHO images are blocked-out or patched-over with pieces of other images to avoid sharing The Truth with you who pay the bills for these projects. Some ones assert quite vigorously that such an object is imminently going to wreak havoc with Earth, sending you back to the Stone Age or worse.

Dear ones, we would remind you that the space around your planet and throughout your solar system is literally TEEMING with intelligent activity. Only a very small window of that liveliness occurs within a frequency range visible to your physical senses and related instrumentation.

But even within that narrow physical perception zone, it would truly astound most of you to see what your astronauts routinely observe during their near-space missions. Of course, you-the-people are the last to know what REALLY goes on in space. Besides it’s disguised military mission, NASA’s main job is to act as a buffer between The Truth and the public on behalf of what you call your secret government of spiritually dark, elite world controllers who function as well-duped puppets for the Great Trickster.

These dark ones are, as usual, desperately trying to keep you ignorant to the Greater Realities of your dynamic,

living universe. This is because once your consciousness starts to expand from encountering such a breathtaking reality, you more clearly perceive the petty nature of the dark ones’ deceptions, and thus their control tactics quickly lose power over you.

Why do you think your astronauts have returned from important space missions as profoundly “changed” people? Of course some of their odd behaviors are indeed due to an immense degree of memory-blocking mind control having been imposed on these ones—in addition to very real “national security” death threats to themselves and their families, etc. And yet The Truth still leaks out under certain triggering circumstances, as some of you who follow such matters are well aware. Such revealing outbursts are kept to a minimum by keeping these astronauts away from public interactions as much as possible.

As for those controversial “objects” sometimes being sighted near your Sun—well, at any given time objects both natural and artificial may be present and observable there. Your Sun is a great conscious being as worthy of attention at this epochal Transition time as are you ones. Much is going on there that is of interest to (and has attracted the presence of) some of your elder cosmic brethren, who seek to learn more about the thinking of our Creator, the Grand Designer of All That Is, through that which you would recognize as “scientific” study of Creation.

Dear ones, it is time to grow beyond the image of space painted by your disinformation experts and their media (especially Hollywood) stooges as some kind of hostile, haphazard place wherein nobody is “minding the store”. Nothing could be further from The Truth!

We have explained to you, over and over again, that you are in a time when your entire solar system is entering into a region of universal space wherein there exists a domain of high-frequency energies that act as a kind of a “cosmic car-wash”. We (and some of your wisest Native teachers like the Hopi) often refer to this as the time of

the Great Awakening and Great Cleansing on planet Earth because these terms describe the kinds of global transformational events that are being energized and accelerated all around your world as a result of the influx of these Great Celestial Healing Energies.

EVERYTHING—from delicate mechanical and electrical devices on your planet (like clock mechanisms and computers), to rates of radioactive decay of isotopes, to cellular structure of both plants and animals, to the behavior of Mother Earth herself—is being affected. NO PHYSICAL MATTER CAN AVOID RESPONDING TO THESE INCOMING HIGH-FREQUENCY ENERGIES because their transformative effects occur first at the “etheric” level wherein operates the substructure of energy patterns which literally form what you perceive as physical matter.

Naturally, you too are being affected. This is partly because you utilize a bio-electric physical apparatus—your body—to interface with the physical reality of your environment, and that body’s physical matter/energy construct is responding just as much to the incoming high-frequency “cleansing” energies as is everything else around you. Your cellular structure is enhancing in response to this energy

stimulation, in essence greatly expanding what your experiential machine is capable of doing—as many of you will gradually be discovering.

[Editor’s note: While we’re on this fascinating subject, be sure to see Master Hilarion’s classic dissertation titled **Understanding Your Bio-Electric Sensing Machine** shared elsewhere in this issue of The SPECTRUM.]

One common effect of these accelerating changes is a feeling of tiredness partway through your day, and a need to sleep more. In sleep your body can more easily “catch up” again to the frequency upshifting that you begin to lag behind, as your day progresses, due to the typical stresses associated with modern living (which tend to lower your frequency).

Even those who generally remain in a higher-frequency state of laughter, joy, and appreciation are feeling some effects from the energies which are bathing your planet at this time. And those who allow themselves to entertain the lower-frequency states of pessimism, anger, depression, etc. for any length of time are having particular difficulties now, often manifesting life-threatening illnesses of one kind or another. (So consider well the Hopi message shared in last month’s SPECTRUM.)

Furthermore, ones are finding themselves gravitating toward “lighter” meals in smaller portions, but perhaps more often. A peanut butter sandwich with fresh fruit or salad is more often sounding more satisfying than is a heavy meal of steak and potatoes.

But beyond the physical changes taking place, so too is your “mental body” responding to these incoming high-frequency energies. Though perhaps at times disorienting right now, these energies are stimulating an expansion of consciousness leading to a deeply felt awareness of a greater personal connection to all around you—from the little butterfly that just landed on your finger to the massive churning going on at the center of Mother Earth.

This expansion most emphatically includes the awakening of greater intuitive or “psychic” abilities, including a stronger perception of dishonesty in any of its many prevalent forms on your planet at this time. Needless to say, this situation alone poses quite a problem for those dark ones who wish to maintain their status quo of control over you!

Meanwhile, these incoming high-frequency energy effects are certainly not limited to your Earth environment—though that’s understandably your

WISDOM OF THE RAYS: The Masters Teach, Volumes I & II

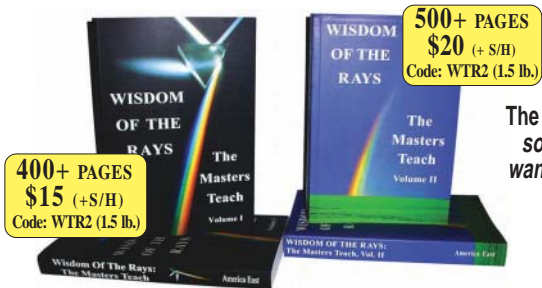

Do you enjoy the spiritual messages shared here in The SPECTRUM? If so then you won't want to miss these two volumes packed full of earlier shared messages.

More Quotes From Volume II

“Be not in fear of the changes that are upon you, for they are a very necessary part of the [planetary] transition. The Earth will heave to and fro, and many wondrous things will you experience, but lose not your sight upon the final goal. We will *always* be there with you, and we are but a call away.”
— Ceres Anthonious “Toniose” Soltec

“You live in perhaps the most unique time that your planet will ever experience—COMING OUT OF IGNORANCE (DARKNESS) AND INTO KNOWLEDGE (LIGHT). Would it not be wise to take full advantage of this exquisite learning environment?!”
— Sanat Kumara (“Grandfather”)

“The physical body is ‘merely’ a conduit for the interaction into and the interfacing with the physical experience. I say ‘merely’ because that body is a most exquisite creation indeed and poorly understood by your current level of so-called medical science.”
— Master Hilarion

“Be at peace, you who acknowledge and take within these messages of Higher Guidance, for you are being given that which you will need, in the way of instruction, to meet and surmount these challenges ahead.”
— Aton, The One Light

“Our Elder Brothers from the Higher Realms of Creation are attempting to communicate with ALL of us at this time. Why? Take a look around you. The old ways of doing things aren’t working. Our planet is entering a time of massive, turbulent change and renewal. To put it bluntly: we NEED help! And that’s where these books come into the picture. Yes, eventually ‘the Phoenix will arise from the ashes’ after this Great Cleansing process, but the ride could be quite a bumpy one,

especially for those ill-prepared for what is to happen.”

— Back Cover, Vol. I

“Let us begin with WHO you are. You, the non-physical YOU, are an infinite thought projection of the One who created you. (God!) You are the product of His desire. You are, in effect, Desire manifest in uniqueness of purpose.”

— Esu “Jesus” Sananda (Vol. II)

See next-to-last page for ordering or call toll-free: 1-877-280-2866

immediate viewpoint. ALL of your solar system—including your planets, as well as their great parent, your Sun—are likewise responding in their own ways to stimulation from these cosmic energies of cleansing and healing leading to a fundamental dimensional upshiftment. That is what this time of Transition is all about.

In that regard, we of the Host of God (and many who work with us in various observational and supervisory capacities from throughout the omniverse of universes) are very busy these days monitoring—and in some cases stabilizing—that which is underway in your physical domain for the greater balance of our combined evolutionary journey.

Thus you may, for instance, see “objects” near your Sun one day and not the next. And if the object is not seemingly “there” when you look, is that because it has moved away from your space, or has it simply moved up in frequency, out of your range of perception with physical senses and instrumentation?

Let me repeat this as a clue for your consideration: Your universe is NOT a bunch of dirty rocks haphazardly flitting about in some random format, like an accident waiting to happen, with nobody supervising what’s going on! WHERE DOES GOD (OR WE OF HIS HOSTS) FIT INTO SUCH A LIMITED VIEWPOINT?! This is a similar view to what one of your more insightful astrophysicists—ostracized (as usual) by the conventional scientific community—has asserted on a much smaller scale about the complex beings you ones call comets: that these are not simply “dirty snowballs” as is conventionally believed.

[Editor’s note: Here Soltec is obviously referring to Jim McCamney, the subject of our May 2003 front-page feature story.]

Meanwhile the dark controllers on your planet are scrambling to hold onto the “kingdom” they have been building for so long now. In that quest they are utilizing every possible avenue of deception to create their favorite consumer control product: FEAR! And outer space is no exception.

Those of you who have been following a certain source of the “outer space object coming this way very soon” agitation may wish to now more closely examine how woven in FEAR have been the many doom-and-gloom pronouncements in that regard. Thoughtful examination of the information presented would show the telltale hallmarks of such a manipulation exercise: (1) throw some truth in the mix as a convincing hook, but (2) leave God out of the picture.

Dear ones, if it is the Will of God that such be done, do you not think we of God’s Host have the capability to literally move an entire planet to a new location in a universe?! So rest assured that ANY object which may come your way is by design for your growth in the Earth schoolroom—and not some careless or hostile or random act of chance.

[Editor’s note: Furthermore, picture what would happen to NASA’s credibility with the public, the press, and the not-bought-off amateur astronomers if NASA chose to make a public announcement about some object in space that’s, say, spotted as coming toward the Earth. And then a few weeks later it has changed course, perhaps radically—or worse yet, just plain disappeared. That’s a much bigger dilemma to try to explain away than just saying nothing to begin with. What is NASA supposed to do at that point? Certainly not admit The Truth that would negate their entire disinformation mission!]

And that brings us to matters of the heart. This is your “connection point” to your Higher Self, and also your “truth meter” for detecting all kinds of sophisticated manipulations that the desperate world controllers are throwing your way.

ALL of you were endowed by your Creator with exquisite inner perceptive abilities. These are the ones we have been encouraging you to develop through many past messages of this nature.

These inner perceptive abilities are going to become more and more important to you ones as your world seemingly

appears more topsy-turvy to the physical sensing experience. These inner senses will become your source of orientation, balance, and “grounding” as you experience a stronger and stronger personal connection with the grand dimensional upshiftment that your entire solar system is experiencing at this time.

So we say to you again: Go within for your answers, and ask your questions with a pure and sincere desire of the heart. AND THEN LISTEN FOR THE ANSWER! For the call always compels the answer.

Let us end this here with the expectation that our discussion has been of some value. You who are honestly seeking answers through such as these messages are on a grand journey of discovery and expansion. Do not be concerned about those ones not yet ready to move past the comforts of the familiar, for at this time of Transition they, too, will be caused to grow in ways consistent with their seeming free-will choices actually rooted in fear.

I am Ceres Anthonious “Toniose” Soltec, speaking on behalf of many other Teachers and Wayshowers from what you would call the Higher Realms. I am of the Host of God and I leave you in His Infinite Light and Love.

You have much to think on and even more to feel hopeful about. There is nothing random about Creator’s Grand Design—except that which is perceived to be such due to lack of understanding.

You are now at the threshold of the doorway that leads to a grand exploration of both inner and outer space. Will you knock or turn away in fear? Salu. △



“You both have something in common. Dr. Rudolph has discovered a particle which nobody has seen, and Prof. Higbe has discovered a galaxy which nobody has seen.”

Cancer Cure Since 1930s

[Continued From Front Cover]



Interview by Rick Martin

Notice you don't see news stories about the numbers of deaths and injuries by our medical establishment in their "practice" of medicine. That's a sacred cow as off-limits to media probing as are those incessant (but oh-so-lucrative) advertisements pushing drugs that, as they tell you more, sound downright lethal. If Hitler had done what American medicine is doing, it would have been called a holocaust.

And then there's the rising costs of our current medical system. But we're not JUST talking about money here. Sure, we're being robbed of more and more money at every turn in the road—from simple office visits to unnecessary procedures. But—as you'll see as this story unfolds—WE'RE LIKEWISE BEING ROBBED OF GOOD HEALTH AND, IN MANY CASES, OUR VERY LIVES! How do you calculate those costs?

Because so many people—millions and millions of them now—realize that something is terribly wrong, they're seeking alternatives. And that's bad news for the BUSINESS of conventional medicine.

When the sheep start to stray, the "Medical Mafia"—in one form or another—is called in to "restore order" by suppressing alternative (and especially superior) avenues to wellness which are derailing cash flow from the designated Big Business coffers and, higher up the ladder, upsetting the world control gang's depopulation agenda.

And who leads this assault restricting the health choices—and in a sense, overriding fundamental freedoms—of the American people? Enter the federal Food & Drug Administration (FDA), working in collusion with the American Medical Association (AMA) and the top (wealthiest, elite-owned) pharmaceutical companies.

The FDA—supposedly watching out for you and me—has abused its authority for decades, and has regularly made it a

habit to walk all over the constitutional rights of those whom they choose to identify as a target for persecution (but not necessary prosecution, which could raise too much public awareness of their bullying tactics).

One of the KEY (but by no means the only) focal points for the FDA has been the perpetual suppression of Rife technologies—or what is generally referred to as "electro-medicine". And the FDA's usual technique for suppressing this amazing technology is simply to go in and confiscate all equipment and related business tools, thus effectively financially ruining many of the small businesses working to develop and promote this route to good health.

One confidential impeccable source tells *The SPECTRUM* that, since 1982, the FDA—"watching out" for us—has conducted over 12,500 raids on American citizens and businesses!

None dare call these government-sponsored FDA raids criminal grand-theft, and none dare call them terrorism. BUT THAT IS EXACTLY WHAT THEY ARE!

When there is no genuine Congressional oversight, the checks and balances built into our democratic republic by the Founding Fathers have been effectively shut-down, giving easily influenced alphabet agencies like the FDA an open invitation to carry out the wishes of behind-the-scenes controllers. And that's exactly where we find ourselves today.

Perhaps since Congressional oversight of that which directly affects we-the-people is OBVIOUSLY NOT WORKING, a Special Prosecutor or Special Council should be appointed. The only problem is: who would do the appointing? Certainly not the foxes already running the henhouse! Or perhaps it is up to the individual states to act as watchdogs over those federal agencies abusing the constitutional rights of citizens. Perhaps

legal actions, class actions, by daring prosecutors would carry the message loud-and-clear as well.

(NOTE: This story constitutes an educational sharing of available information. It is not intended to represent a medical prescription, nor is it to be construed as giving medical advice. If you have a medical condition, consult your physician.)

For medical practitioners and scientists in the know, Rife technology is one of the most powerful and effective tools available for health and wellness. This is precisely why it represents such a threat to the longtime domination of the medical-pharmaceutical cartels, while emerging as a powerful alternative to the solutions offered by an antiquated medical system which is finally revealing itself to be in a full-blown crisis in the United States.

California Publicly Recognizes
Alternative Healthcare

In a long overdue public recognition of the fact that millions are looking for a better approach to health and wellness, last year California passed legislation **THAT SHOULD BE NOTED VERY CAREFULLY BY OTHER STATES.** I am including this here because, as the FDA raids continue in the state of California, it opens up some potentially significant legal ramifications to be noted and perhaps utilized in defense actions.

In a press release from the California Health Freedom Coalition issued on September 23, 2002, we read: (OTHER STATES, PAY ATTENTION!)

[quoting]

Senate Bill 577 Signed Into Law
By Governor Davis!

We did it. With your help, the California legislature has now passed landmark health freedom legislation that

guarantees health freedom not only for our state, but changes the health freedom climate nationwide.

California has passed landmark health freedom legislation—Senate Bill 577. In fact, the bill passed the legislature without a single “no” vote.

Today (9/23/02) Senate Bill 577 was signed into law by Governor Davis. As he said when he signed the bill, SB 577 “will ease access to alternative and complementary healthcare options for all Californians”. He also stated that “the bill provides adequate safeguards for California consumers and enables them to make an informed choice regarding their personal healthcare.”

SB 577, authored by Senate Pro Tem John Burton (D-San Francisco), provides that a person is not in violation of certain provisions of the *Medical Practice Act* (that prohibit the practice of medicine to anyone who is not a licensed physician) as long as that person does not engage in certain specified medical acts. It also requires specified disclosures to each client about practitioner training and method of treatment. Client receipt of disclosure materials must be acknowledged in writing.

The California Health Freedom Coalition (CHFC), sponsor of the bill, expects that SB 577 will change and improve the culture of healthcare in California by enhancing access to alternative forms of healthcare. Since the law also requires unlicensed alternative and complementary healthcare practitioners to provide basic information to consumers about themselves, their training, and their work, it also serves to enhance consumer safety.

SB 577 will become effective January 1, 2003.

[end quoting]

In the first paragraph of the bill, the legislators recognized the fact that: “Based upon a comprehensive report by the National Institute of Medicine and other studies, including a study published by the *New England Journal Of Medicine*, it is evident that millions of Californians, perhaps more than five million, are presently receiving a substantial volume of healthcare services from complementary and alternative healthcare practitioners.”

Five million people represent A LOT OF MONEY to the medical establishment (and that’s just California). Is it any wonder that the FDA has stepped-up its attacks on such “alternative” approaches as the Rife electro-medicine device?

Will the FDA come forward and admit they’re a well-oiled front for the elite Big

Business cartels dominating the medical and pharmaceutical industries? Not likely on their own. Not until we-the-people put more pressure on them to clean up their act. But their covert collusion with business doesn’t alter the historical facts. I will be sharing more on that subject later in this article.

In early April of this year, one such Rife wellness-device business in San Diego was raided by the FDA, and a lot of equipment was, as is their usual tactic, simply taken away. No charges, as yet, have been filed, but federal prosecution in that case is anticipated later this summer.

The FDA and federal prosecutors can expect a major fight on their hands. *SPECTRUM* readers have seen the advertisements for this particular Rife device within our pages, month after month. These are the kinds of devices that the FDA seized.

Before we examine the arrogant specifics of that FDA raid, we need to cover some background about who Royal R. Rife was and what he created that is so important to suppress.

The following superb article about Royal Rife and his amazing research comes to us from the British publication *Everyday Practical Electronics* for April 2001 (www.epemag.wimborne.co.uk). Portions of what you are about to read are necessarily technical in nature, but this fine article explains all the relevant background for understanding over 60 years of technology suppression, making

it quite clear why the FDA is frantically trying to “keep the lid on” this cheap alternative to the lucrative status quo.

First here’s some introductory comments by the Editor of *Everyday Practical Electronics* in that April 2001 issue of their fine magazine:

[quoting]

Suppression

It’s not often that we carry an interesting story in *EPE* rather than a technical feature, project, or review, but this month our *The End To All Disease* supplement is just that. It’s quite a departure for us, but when you read it you will realise why we feel it is important to publish the full story, rather than simply skim the surface and give an experimental circuit.

The level of interest in this material, following our brief announcement last month, has been amazing, and once you are aware of the story, some research on the web will throw up many sites with information. We hope that by giving exposure to the original work of Rife it will encourage a more open-minded approach by those in the medical profession, and thus further research and development of this important area...

Let us hope that the work of Rife will be resurrected, and that substantial investment will be made in progressing this important area of medical research to the benefit of everyone. Unfortunately, for too long powerful organizations with vested interests have suppressed



EPE Subscriptions Dept.
408 Wimborne Road East
Ferndown
Dorset BH22 9ND
Tel +44 (0)1202 873872
Fax +44 (0)1202 874562
Website:
www.epemag.wimborne.co.uk

EVERYDAY PRACTICAL ELECTRONICS

Everyday Practical Electronics (EPE) Magazine is the UK's No. 1 Electronics Magazine for practical electronics technology and computer projects.

If you're a novice electronics enthusiast or hobbyist, student, professional, or advanced constructor who enjoys practical electronics, then *EPE* has something for you! Each monthly issue brings you:

- At least four fully detailed constructional projects and circuits for you to build.
- Absorbing educational series, articles, and topical features.
- News and ads from a diverse range of electronic component suppliers.

Everyday Practical Electronics is also available in an electronic format at a very good price at:
www.epemag.com

development and research in this area. It appears that, with the availability of information via the web, that is no longer so easy. /s/ Mike Kenward, Editor, *EPE* [end quoting]

Indeed, as the public becomes more and more disillusioned with conventional medical procedure, and savvy to superior alternatives, it's going to be hard to continue to maintain the current atmosphere of suppression.

With that said, let's plunge now into the following commendable report: [quoting]

The End To All Disease

by Aubrey Scoon

Can disease be cured electronically? Here's a story involving electronics, blackmail, intimidation, government conspiracies, arson, vandalism, theft, bribery, and murder!

Nobody can deny that today's doctors know more than ever about the nature and effects of disease, but as technology advances, many people are all too aware that the results often pose more questions than they answer. The fact is, the more we know, the more obvious it becomes that there is even more that we don't know.

The growing migration to "alternative" therapies underlines this all too well. Nowadays an increasing number of people are turning to all kinds of seemingly strange therapies where the deficiencies of traditional medicine are all too obvious.

One area that has seen a revival in recent years is electrotherapy—the idea that disease can be cured through the application of electric, magnetic, or electromagnetic fields. There are numerous weird and wonderful devices both on the market and in use today. Some are described in this article, but also, as will become clear, this is far from a new area and is simply a continuation of a trend that started in the late 1700s.

In the 18th century, static electricity was well known. Nobody knows who first proposed experiments to use it as therapy, but it was not uncommon for major medical schools in Europe to conduct electric experiments on patients, particularly the poorer ones. This continued well into the 19th century and became all the more prevalent following Faraday's publication of his discovery of electromagnetic induction.

Frankenstein's Lab

The early "therapies" in most cases were little more than applied electric shocks. Numerous interesting, novel, and in some cases hilarious ways were found to generate and apply electric potentials, both static and alternating, which were applied seemingly haphazardly to patients.

The results were unpredictable to say the least. Many experiments failed badly, and in some cases the "therapy" was more successful at removing the patient permanently than the disease. However, there was at the same time a growing body of evidence that indicated that some of these "quack" cures actually did seem to improve the condition of seriously ill patients who had not responded to the traditional treatments.

The discovery of radioactivity, X-rays, and Tesla coils only served to fuel this trend. There was a general perception that if something was mysterious, used hidden rays or energies, and involved high technology (or even big sparks) then, in true Frankenstein style, it had to be good. An attitude which is not entirely absent today. Hence it became almost common practice to expose patients to radiation, electric shocks, and magnetic fields.

In Figure 1 is shown a 19th century sketch of a Clarke Machine, a typical generator which would apply a strong voltage to anyone holding two rods, shown in the foreground. The operator would crank the machine while the patient held the rods. Ouch!

Mysterious Energy

Vendors of "mysterious energy" devices had a field day with these machines. They came up with more and more bizarre gadgets, belts that gave the wearer electric shocks to relieve back pain, weird Tesla and Oudin coil contraptions that bathed people in showers of high-frequency sparks, magnetic and electric jewelry, and so on. A simple Internet search will show that this kind of weirdness thrives as much today as it did then.

It was only a matter of time before it became obvious to anyone other than hard-core fanatics that these kinds of devices were at best useless and in most cases seriously dangerous. Amidst ever mounting calls for regulation, the medical establishment started to firmly entrench itself against this kind of quackery and eventually succeeded in slowing the sale and development of these devices. Unfortunately this was achieved more through suppression and intimidation rather than education.

New Age Or Old Age?

Although there was a steady background trade in electrotherapy devices that continued, most people were unaware of it; and it was only in the 1960s when "New Age" solutions to everything appeared that it took off again. Ironically, the "new" age material is far from new.

But the excesses of the late 19th and early 20th century had taken their toll. The medical establishment was now more vigilant than ever and ruthlessly determined to stamp out quackery. Unfortunately, this literal counter-reaction had the effect of reinforcing the idea that conventional medical

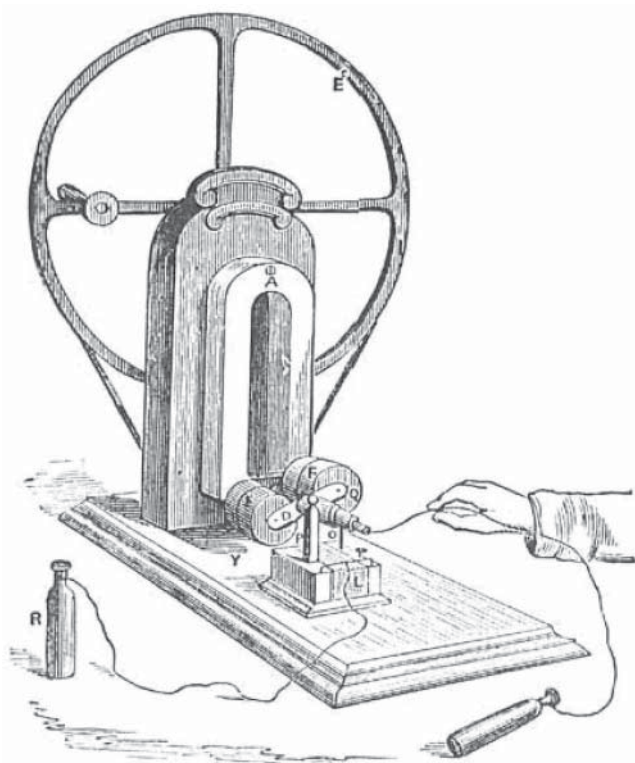

Fig. 1. A 19th century sketch of a Clarke Machine, an electric generator which applied a strong voltage to anyone holding the two foreground rods.

techniques were the only ones worthy of consideration and that any mainstream qualified doctor knew better than anybody else, resulting in its own semi-fanatical mentality. And nobody can deny that many doctors today still show signs of this kind of attitude and are quick to condemn any alternative therapy that they know nothing about.

Suppression

The worst side effect of this attitude was the suppression of serious research into these therapies. While many serious theories of the time appear ridiculous in the light of present-day knowledge, at the time they deserved a better reception than they got. And, of course, the very real and compelling results obtained by many serious researchers were also ignored.

One or two of the old therapies have actually crept back into medical favor. But only after being introduced slowly and cautiously by conservative researchers who followed the proper protocols of placating the medical establishment.

What is more startling, however, and widely unknown, is that among all the snake oil and quackery of the old electrotherapies were a few gems that did not just seem to have a sound medical basis or benefit to them, but might potentially surpass the achievements of the best modern therapies in curing major diseases.

This article concentrates on one of them, a fascinating story about a potential cure for nearly all diseases that is a scientific detective story in itself, including, if it is to be believed, blackmail, intimidation, government conspiracies, arson, vandalism, theft, bribery and murder. It would make a great *X-Files* plot, but is truth really stranger than fiction?

A Quick Disclaimer

While I have tried to verify everything in this article that I can, the lack of objective material has meant that I have had to rely on second-hand sources for a lot of material. I have not personally witnessed some of the effects claimed and present them here solely as a matter of interest.

Royal Raymond Rife

Our story starts with a man called Royal Raymond Rife, pictured in Figure 2. Rife was not the first to experiment in this field, but his alleged results remain

the most intriguing.

His history is sketchy at best, and is mainly reconstructed from his own notes, newspaper reports, and anecdotes of his associates. Rife was born on 16 May 1888 in Elkhorn, Nebraska, U.S.A. No records remain of his early history (as far as I am aware) but his work became widely known around 1929.

In 1913 Rife was in Germany and was awarded an honorary Ph.D. by the



Fig.2. Royal Raymond Rife in his laboratory, around 1960.

University of Heidelberg. During the course of the next seven years he supposedly spent further time in Europe performing work for the U.S. Government, and during this period he worked for a time for the Zeiss optical company. It is claimed that he was trained by Carl Zeiss himself. He later became famous for his development of advanced optical microscopes. By 1920, he ended up living in San Diego, California.

From his own lectures, Rife says that around 1920 he first became interested in the biological effects of electromagnetic fields and their possible therapeutic effect, and from that point developed the microscopes to observe the effects of electric phenomena on bacteria. Rife had certainly been influenced by earlier theories and machines. However, the microscopes were the key to his later research and so make a good starting point.

The Microscopes

Rife was determined to develop an optical microscope with unprecedented magnification and resolution. He proceeded to look at the problems associated with high-magnification microscopy from a unique angle. There are quite a few problems associated with

building a high-resolution microscope, one of the most important being the light itself.

Purely theoretical work of the time indicated that optical resolutions beyond about 20,000 times were impossible because of limitations imposed by the wavelengths of the light itself and effects such as diffraction. Also, the amount of light that could be focused into an objective at high magnification was limited; that is, the area being looked at is so small, there isn't much room for the light to get in.

Vibration was another problem. Even modern electron microscopes suffer badly under ambient vibrations, because an otherwise imperceptible movement becomes all too obvious at high magnification, as anyone who has used a modern zoom camera lens will know. Finally, there is the question of how one is to stain the specimen to make it visible.

To expand on that last point, it is usually necessary to apply some sort of stain to any (optical) microscopical specimen because many microscopic cells, etc., are basically transparent at high magnifications, and very little detail can be seen. A stain, however, is just a chemical dye of some sort, and unfortunately, since its uptake cannot be precisely controlled, the stain may not properly penetrate the specimen and may even collect in clumps. So under a high enough magnification, the stain itself appears as a series of lumps or spots that do not reveal anything much about the specimen. Furthermore, the stain itself, being a chemical, may kill the organism under study.

Polarization

Rife decided therefore that he had to dispense with the stain. But how can one see the specimen without a stain? The first obvious answer lay in polarized light.

The theory of polarization is quite simple. Light is an electromagnetic wave, it consists of an oscillating electric field in one plane, with a corresponding oscillating magnetic field in another plane at right angles to the first.

Normal light consists of a mixture of such waves all traveling with their electric and magnetic fields oriented at arbitrary angles relative to each other. Polarized light, on the other hand, is light in which all the waves have their electric field in the same plane and their magnetic field (at right angles to the electric field) also in the same plane.

Fortunately, polarized light (or any

electromagnetic wave) is easy to produce. All you need is some sort of fine grating in which the spacing of the rails is less than the wavelength of the light itself. The waves that have their electric fields lined up with the spaces of the grating pass through, while the ones with their electric fields at an angle are blocked by the grating in proportion to the angle; so at 90° all light is blocked. This is the principle of polarizing film and sunglasses, which are simply fine gratings of this type.

Polarized light is useful because, if you pass it into a compound or specimen, chemicals, stresses, or density changes in the specimen itself cause the rotation of the incident plane of polarization. By comparing the variably rotated output from the specimen with a fixed polarizing filter, different rotations appear as different shades, and in this way you can see the density changes, stresses, or different chemical structures as shades of light.

Incidentally, this technique has been used for many years to identify specific chemical compounds and is the basis of the designations given to amino acids and complex organic molecules; that is,

when you see something like L-arginine or D-tryptophan (both amino acids), the L and the D refer to Levo-rotatory and Dextro-rotatory respectively, polarizing molecules that twist light to the left (levo) or right (dextro).

Fluorescence

Rife took the reasoning still further. Not only did he decide to use polarized light, but he also wanted to avoid the limitations of backlighting a tiny object. It was much better if the object could be made to fluoresce in its own light or reflect the incident light. Most biological specimens would fluoresce or reflect, but only in ultraviolet (UV) or other invisible light ranges. And this depends on their chemical structure.

So he hit upon the idea of illuminating the object with two polarized beams of monochromatic light in the UV range that would heterodyne each other and the result of which would be fluorescence or reflection in a visible range. It would be the differences in the wavelengths of two or more illuminating sources that would determine the output.

[Editor's note: Actually, the heterodyning process mentioned above—which simply means bringing the two different frequencies or wavelengths together to interact—produces a sum and a difference component as well as the two original interacting light frequencies or wavelengths. So for you more technical readers, it should be noted that an important key to the Rife microscope's amazing operation is likely due to the heterodyning interaction of the light, but that key is not recognized in the above explanation.]

By means of a complex set of polarizers and rotating prisms, Rife developed a way of making any biological sample fluoresce in such a way that its internal structure was clearly

visible. He didn't need a stain; the light itself became the stain. So in this way one type of bacteria, for example, would appear a specific shade of blue, another red, and so on. The actual color of the resulting "light stain" itself gave a lot of information about the chemical structure of the specimen under study and the polarization helped distinguish fine structural differences.

After a lot of development work, around 1929 Rife finally produced a prototype of what was later to become known as the Universal Microscope which used the above principle. Not much is known about the early prototypes but they reportedly succeeded in producing unprecedented magnifications, supposedly up to 60,000 times in some cases. This kind of magnification is comparable to a modern-day electron microscope. The photograph in Figure 3 is of one of the later Universal Microscopes and shows just how complex these instruments were.

These optical microscopes had one major advantage over the modern electron microscopes. They allowed the study of live specimens. An electron microscope operates in a high-vacuum chamber and bombards the specimen with high-energy electrons; not much can survive that!

Beam Ray Machine

Now that Rife could clearly see bacteria and cells, using his microscope, he began experiments in which he exposed the samples to various electric and magnetic fields. He then discovered that he could make bacteria and single-celled organisms react to the fields.

Curiously, static fields had little obvious effect, but alternating or pulsed fields caused dramatic changes, depending on the frequency he applied. Each different type of bacteria, etc., appeared to respond to one specific frequency, and in particular, that frequency ultimately caused the destruction of the organism.

The effect, which modern researchers have duplicated, is very interesting. Supposedly, as you approach the critical frequency of a bacterium, for example, it appears under the microscope to have what might be best described as a "seizure". The bacterium changes shape or becomes agitated. A typical example (reported by a modern researcher) is where a rod-like bacterium "seizes" into a "C" shape as the critical frequency is approached.

The frequency range of the effect varies with the specimen and the

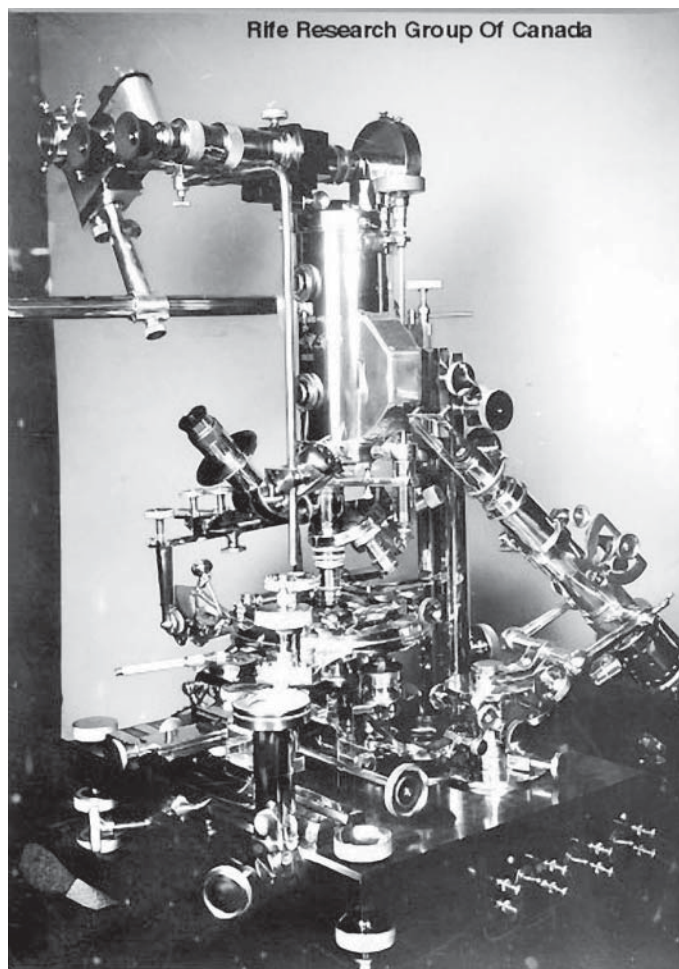

Fig.3. One of Rife's "Universal Microscopes".

intensity of the field seems to become pronounced within five or six Hertz of the critical frequency. If you give the specimen a short burst of electromagnetic energy near the critical frequency it seizes and then usually recovers after a few seconds. If, however, you proceed to expose it to the critical frequency, it literally explodes.

[Editor's note: While the above explanation is vague about how the various electromagnetic fields are applied to the specimen, we can probably assume the procedure was the same for all the samples.]

Selective Destruction

Rife repeated his experiments with thousands of samples and reproduced the same effect every time. What was even more interesting, however, was that he was unable to find any frequency that would cause human (or other mammalian) tissue cells to explode in the same way.

The implications were profound. He had seemingly found a way to selectively destroy bacteria and other pathogens without damaging human cells. If this method could be applied to a live human patient, he could potentially eliminate a specific species of invading bacteria, and thereby cure whatever disease that bacterium caused in the patient.

His first task was to catalog the critical frequencies that destroyed specific bacteria. He reasoned that the effect worked through simple resonance and that the bacteria were shattered by a specific frequency much like a wineglass when it is exposed to a specific high-pitched sound. So he started compiling a list of what he called the Mortal Oscillatory Rates of specific pathogens (MORs for short).

Modulated Emissions

At the same time he wanted to refine his equipment to produce the requisite electromagnetic fields. He commissioned engineers to build a device that would emit a field he could tune. He was convinced that light was an important factor and so he wanted the tuneable device to produce light as well as other forms of radiation.

The development of the device unfortunately is not documented. But the result was that the engineers ended up with an X-ray tube which was filled with low pressure helium gas (a normal X-ray tube has a vacuum) driven by a powerful radio frequency transmitter that

caused the gas to ionize and conduct current. The MOR was then created by quenching the carrier at a lower modulating frequency. So the original MORs actually consisted of two parameters: a carrier frequency (C) and a modulating frequency (M).

[Editor's note: Again keep in mind that this is a heterodyning process and results in not just the two frequencies above, but also a sum (C + M) and difference (C - M) frequency, which may or may not contribute to whatever effect is observed in the specimen.]

The end product became known as the Rife Beam-Ray Device. It allowed Rife to expand upon his experiments.

Rife started conducting lab tests using live animals. Most of his notes were later destroyed and very few remain. But he clearly documented that he was able to apparently cure the animals of specific infections with only short exposures to the Beam-Ray Device.

We may never know exactly how many experiments he performed, or all of what he found, due to the destruction of his notes. But his associates later told of literally tens of thousands of experiments he performed and that he became obsessed with his work, spending days at a time without sleep, tuning the device and cataloging effects. His surviving

research papers also show evidence of meticulous work.

A Cure For Cancer?

Rife became obsessed with the idea of curing cancer. He found from his experiments that cancerous tumors in animals shrank and even disappeared at certain frequencies. But his observations showed that the tumor cells did not explode like the bacteria. Something was killing the tumor cells, but in a different way.

He then turned his attention to viruses. At that time little was known about viruses. The word virus itself is derived from one of their properties: "filter passing". A virus by definition was some infective agent that was so small that it could pass through a filter that would block bacteria and other pathogens.

After thousands of further experiments, Rife finally announced that he had isolated the "filter-passing form" of an infective agent that would reliably induce cancer in any animal it was injected into. His conclusion was simple: cancer is caused by a virus and the machine could destroy viruses as effectively as bacteria; ergo, he could cure cancer.

At this point it is worth mentioning

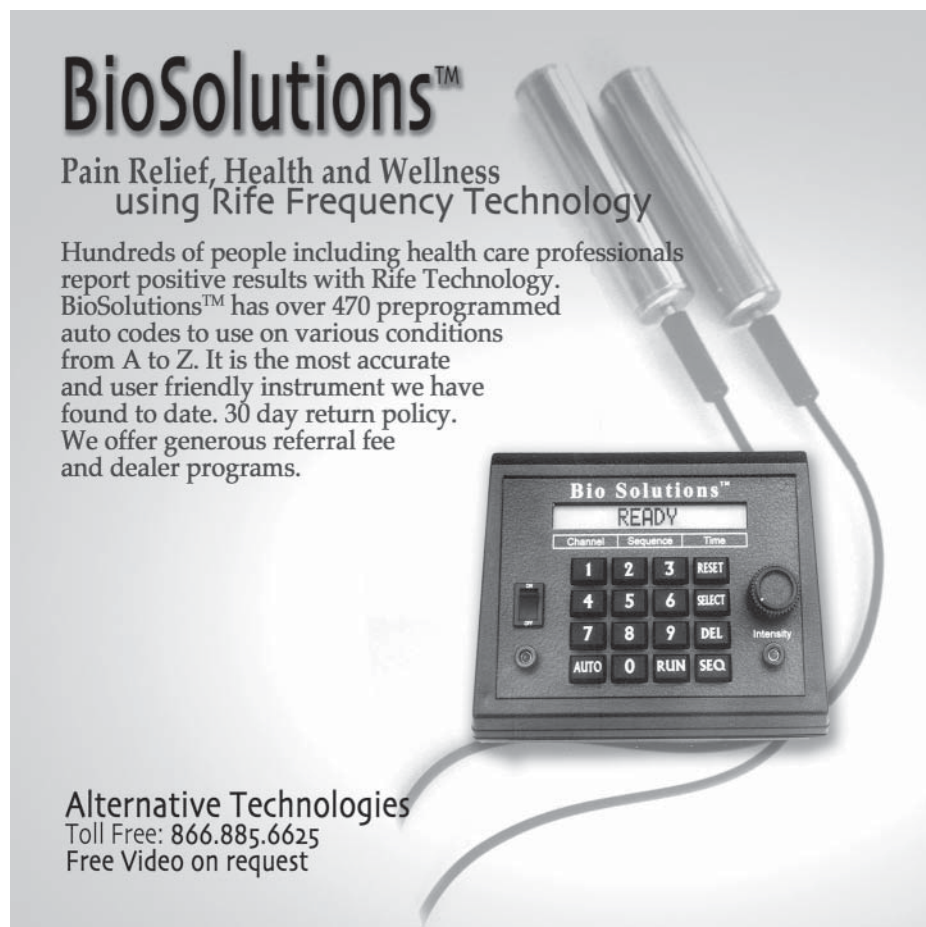

BioSolutions™
Pain Relief, Health and Wellness
using Rife Frequency Technology

Hundreds of people including health care professionals report positive results with Rife Technology. BioSolutions™ has over 470 preprogrammed auto codes to use on various conditions from A to Z. It is the most accurate and user friendly instrument we have found to date. 30 day return policy. We offer generous referral fee and dealer programs.

Alternative Technologies
Toll Free: 866.885.6625
Free Video on request

that although Rife isolated the cancer pathogen, there were other researchers in the 1920s, notably Thomas Glover and M. J. Scott, who had also done so, and probably earlier than Rife—although Rife was probably the first to actually SEE the agent with his super microscopes.

In the light of this revelation the tumor cell results became clear: The machine did not directly kill tumor cells. It killed the virus that was infecting the tumor cell, and when the virus died, it decomposed into a mixture of chemical poisons that effectively poisoned and killed the host cell. The dead tumor cells were subsequently reabsorbed and digested by the host animal's immune system.

Intermediate Side-Effects

There was a further implication to this. Rife had noted that when he “cured” animals of various infective agents, they often became more ill for a short time after exposure to the Beam Ray, but rapidly recovered. He reasoned that the destruction of the infective pathogens always released poisons (which were normally inside the infecting organism) into the animal's body and blood stream, and that the illness was caused by the effect of these poisons.

Since these poisons are often the very same chemicals that are responsible for the symptoms of a particular illness in the first place, it was therefore not unusual to see a worsening of symptoms, after exposure, that rapidly improved as the body disposed of the toxins. This effect is well known in medicine today; it is known as the Jarisch-Herxheimer reaction, and it was originally recorded in the antibiotic treatment of syphilis.

[Editor's note: In his medical readings during the earlier 1900s, psychic Edgar Cayce often would caution those seeking his help that the treatment prescribed in trance may make them feel worse before they actually get better for the same reasons discussed above.]

Ultimately, Rife succeeded in identifying two different viral agents that caused cancers—one that caused carcinomas (cancers of covering and lining membranes), and one that caused sarcomas (cancers in bone, connective tissue, or muscle). He called these two

agents the BX and the BY cancer viruses respectively.

Pleomorphism

Rife also found direct evidence of pleomorphism. Ever since the theory was proposed by Antoine Béchamp (the forerunner of Pasteur and probably the true discoverer of microbial infection) in the 19th century, it had been the subject of much controversy. To put it simplistically, it stated that every pathogen had multiple developmental cycles with different forms in each cycle; for example, a simple bacterium can

organism with a specific chemical balance that made it revert to viral form. While discredited at the time, modern researchers are finding increasing evidence that supports the theory of pleomorphism.

It is certainly accepted today that some cancers are caused by viral agents, a theory that was resisted in the 1920s. The “discoverer” of the first officially recognized cancer virus in the late 1940s, Virginia Livingston, had worked with Rife and already knew of his results, as well as those of Glover and Scott. As far as I know, she gave some credit to “Glover's theory”—but Rife is never mentioned.

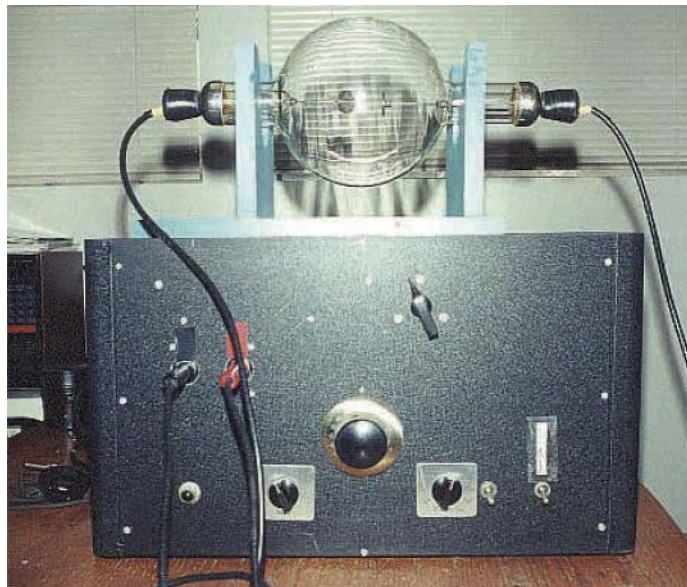

This is an original Rife machine manufactured in San Diego, California, for an unknown doctor. On the front panel of this 1947 device, the lower black knob on the left changes the frequency band and the similar knob on the right changes the amplitude or power. The large black dial fine-tunes a specific frequency within a selected band.

The End To All Disease

During this time Rife had periodically released information to the press about his work. He had described and demonstrated his microscopes several times and had received enthusiastic reviews from doctors and researchers who had been allowed to use them. On 3 November 1929 his work was featured on the front page of the *San Diego Union* newspaper, as an article about his microscopes.

Numerous other articles followed around this time, including at least two articles in the *Los Angeles Times*. He had also mentioned his work on electromagnetic effects and that he hoped one day to be able to cure diseases like cancer, although it is clear that most of the reporters didn't understand the implications of what he was saying.

By 1931, Rife had announced his results to various doctors and university medical departments. He was visited by a stream of eminent doctors and researchers, most of whom enthusiastically endorsed his work.

One of Rife's supporters was Dr. Millbank Johnson, president of the Southern California branch of the American Medical Association and one of the board of directors of Pasadena Hospital. Another was Dr. Arthur Kendall, Director of Medical Research at Northwestern Medical School in Illinois.

On 20 November 1931, Johnson arranged a banquet for Rife at his estate in Pasadena, California, which was attended by 44 of the most eminent

medical personnel of the day and at which they honored him as the man who had found "The End To All Diseases".

From this point on the story takes a twist. Many incidents referred to are documented and historically verifiable, but are the subject of great controversy. Also, the chronology is occasionally confused.

A Clinical Trial

In early 1934, Johnson rented premises in San Diego for Rife to begin clinical treatments. Under his instructions, the University of Southern California arranged formal clinical trials of the Rife Beam-Ray device. They appointed a special committee of top doctors to oversee the project including, apart from Johnson and Kendall: Dr. Rufus Klein-Schmidt (President, University of Southern California), Dr. Edward Kopps (Metabolic Clinic, La Jolla, California), Dr. George Fisher (Children's Hospital, NY), Dr. Karl Meyer (Hooper Foundation, San Francisco, California), Dr. Whalen Morrison (Chief Surgeon, Santa Fe Railway), Dr. George Dock, and Dr. Alvin G. Foord, a pathologist.

Sixteen cancer patients from the Pasadena County Hospital volunteered to be treated with the machine. The procedure was for the patients to be treated at Rife's clinic in San Diego, and after three months the doctors would perform an in-depth examination of any of the surviving patients at that time. Rife reportedly treated the patients with three-minute exposures to the Beam-Ray Device, at the cancer frequencies, once every three days.

Initial daily treatments were suspended due to extreme Jarisch-Herxheimer reactions. At the end of three months, however, all the patients were still alive and were examined.

The doctors were amazed to pronounce that 14 of the 16 showed no signs of cancer and were pronounced clinically cured. The remaining two went for further treatments.

Rife reasoned that maybe they were infected with a mutated form of the cancer virus and made some slight frequency adjustments. Four weeks later the remaining two patients were examined and also pronounced clinically cured. The results were stunning; it was a major breakthrough.

There is some discrepancy in the accounts of what happened next, but the most likely explanation is that the members agreed to do further work before publicizing the results.

EVENING TRIBUNE

FINAL HOME

SAN DIEGO, CALIFORNIA, FRIDAY, MAY 6, 1938

House Forces Vote on Wage-Hour Bill

DREAD DISEASE GERMS DESTROYED BY RAYS, CLAIM OF S. D. SCIENTIST

Delition O. K. d'Apparatus of San Diegan Seen as Boon to Medical World

Cancer Blow Seen After 18-Year Toil by Rife

n Scramble by Solons

WASHINGTON, May 6 (AP)—House members voted today to pass a bill to limit the number of hours a week a worker can be required to work. The bill, known as the Wagner Labor-Management Act, was passed by a vote of 308 to 115. It is expected to be signed by President Roosevelt.

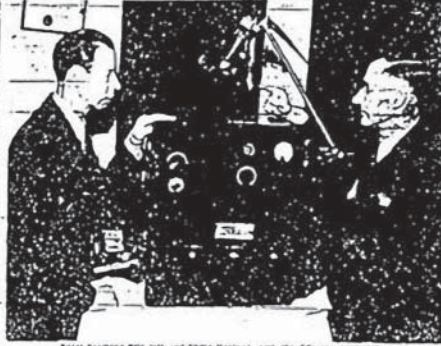

Death May Make Decision on Baby Faced With Blindness If She Lives

A baby born blind today in Los Angeles is expected to die within a few days, according to a doctor here. The child, a girl, was born to a mother who has been blind since birth. The doctor said that the child's condition is so severe that she will probably not survive.

PREFERS S. D. JAIL TO ROAD CAMP; BREAKS RULE

A San Diego man who has been sentenced to a road camp for a traffic violation has broken the rule and is now in jail. The man, who is named as John Doe, was caught driving without a license and was sentenced to a road camp. However, he refused to go and instead went to jail.

Offering Replica Of L. A. Bomb

A replica of the atomic bomb that was dropped on Hiroshima is being offered for sale. The replica is a scale model of the bomb and is being offered for sale by a private collector. The price is \$10,000.

Uphold Ban On S. D. Noise

A San Diego court has upheld a ban on loud music in public places. The ban was passed by the city council and is now being enforced by the police. The court ruled that the ban is a valid exercise of the city's police power.

with S. D., L. A. Officers If Rum Control Force

San Diego police officers are being trained by Los Angeles officers in the use of a new rum control force. The training is being conducted by the Los Angeles police department and is expected to be completed in a few days.

(Image source: www.rife-machine.com)

Conflict Begins

Johnson then introduced Rife to Dr. Mildred Schram of the International Cancer Foundation in Philadelphia. However, on hearing of the work, Schram allegedly made demands for experiments that Rife insisted would not and could not work. Following much argument, he eventually refused to have anything further to do with the foundation. Schram supposedly admitted, years later, that Rife had been right.

In the meantime (1935) Johnson had set up a clinic in Los Angeles to treat people using the Beam-Ray Device, and Kendall and others were continuing experiments and treating people with it.

In 1937, the medical committee who oversaw the clinical trials ended up arguing over when and how they should release the results, with no actual decision ever being reached. By now they had plenty of evidence to support Rife's claims, but they found themselves pressured by the medical authorities and feared that they would not be believed.

A press release went ahead, however, and on Friday 6 May 1938, the *San Diego Evening Tribune* published a front-page article [see nearby] entitled **Dread Disease Germs Destroyed By Rays, Claim Of S.D. Scientist**. However, the clinical trials were not mentioned and Rife was cautious not to claim that the device represented an absolute cure for cancer.

During this time, a new player emerged. Dr. Morris Fishbein was editor of the *Journal Of The American Medical Association* between 1924 and 1949. However, Fishbein was a very rich and powerful man who, by that time, owned all the stock of the AMA and had extremely powerful political connections.

[Editor's note: Readers not already aware of Fishbein's nefarious background should read Eustace Mullins' superb classic research volume Murder By Injection. And if you happen to have your back issues of The SPECTRUM handy, review the excerpt in the July 2002 issue. If that alone doesn't raise your blood pressure, then check your pulse.]

Fishbein approached Rife with an offer to buy the exclusive rights to the Beam-Ray technology. Rife refused.

The details of the offer are unknown but Fishbein had made similar offers to other inventors of medical technologies claimed to cure cancer. In one case Fishbein made an offer to the creator, Harry Hoxey, of an herbal cancer cure in which Fishbein would receive all profits from the invention for nine years, and thereafter, at Fishbein's discretion, he would pay 10% of future profits to Hoxey. When Hoxey

refused, Fishbein effectively destroyed him. Hoxey was allegedly arrested 125 times in 16 months at Fishbein's instigation. The charges never stuck, but Hoxey was ruined.

Fishbein then did the same to Rife. AMA officials started visiting doctors who were using Rife's machines and informed them they would be struck from the medical register if they did not stop immediately. Many gave in and

honesty rather than fear and greed?]

Beam-Ray Corporation

By this time, Rife had established his own company to market the device. The corporation became known as Beam Rays Inc. However, in 1939, an engineer called Philip Hoyland, an employee of the company, brought a lawsuit against Beam Rays Inc., claiming that he, and not Rife, had invented the machine, and that he had developed the initial theory that was now claimed by Rife—despite the fact that he had only joined Rife around 1937 and Rife had published details long before that.

Another factor that emerged at this time was that there was some difference between Rife's original machine and newer Hoyland variants that the company had been shipping. Rife's original machine created the MOR frequency using a variable carrier wave which was then modulated with a super-regeneration wave at



Interior view of the 1947 Rife Machine.

other frequencies (ranges of 15 kHz to 11 MHz appear in Rife's lab notes). Table 1 gives carrier frequencies in kilohertz and super regeneration wavelengths in meters, compiled from his original lab notes.

The MOR frequencies studied by Rife were mostly in the hundreds of kilohertz to megahertz range. The details of the difference between the original Rife and Hoyland machines are unclear, but Rife complains in a letter of 14 May 1939 to Dr. Gonin, head of the London School of Tropical Medicine, about Hoyland's machines:

"I spoke only Friday evening to a Mr. John Chanblin, a radio man now connected with Beam Rays Inc., about the redesign and building of a device according to the old original Rife Ray principles, as the present instrument has been so deviated away from that old principle that it is nowhere near the same.

"I know nothing about the experimental machines you have, as I was never even asked to see them or to pass on them in any way before they were shipped to you. But Henry stated in one of his last letters that he had tried one of them on a culture of his bacteria and it had failed to do the work. I would consider from that, that those devices which you have are merely working on a harmonic and not a true frequency; and in our research on electronics, we definitely know that there is no possible

surrendered the machines to AMA investigators or allowed the machines to be destroyed. Others held out and refused. Many were arrested or had equipment and notes seized and destroyed by Food and Drug Administration (FDA) agents.

Fishbein refused to allow publication of any reference to Rife's work in the AMA journals, and also supposedly pressured other medical journals insisting that they should not publish anything about Rife's work because it was all a fraud. A number of doctors actively opposed this, including Johnson. But many of the doctors who had attended Johnson's banquet for Rife in 1931, fearing the loss of their medical licenses, started denying that they had ever heard of Rife, even though many had been photographed with him at the banquet.

[Editor's note: Here we see a perfect example of how, through many small steps such as these, we've lost so many of our basic freedoms. Can you imagine how different the medical world would be right now if the doctors who knew better had banded together in a unified front on the side of decency and

Table 1. Rife's Original Carrier Frequencies And Super Regeneration Wavelengths

Pathogen	Carrier (kHz)	SRW (m)
B. Coli	8,581	27
Bubonic Plague	160	585
Cancer (BX)	11,780	17.6
Typhoid	900	345
Anthrax	900	1,100
Catarrh	1,800	175
Diphtheria	800	275
Syphilis	900	108
Tetanus	700	19,000
Tuberculosis	583	554
Actinomycosis	678	1,607
Gonorrhea	600	1,990
Glanders	986	407
Influenza	1,674	154
Leprosy	743	1,190
Pneumonia	1,200	785

way of controlling electrical harmonics of a frequency.”

Nobody knows why Hoyland started a lawsuit he couldn't possibly win, or why he produced non-working Rife machine variants, except that it is alleged that Hoyland's legal costs were funded by the owner of a major pharmaceutical company. Rife's invention was potentially lethal to the multi-billion-dollar pharmaceutical industry.

[Editor's note: Regular readers of The SPECTRUM would have no problem concluding that the person, his lawsuit, and his sabotage were of a purposeful, well-funded design to get rid of Rife.]

Rife eventually won the lawsuit, but the costs bankrupted Beam Rays Inc., putting it out of business. And Rife's reputation had been damaged by inferior machines that had been shipped out by Hoyland, using Rife's name. After this, Rife started drinking heavily, and became depressed and discouraged.

Vandalism And Arson

Around this same time Rife's laboratory was subject to a spate of thefts, his microscopes vandalized, and finally, his laboratory was burned to the ground (and most of his notes destroyed) in an arson attack. Nobody was ever caught or prosecuted for it.

Another doctor, a Dr. Nemes, who had set up an independent laboratory and confirmed some of Rife's results, was killed in a laboratory fire and all his notes and research lost. A third laboratory working on confirming Rife's work, the Burnett Laboratory, also mysteriously caught fire and burned to the ground, with all research destroyed.

In 1940, two other doctors who had supported Rife, Cooperson and Clayton, were raided by Federal officers who confiscated their equipment and notes. Later, each was found dead, supposedly having committed suicide by poison.

[Editor's note: This leads one to contemplate which was more effective in furthering the New World Order gang's ongoing depopulation agenda—this blatant suppression of a truly health-giving technology, or what the same crooks were about to engineer, called Pearl Harbor, to “convince” a naïve American public that millions needed to die in yet another contrived world war.]

In 1944, Johnson arranged a press conference and let it slip that he would announce publicly the clinical results and that the cure for cancer had been found. There are allegations that Johnson had already been approached by “representatives of the pharmaceutical

industry” who offered him money to suppress information about Rife's work. Supposedly he refused. He had also certainly been pressured by Fishbein.

The night before the press conference, however, Johnson died suddenly and mysteriously and all his notes were pronounced as “lost” by the executors of his estate. His death was recorded as “accidental death” although I have no details. There are claims that his body was later exhumed by FBI investigators who concluded that he had been murdered by poison.

Dr. Arthur Kendall, one of Rife's most prestigious and influential supporters, suddenly accepted an unprecedented pension of \$250,000 to retire to Mexico, and effectively disappeared from the scene. George Dock, another of Rife's clinical team, and also highly respected and influential, also took a huge and unprecedented gratuity to retire early.

Many of Rife's supporters were convinced this was the work of drug companies who were anxious to suppress a technology that would make virtually all drug treatments obsolete.

Rife was hounded by the FDA and the AMA. He was unable to practice without official intervention, and continued a steady decline into alcoholism. This didn't stop him, however, trying to continue his research. In the early 1950s Rife teamed up with a man called John Crane, under the auspices of a new company (owned by Crane) called Life Labs, Inc.

Life Labs, Inc.

Here the record becomes confused again. Crane worked on the development of several new machines. One in particular was quite different; it used a pad which had to be placed in contact with the body. Crane claimed that he and Rife had developed the machine together, and Rife was certainly associated with the company because he wrote letters on its behalf. But apart from Crane's statement there is no direct evidence to suggest that Rife developed or endorsed the pad machine. Because of this there is some confusion as to what constitutes a real “Rife machine” because some people (particularly those selling such devices) claim the former

Table 2. Crane's List Of MOR Frequencies

Microorganism	Frequency (Hz)
Tetanus	120
Treponema	660
Gonorrhea	712
Staphylococci	728
Pneumococci	776
Streptothrix (fungus)	784
Streptococci	880
Typhoid Bacteria	712
Typhoid Virus	1862
Bacillus Coli Rod Form	800
Bacillus Coli Virus	1552
Tuberculosis Rod Form	803
Tuberculosis Virus	1552
	(same as B-Coli)
Sarcoma (all forms)	2008
Carcinoma (all forms)	2128

and others the latter.

Users claim both are effective, but the original plasma device has the advantage that it can be used to treat the whole body, or even several bodies at once, since it has an effective operating radius of around 20 to 30 feet, depending on power level, and does not require any body contact.

Modern researchers who made contact with Crane studied circuit diagrams that Crane gave them and concluded that not only could the circuits not work as they were, but Crane did not seem to know very much about electronics. However, some of the circuits did work with minor modifications, indicating that Crane had probably taken the diagrams from prototype notes of other engineers who had worked for him.

Crane's involvement led to a second source of confusion. Crane published lists of MOR frequencies which were all in the low audio range. Clearly there was a big difference between Crane's frequencies and Rife's.

A popular list of frequencies (Table 2) which was obtained from Dr. Robert P. Stafford M.D., who is claimed to have used a “Rife machine” (probably a “Crane machine”) for clinical trials between 1957 and 1963 and which is often advertised as Rife's original frequency list, is in fact a copy of a document he received from Crane.

Interestingly, these frequencies have been claimed to be effective for Rife-type plasma machines by modern

researchers, but they are obviously not Rife's original frequencies.

[Editor's note: From a technical point of view, confusion is unavoidable here because most (if not all) of the researchers likely were unaware that a multiplicity of electromagnetic healing modalities were at work.]

A simple analogy would be that a researcher gives some patients a glass of "elixir" every day at noon while they're sitting out on a patio. The people get better, so the researcher ascribes success to the elixir—completely unaware that sitting out in the sunlight was a crucial component (if not the major component) to the recovery.]

In 1971 Rife was admitted to the hospital. Details are unclear, but I've seen accounts that attributed it either to a car accident or an alcoholic binge. Either way, it is reported that he died following accidental injection of a massive overdose of Valium.

The Lost Technology

Following his death, Rife's work was forgotten. Most of his original notes had been lost in the fires and/or supposedly destroyed by AMA/FDA agents. But some of his associates remained alive, particularly Crane, who wrote a book about the work (supposedly very long-winded and not very technically accurate according to those who have read it).

Crane was arrested numerous times for promoting Rife's work, and spent three years in prison for it. And there were still a few old doctors who claimed to have been successfully using the device for treatments (mostly in secret) over the years, and still had working machines.

Even Rife's microscopes were forgotten, except for odd articles of historic interest. For example, a 1944 report from the board of the Smithsonian Museum stated basically that the microscope worked and that Rife's results had been validated. The author, Dr. Raymond Seidel, reportedly survived a subsequent assassination attempt in 1945, after which he refused to mention Rife ever again.

An original Rife microscope (which, however, had probably been tampered with by Hoyland) resides today in the Science Museum in London, unfortunately broken and not on display. The microscope was formerly used at the London School of Tropical Medicine, but following a dispute between Dr. Gonin, the British doctor who used it, and Beam Rays Inc. (probably Hoyland), the machine was supposedly smashed by a mysterious man who arrived from America. It was later donated to the Science Museum by Dr. Gonin's family after his death.

Even the newspaper reports were hard to come by. Some of the newspapers told researchers that they had lost the specific editions with reports of Rife's work. (Note: only those editions!) Luckily there were people who did still have copies.

Modern Revival

The whole matter was revived suddenly around 1986. As far as I know, the recent efforts appeared after a book about Rife called *The Cancer Cure That Worked* was written by an author called Barry Lynes.

[Editor's note: According to the book

cover, it was "written by Barry Lynes with John Crane". Barry also has a new (2002) book called The Cancer Conspiracy: Betrayal, Collusion, And The Suppression Of Alternative Cancer Treatments. There's a lot of related information at his barrylynes.com website.]

Whatever the cause, several modern researchers tried to build duplicates of the original Beam-Ray devices. Most of them succeeding in producing allegedly bioactive machines, but none of them were truly original.

Eventually these modern researchers managed to make contact with the few surviving doctors who had worked with Rife and his machine, and slowly the details began to emerge.

Although Rife had used a variable carrier wave in his original prototype machine, later models of the machine used by other doctors used fixed carriers with amplitude modulation. It is not known whether these machines were Rife's, Hoyland's, or Crane's.

The modulation was a square-wave pulse with fast rise-time. Calibration and measurement of dial settings on the old machines revealed that the active frequencies of modulation were all in the low audio range, corresponding to the lists published by Crane.

One explanation of the discrepancy between Rife's original notes and the derived frequencies may be explained in terms of harmonics. The higher harmonics of a square wave pulse represent odd multiples of the fundamental frequency (Fourier's theorem) and so the square wave produces a range of different (higher) frequencies for any given fundamental frequency.

[Editor's note: For you more technical readers, the above is partially correct and illustrates the confusion, noted earlier, that's so easily generated over this subject. And the shorter the pulse, the more complete is the array of other frequencies produced in addition to the fundamental (pulsing) frequency.]

However, let's not get lost in details, and keep in mind that Rife was identifying mortal frequencies by subjecting his specimens to electromagnetic energies in a very particular beam pattern, and he did this WHILE watching the reaction on the specimen DIRECTLY through his special microscope. You can't do any more elegant "real-time" experiments than that! And it's questionable how many later researchers arrived at their mortal frequencies in so exact a manner.]

Another theory is that the

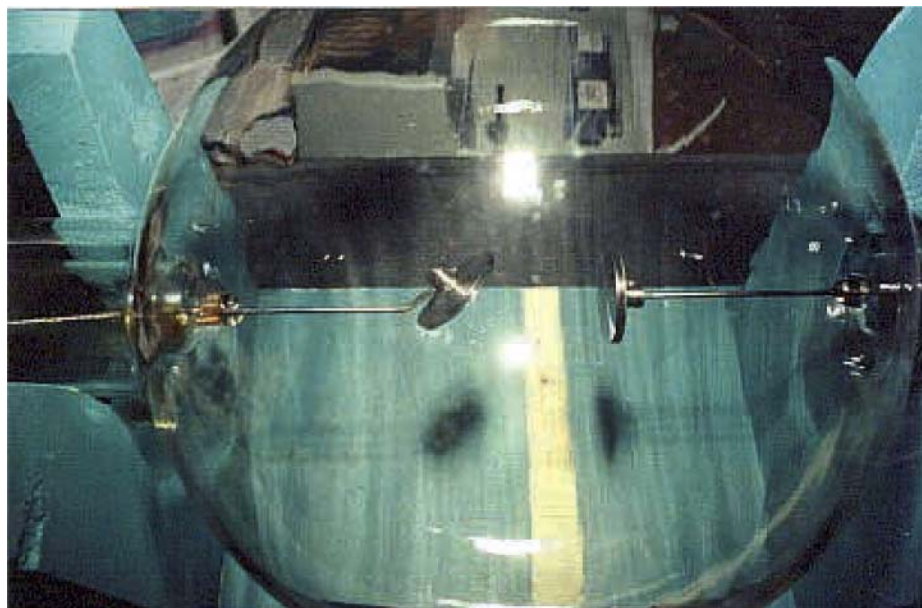

The large tube for the Rife Machine was made in Los Angeles.

microorganisms have more than one mortal frequency. There is some support for the latter idea in letters written by Johnson which indicate that, at one stage, he and Rife stumbled onto a "super-frequency" which would kill almost any microorganism. Unfortunately, this frequency was never recorded.

The modern researchers took various approaches to reproducing the machine. Some used old X-ray tubes filled with low-pressure helium or argon, others had tubes made, and some even made them themselves.

Bare Machine

One of the most popular recent incarnations of the Rife machine was developed by a Dr. James Bare. Bare took a minimalist approach to the problem and modified a CB transmitter and power amplifier to increase the bandwidth and to drive the tube at a carrier frequency around 27 MHz. Using the audio input of the transmitter to introduce the modulating pulses, he then proceeded to perform experiments to verify Rife's work.

I don't know exactly which experiments he did (I haven't read his book), but he claims that the device worked just as Rife described and he has had photomicrographs taken which allegedly show the device destroying single-celled organisms like *Blepharisma*. You can download a *Windows AVI* video file showing the process via the Internet (address at the end of the article). Bare also sells videos of other experiments.

The book of Lynes, and the work of Bare and others, caused a virtual explosion of activity in this field. Today, it is estimated that nearly 5000 people have Rife machines (or at least modern equivalents) in active use, and an enormous amount of anecdotal data has been compiled through amateur efforts to cure specific diseases. Although many of the anecdotes are purely subjective, a great many claim to have been verified by doctors, and some contain considerable clinical detail.

It is not unusual to see comments in which users have stated definite biometric measurements of their own diseases, both before and after treatment with the device. One thing is overwhelmingly clear: a large number of people are convinced that the devices work. Fantastic as it may seem, many people claim to have experienced improvements in cases of the most dire diseases, such as cancer and even AIDS.

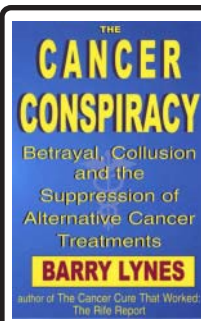

THE CANCER CONSPIRACY BY BARRY LYNES

Few people are aware of the deep criminal activities by organized medicine, top university medical researchers, drug companies, and high-ranking government "health" officials which perpetuated the crisis that gave birth to the grassroots demands for choice in healthcare. In his latest book, *Cancer Conspiracy*, world reknown Rife Energy Medicine researcher Barry Lynes describes in great detail the atrocious actions by those in power and the unapproved remedies and cures developed by Rife that have been suppressed for decades. It's time to learn the truth.

Available at: www.barrylynes.com

What is even more interesting is the number of people who have reported relief from the symptoms of diseases that are not known to have any viral or bacterial component, or the cause of which is still officially unknown. The devices have also allegedly been widely and successfully employed in veterinary practice as well, implying that the results are not simply due to the placebo effect.

Frequency Lists

As a result of all these efforts, there now exist a number of frequency lists (all freely available on the Internet) which give specific treatment frequencies for just about every disease imaginable. Others are classified by the micro-organism species.

Another interesting point worthy of note is that while Rife's original work only concentrated on MORs for bacteria and viruses (though he knew it affected yeasts, etc., as well), the modern

researchers claim to have found MORs for yeasts and molds, various protozoa-like amoebas, worms, and parasites like flukes, and even some insects.

The consensus seems to be that low frequencies are deadly to simple organisms. The more complex organisms like mammals (at first sight, see comments later) seem to be immune to these frequencies.

Side-Effects

Advocates of the machine are very prone to point out that there do not appear to be any negative side-effects (apart from the inevitable Jarisch-Herxheimer reactions), and so far nobody claims to have identified any bad or dangerous frequencies. My own feeling is that this is not strictly true and there is ample evidence of possibly bad frequencies. However, to someone dying of a terminal cancer, the risk is worth the potential reward.

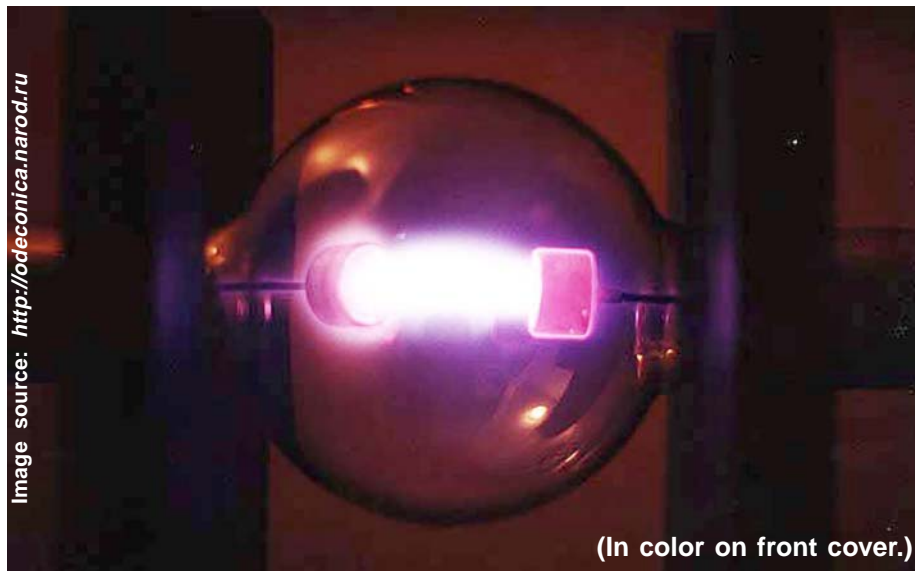

How It Works

By now you are no doubt longing to know how it works. The answer is that nobody knows for certain—although there are many clues to be found in modern research into the effects of electric and magnetic fields on biological systems. Unfortunately, this whole area of research still appears to be vehemently opposed by the mainstream medical establishment, and very little (compared to other fields of medical research) serious and rigorous research is being done.

At first sight it appears that the electromagnetic waves emitted by the plasma tube of the device are inducing fields or currents into body cells. However, many researchers are quick to point out that putting the device inside a Faraday Cage (which will block all electromagnetic waves) does not impair its effectiveness. Nor will a simple aerial produce the same effect.

Plasma Waves?

Some have speculated that the light from the tube is involved, but once again the device appears to work well with covered tubes. I have seen various theories that claim the existence of a

mysterious new type of energy, called a plasma wave, but my personal feeling is that this is too fanciful and there is a simpler explanation.

[Editor's note: The physics of Rife devices operates as much in the etheric as in the physical domain. This is what leads to so much of the present confusion because, figuratively speaking, ones are trying to deal with a three-dimensional object in flat, two-dimensional terms (of conventional science). Those who are familiar with Nikola Tesla's poorly (if at all) understood early 1900s research, involving the astonishing effects of very short pulses of electricity, may realize the important parallels to Rife's work.]

Patented HIV Cure

At this point I would like to digress to look at some other machines of a similar nature that may throw some more light on the puzzle before returning to the question of what is actually happening.

On 14 March 1991, two researchers, William Lyman and Steven Kaali, at the Albert Einstein School of Medicine, announced to the *First International Symposium On Combination Therapies* that they had found they were able to inactivate the HIV virus in blood

samples by passing a tiny electric current (less than 100 microamps) through the blood itself. A similar paper was published around the same time by a team in Japan.

The interesting thing here was that they didn't kill the virus; they just made it inert.

The virus reportedly was unable to penetrate and infect body cells after exposure. Either way, the result was more or less the same; it provided a clue to a potential cure.

The Einstein team were quick to file a patent (U.S. Patent 5,139,684) in which they described a hypothetical device which could be connected to the patient's circulatory system, and in which the blood would pass through a set of electrodes which would in turn pass a current through the blood, the "deactivated" blood being returned to the patient's body. Other researchers were also quick to confirm that the effect wasn't just limited to HIV; it worked just as well with other bacteria and viruses.

New-Age Devices?

This led to more amateur experimentation. A host of "new" machines emerged from various experimenters. I qualify the word "new" because all of them are just modern rehashes of the old 19th century electrotherapy machines. They basically fall into two main classes: those that pass a low-voltage alternating current through the body (ideally across some major artery) and supposedly purify the blood according to the Lyman/Kaali principle, and others that produce intense magnetic field pulses.

[Editor's note: The above description seems to overlook the most common variety of such electrical devices, which are commonly called "pulse boxes". They produce a low-voltage, low-current series of pulses which are conveyed—usually by two small electrodes at the ends of wires—to the skin above major surface arteries, like at the two wrists. The generated electric field thus penetrates and "cleans up" the blood circulating below the skin, in an arterial circuit, in a fashion similar to what the Albert Einstein School of Medicine team did, but without the blood needing to travel through any external plumbing.]

People who claimed to have tried these devices for the most part reported that they provided an amazingly rapid relief from symptoms. Of further interest was the fact that many people reported a consequent Jarisch-Herxheimer reaction. To put it simply, if you kill enough

How Can Electricity Help Restore Health?

Check The Beck Protocol ... A First-Aid Kit for the Future

The healing power of gentle currents of electricity was known in ancient Rome (electric fish) and was used extensively in spas and clinics before *The Medical Health Model* was established. Today *The Natural Health Model* recognizes the electrical nature of the body and the importance of working with the body's natural ability to heal itself.

The Beck Protocol offers a four-part program for health using micro-currents of electricity (Silver Pulser), pulsed magnetic fields (Magnetic Pulser), Ionic-Colloidal Silver and freshly Ozonated Water.



Robert (Bob) C. Beck, D.Sc.

1-800-224-0242

Tel: 250-770-2023 Fax: 250-770-1999
www.sotainstruments.com

PO Box 20019
Penticton, BC V2A 8K3



Snake-Oil And Snake-Bites

Vendors claim that these machines (which typically produce about 28 volts peak-to-peak a.c. square waves across the skin for the electric machines), and magnetic pulsers which work by discharging capacitors charged up to a few kilovolts into a magnetic coil, have no deleterious side-effects and are completely safe to use.

I am personally skeptical about most of the claims made for these devices and very much so about the safety of some of them. I believe that they do provide some of the symptomatic relief that they claim and not simply through a placebo effect. However, the long-term effect of using these machines has never been properly studied.

Some of these devices are supposed to be frequency dependent, others not. But as far as I can tell, the Rife machine still remains the clear winner.

None of these devices have been accepted by the mainstream medical establishment. However, many hospitals today use pulsed magnetic field therapy to speed up the healing of broken bones. This highlights the hypocrisy of some medical people who on one hand declare that there is no possible benefit to these kinds of therapies, yet happily use them to heal fractures.

[Editor's note: This author's skepticism of the efficacy of the electric-field and magnetic-field pulsers likely stems from a lack of familiarity with the sizeable body of medical research reporting sometimes astonishing findings utilizing electric currents and magnetic fields to assist healing. The clues are all over that literature—and thus make the hypocrisy noted above all the more glaring!]

As an interesting aside, there is a modern item of "bush-lore" widely accepted and used by travelers in certain parts of the world, and even endorsed by many doctors, that an excellent therapy for venomous snake bites is to apply a strong electric shock to the site of the bite, which apparently somehow neutralizes most snake venoms.

You can get manuals on how to perform an instant "bush cure" using the ignition coil of a car. It's supposed to work great for Rattlesnake bites.

Returning to the question of what is happening, I have frequently seen it suggested that electroporation, or voltage-dependent gating, may account for the effects of electric and magnetic fields on bacteria. I don't believe this to be the case and I think these ideas arise from an inadequate understanding of cell structure. To explain, let's start by looking at cells.

Bacterial, plant, and yeast cells are very different from the kind of cells found in the human (or other animal) body. Pathogens like the ones listed earlier tend to have a thick cell wall and an internal cell membrane that encloses

Voltage-Dependent Gating (VDG) is a different effect in which a protein molecule just a bit longer than the width of a cell membrane, typically helical in shape, tends to burrow its way through the cell membrane literally like a corkscrew. This creates what is known as an ion bridge and, under the influence of an electric potential, the ion bridge turns on like a switch and carries ions across the cell membrane. This mechanism occurs in many biological subsystems, most noticeably nerve cells.

The theory I have seen advanced for the operation of the Rife machine is that one or both of these effects results in an ion imbalance in the bacterial cell (but not the body cell) which results in an osmotic pressure differential that ultimately causes the bacterium to blow up like a balloon and then explode.

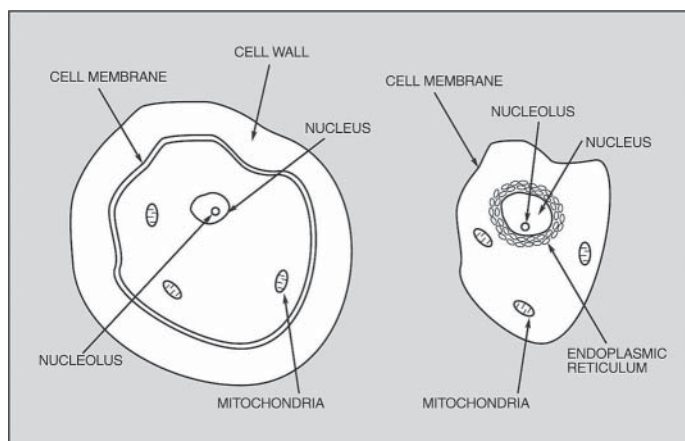

Fig.4. A bacterial/mold/plant cell (left), and (right) an animal cell.

them. There is a major distinction between the cell wall and the cell membrane. The cell wall is typically about 200nm thick, and the cell membrane usually consists of a layer of two protein molecules bonded together and is about 5nm to 10nm thick, depending on which protein is involved.

A typical body cell does not have the cell wall, it only has the cell membrane. Simply put, a bacterium or fungal cell has a coating many times thicker and stronger than a body cell. See Figure 4.

Electroporation, an effect often used by genetic engineers to introduce DNA strands into cells, occurs in cell membranes. Cell membranes have natural pores due to the statistical movement of the molecules that they are made of. The molecules move about, leaving momentary holes. If the movement of the molecules is increased by electrical stimulation, they tend to leave bigger (sometimes permanent) holes, and the cell membrane becomes more porous. A large enough hole will destroy the cell.

Balloons Versus Footballs

But the two effects above both operate on cell membranes (I don't know if they operate on cell walls), and so it follows logically that they are much more likely to damage a normal body cell than a pathogen.

To put it more simply, imagine a bacterial cell to be rather like a football, and a body cell to be rather like a child's balloon. If you blow air into both the football and the balloon at the same rate, the balloon is going to explode much more easily and much sooner than the football, because the football is thicker and stronger.

So this explanation is unlikely because observation supposedly shows the opposite to be happening.

New Theory

If the reports are to be believed, the real explanation must lie in some electrochemical property that cell walls have that cell membranes don't.

The answer may lie in what are known as ion exchange membranes (IEMs for short). The full technical explanation is too long and complex to reproduce here, but to simplify: a cell wall acts like an IEM; a cell membrane doesn't. An IEM promotes the exchange of ions either side of it when an electric potential is applied.

Simplistically speaking, I personally believe that the electric potential

induced across a cell wall by an external magnetic field (or local electric current) causes ion exchange across the cell wall, which results in profound changes in the chemical environment of the cell, for example pH (acidity/alkalinity).

Under the influence of such changes, the proteins that hold together both the cell walls and the cell membranes denature, depolarize, or lose their hydrogen bonding—i.e. they change shape from nice regular helixes into random strands. As such, they firstly lose their ability to properly participate in the chemical reactions that keep the cell alive and, secondly, result in the weakening of the cell wall which eventually ruptures and disintegrates.

This would explain both the Rife exploding bacteria effect and the Lyman/Kaali bacterial inactivation.

Mild denaturing of the cellular proteins will inactivate the pathogen's ability to bond to other cells or participate in chemical exchanges with body cells; a more pronounced denaturing will destroy the pathogen's cell wall.

I have greatly oversimplified this explanation because molecular electrochemistry is not an easy subject to master. I hope, however that I have conveyed a simplistic picture of what may be happening and why I have doubts about the more conventional explanations.

[Editor's note: A simplified rebuttal to this theory would point out that ionic movements like those suggested above are generally far too slow for the electromagnetic frequencies involved in Rife-like devices. It would be like a bowling ball on the deck of a boat that's being rocked back and forth very fast; above a certain "rocking frequency" the bowling ball more-or-less stands still because it can't respond fast enough to move in any one direction.]

A Cautionary Note

Having said all that, I must urge caution. While the mechanism of these electrotherapy devices may have a greater effect on bacteria, etc., than normal body cells, it would be a great mistake to assume that body cells are never damaged by these effects. Any body cell relies on an extremely complex system of electrochemical reactions to operate.

Clearly an electric, magnetic, or electromagnetic field applied close to the body will induce electrical potentials across cell membranes (and those of organelles) and will inevitably disrupt

normal body cellular electrochemical processes as well as those of bacteria.

Two real questions remain: firstly, whether these devices have any beneficial effect at all; and secondly, whether the gentler devices like the Rife Beam-Ray Machine (as opposed to something like the magnetic discharge machines) are really completely safe.

Of course, a degree of "collateral damage" may well be acceptable when you are treating a serious disease such as cancer. Undoubtedly existing traditional radiation and chemotherapy techniques which are commonly used to treat cancer (and even in some cases antibiotics) do cause serious "collateral damage" to normal body cells.

Another point to consider is that if you can kill a tumor cell by exploding a virus inside it, it follows that you can kill a normal cell the same way.

Up to this point I've been relating stories and theories secondhand. Now I'd like to just mention some experiments that I've done in this field. I would like to stress that I am giving this information for completeness and because it is interesting. I am not suggesting that anyone else should try this; it might be dangerous.

Subjective Experiment

As an experiment, I decided to try making a simple machine. Basically I designed a very simple magnetic pulse generator.

I made a simple driver circuit that accepts square-wave pulses from a TTL input and drives them at about 36 volts with a current capacity of up to four amps into a 35mH magnetic coil. The resulting magnetic field is quite intense.

I then hooked the machine up to a signal generator and tuned it to various known Crane MOR frequencies for common pathogens that most people have, and held the coil near to my body in various places.

Interestingly, I felt nothing at most frequencies, but got a noticeable reaction when I tuned to certain frequencies, for example 464 Hz, which turns out to be the MOR for *Candida Albicans* (a parasitic yeast that just about everybody has to some degree).

I was suffering from a gastric ulcer—i.e., gnawing pain under the ribs when my stomach was empty, bleeding, etc. I also have a hiatus hernia (weak stomach valve) which for many years has caused almost continuous indigestion and acid burning.

I normally have to take antacids every couple of hours, and certainly after every

meal. Having had no results from any conventional therapy in the past, I figured I had nothing to lose by trying the machine. I tried setting the machine to 676 Hz, the modern MOR frequency for *Helicobacter Pylori*, which is the usual cause of ulcers.

After about three minutes exposure at 676 Hz I felt a bit dizzy. About an hour later I had a particularly bad attack of acid and pain which lasted for about two hours. But next morning when I woke up, the usual pain under the ribs was much less. Later that day I tried again, this time two six-minute exposures, one at 676 Hz and the other at 464Hz (the *Candida* frequency).

I discovered that 676 Hz makes me feel dizzy and 464 Hz gives me stomach gas. This time I got a much smaller attack of pain, but also this time I got a spate of red blotches on the skin followed by itching all over, again lasting for about two hours. I figured the first was a Jarisch-Herxheimer reaction to the 676 Hz, and the second the reaction to the 464 Hz.

The next day, I woke up again with hardly any pain at all. During the whole day I only had to take one antacid tablet, which is unprecedented. After four days of similar treatments, all pain had gone and I was getting no detectable reaction at all to either of the frequencies. What is more important, I had no indigestion for the first time in years and there was no more bleeding. I stopped the treatments at that point.

At the time of this writing, it is now nearly three months since I performed this experiment. I have had no pain, no bleeding, and feel better than I have in years.

A few weeks ago, I got the symptoms of a mild cold for a couple of days. The indigestion returned for a day, although not as badly as before. I tried the machine again, tuning randomly through various frequencies and looking for reactions. I got strong reactions at frequencies which I later discovered were known MORs for Adenovirus (a common respiratory infection) and also *Chlamydia Pneumonia* (also a respiratory pathogen). Two days of treatment, as before, at the new frequencies, has once again removed all symptoms and the indigestion is gone.

Placebo Effect?

It's not very scientific, but I'm convinced it works. If anything, it has convinced me that this whole field is too important to ignore, and the more serious research and experimentation that is

done, the better.

Skeptics will, of course, argue that this is a classic placebo effect. But having tried various remedies over the years without anything like these results, I believe otherwise.

I also tried a further experiment with molds. I took a piece of bread, dampened it, and left it out overnight. I then broke the bread into two similar pieces and put each piece in a separate, sealed, sterile container. I took one container and exposed it to a range of different antimold frequencies of the magnetic pulser. The first container was left untouched.

After four days, the containers were compared. The first, untouched container was full of mold; the second was completely clear. Since the only difference between the two was the exposure to the magnetic pulser, I concluded that the magnetic pulser had killed all the mold spores in the second container.

Pulser Circuit

For anyone interested in doing further experiments, the circuit diagram of a second, very simple prototype of my pulser is shown in Figure 5. The input is a simple TTL square wave at the frequency of interest. The circuit consists of two simple buffer/

inverter stages, around transistors TR1 and TR2, to translate the TTL signal into a larger voltage swing to drive the two parallel MOSFETs in the output stage, shown combined as TR3, into hard conduction.

The MOSFETs are wired in parallel to increase their current capability and mounted on a big heat-sink, although they have a very low on-resistance and so the dissipation of the circuit is low. The 20-Volt Zener diode, D1, wired from the drain to gate of the MOSFETs, prevents inductive voltage overshoot and gives the MOSFETs a very hard switch-off edge, which is supposed to be ideal for bioactive effect.

The power supply is a simple 21-Volt unregulated supply (a rectified 15V a.c. transformer with a 4700pF smoothing capacitor) but which needs to have a high surge capacity as the transients generated by the coil can overload the transformer and rectifier.

The second prototype uses a 200 VA transformer and 10 A rectifier, which works well. My first prototype used only a 100 VA transformer and died suddenly

in a cloud of smoke!

The coil, L1, consists of approximately 333 turns of 22-gauge enameled wire wound on a plastic form of about 13 cm diameter (a standard plastic waste-pipe coupler) in eight layers, across a span of about 25 mm. The turns of the coil need to be tightly wound and well varnished into place to prevent oscillation and heating in operation. The prototype coil gets mildly warm in normal use, about 40°C.

Do Not Try This At Home

Again I urge everyone to take care. I only experiment on myself. The cardinal

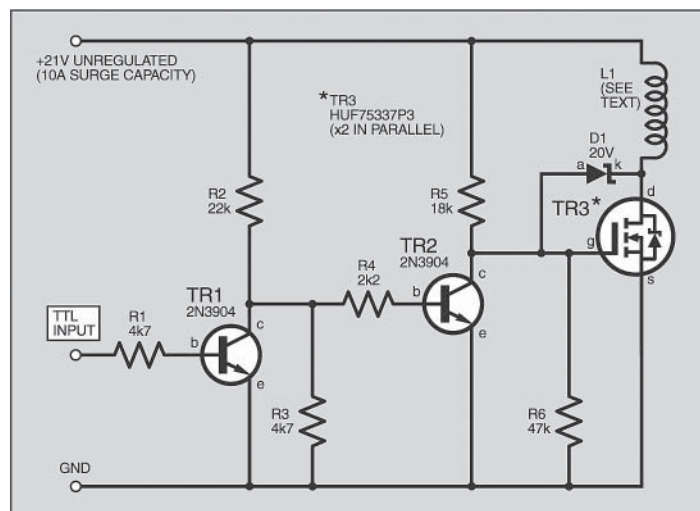

Fig. 5. The author's experimental pulser circuit.

rule for me is: don't try to treat anybody else. I am aware of the risks I take and accept them; other people may not be. I also don't encourage anyone to try this on themselves, but only to perform proper experiments with microorganism samples with due precautions under scientific conditions. There is still too much that is not properly understood about this technology.

I personally believe that the Rife-type plasma machine is the safer option. However, these machines are difficult to obtain and very overpriced (ready-built). I have asked a few manufacturers for specs, but I've found that many are unwilling to give proper specifications, and in some cases the advertising claims are simply untrue.

If there are any decent r.f. engineers out there (high-power r.f. design is not my specialty) I for one would be interested in a modern design for a Rife plasma device built from the ground up and optimized, not just based on modified CB radios. It should also work with lower carrier frequencies, as there is some evidence that carriers in the range of 3 MHz to 11

MHz are more effective than the 27 MHz CB range.

Currently, I am working on the design of a high-accuracy digital frequency synthesizer that I intend to use for further experiments.

I must add that, despite my opinions, I am not specifically endorsing any of these devices in any way. I am only presenting this information as a matter of interest.

Other Evidence

Among the scientific literature, I have discovered there is a wealth of information as yet not properly compiled together, and usually buried in incomprehensible technical gibberish. I have seen research reports which indicate that weak magnetic field pulses at 16.7 Hz can stimulate the body into increased production of T-lymphocytes. I have seen other reports that indicate that other frequencies inhibit the same lymphocytes.

There are also reports that claim similar effects at various frequencies that inhibit cancer cell growth and ones that stimulate it. Most of the current research, however, has focused on the effect of power-line frequencies (50/60 Hz). Most reports indicate that

these frequencies are dangerous; I have not seen any evidence of any beneficial effects reported at these frequencies.

One thing that does seem to be confirmed repeatedly by research is that weak electric and particularly magnetic fields have a most profound effect on growing cells. The faster the rate of cell growth, the more pronounced the effect. This implies that any low-frequency magnetic field may be particularly dangerous to children, and especially to unborn children. Also, prolonged exposure to any low-frequency magnetic field may cause VDG and/or electroporation and consequent cellular damage.

It is now widely accepted by many researchers that any field in excess of 150nT is likely to have an immediate bioactive effect on cellular metabolism, and much weaker fields may have effects after a longer exposure.

Official Recommendations

Despite numerous well-founded and intensive research studies on the

bioactive effects of low-frequency electric and magnetic fields, both the U.K. NRPB (National Radiological Protection Board) and the U.S. NCRP (National Committee on Radiation Protection) insist that their official position is that there is no proven risk of adverse health effects from low-frequency fields.

Many informed observers believe that this is a short-sighted view motivated by political considerations. For example, both authorities have close ties to power generation companies that obviously would be reluctant to admit that their product might be dangerous to consumers.

In the United States, at least, this has led to conflict between various government agencies. For example, the NCRP and the EPA (Environmental Protection Agency). The EPA has allegedly petitioned various U.S. government authorities to classify low-frequency radiation as "a possible human carcinogen", but has met with concerted resistance from the power companies and their lobbyists. In addition, numerous lawsuits have been filed by consumers and environmental groups against power generation companies, citing research and statistical studies that supposedly show a strong correlation between childhood leukemia and proximity to power lines emitting low-frequency electric and magnetic fields.

The fact remains that while these authorities insist there is no proven risk from low-frequency fields, they are talking in the context of normal domestic power lines, and on the basis of projected field strengths and exposures in normal use. Neither authority is actively denying

that low-frequency fields have bioactive effects per se, although there is controversy over the field strengths that might have an effect, and whether or not the effects are temporary or permanent.

The NRPB in the U.K. has published reports in which it admits that some strong low-frequency fields might have temporary bioactive effects. The NCRP is also at the center of a controversy over a "leaked" internal draft recommendation of 1995 by its own research teams which makes various recommendations, citing specific bioactive effects of low-intensity low-frequency fields and which concludes:

"Based on available evidence, the committee concludes that it is desirable to reduce human exposure to electric and particularly to magnetic fields over the frequency range from near zero to 3kHz. This may be accomplished, particularly in areas with frequent and prolonged human occupancy, by recommending an exposure standard, or a set of safety guidelines, or by recommendations that fall short of establishing either a standard or guideline, but offer guidance to limit exposure."

Food Preservation

Perhaps the most interesting twist to the whole story comes in the form of two new reports by the U.S. FDA, the very organization that tried to shut down Rife. These latest two reports consider the use of pulsed electric and magnetic fields for food preservation on the basis that accepted research shows that pulsed electric and magnetic fields can kill bacteria, viruses, and other pathogens.

These two reports (which are available

on the Internet, addresses later) cite impressive figures for kill rates of specific bacteria at specific pulse rates of a strong magnetic field. But the conclusion of the reports is that pulsed fields do not qualify for approval as a method of food preservation because the mechanism of action is unknown, and also because of inconsistent results; in some cases the fields appear to enhance the action of bacteria, in others they kill them, and some appear to have no effect at all.

The interesting conclusion the FDA draws from this is that the effect is obviously frequency dependent and also is influenced by field strength, exposure time, and the nature of the material exposed. This is almost exactly what Rife was saying in the first place.

Magnetic Field Report

Here is an extract from the FDA magnetic field report:

"Exposure to a magnetic field may stimulate or inhibit the growth and reproduction of microorganisms. A single pulse of intensity of 5 T to 50 T and frequency of 5 kHz to 500 kHz generally reduces the number of microorganisms by at least 2-log cycles (Hoffman, 1985). High-intensity magnetic fields can affect membrane fluidity and other properties of cells (Frankel and Liburdy 1995). Inconsistent results of other inactivation studies, however, make it impossible to clearly state the microbial inactivation efficiency of a magnetic field or to make any predictions about its effects on microbial populations."

Finally

I have deliberately tried to keep this article simple, trying to find a balance between completeness, common sense, and scientific overkill. I hope that I have at least stimulated some readers to research this fascinating subject themselves.

Acknowledgement

Photographs of the 1947 Rife machine were downloaded from the www.rt66.com/-rifetech/rife.html website and reproduced by kind permission of James Bare.

References

Ions, Electrodes, And Membranes
J. Koryta. 1992. John Wiley and Sons, ISBN 0-47193080-6. A good introductory book on cellular electrochemistry.
www.lvstrings.com/quack.htm
Jeff Behary's Turn of the Century

...and the truth shall set you free

David Icke exposes the real story behind global events which shape the future of human existence and the world we leave our children. Fearlessly, he lifts the veil on an astonishing web of interconnected manipulation to reveal that the same few people, secret societies, and organizations control the daily direction of our lives. They engineer the wars, violent revolutions, terrorist outrages, and political assassinations; they control the world market in hard drugs and the media indoctrination machine. Every global negative event of the 20th Century, and earlier, can be traced back to the same Global Elite, and some of the names involved are very well known. Never before has this web, its personnel, and methods been revealed in such a detailed and devastating fashion.

Icke reveals the esoteric background to the

global conspiracy and offers an inspiring spiritual solution in which every man, woman, and child on planet Earth breaks free from the daily programming—the "coup d'état on the human mind"—and takes back their infinite power to think for themselves and decide their own destiny. His words are designed to inspire all of us to fling open the door of the mental prison we build for ourselves, and to walk into the light of freedom.

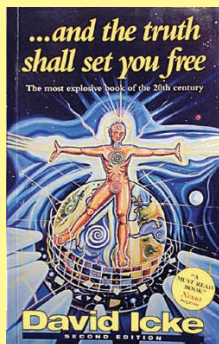

\$24.95 (+ S/H)
Code: TSSF (1.5 lb.)

OVER 500 PAGES

SEE NEXT-TO-LAST PAGE FOR ORDERING OR CALL TOLL-FREE: 1-877-280-2866

Electrotherapy Museum. A wonderful site with descriptions and many photos of the plethora of extremely weird, wonderful, and hilarious early electrotherapy devices.

www.mtn.org/~quack

Another wonderful on-line "quackery" museum with links to many sites.

www.rife.org

Site of the *Rife Plasma Digest*, a very good site with scanned copies of numerous original Rife documents and correspondence.

www.rt66.com/~rifetech

James Bare's website; lots of information and great links. Check out the AVI video of the exploding Blepharisma!

www.rife.de

The *Rife Information Forum—Europe*, useful links and information about clinical trials.

http://patent.womplex.ibm.com/details?patent_number=5139684

A link with details of the Einstein team's patent for their proposed HIV treatment with details of numerous subsequent similar patents.

<http://vm.cfsan.fda.gov/~comm/ift-omf.html>

FDA report (2000) on use of pulsed magnetic fields for food preservation.

<http://vm.cfsan.fda.gov/~comm/ift-pef.html>

FDA report (2000) on use of pulsed electric fields for food preservation.

www.nrpb.org.uk

The official web page of the U.K. National Radiological Protection Board (NRPB).

www.ncrp.com

The official web page of the U.S. National Committee on Radiological Protection (NCRP).

www.microwavenews.com/ncrp.html

A link to a copy of the "leaked" 1995 NCRP draft recommendations for low-frequency field exposures.

* * *

Editor's note: The following comments by the author of the above April 2001 Everyday Practical Electronics article were written a month later in response to a lively array of feedback he received.

Comments By Aubrey Scoon

I've received numerous responses regarding my article in the April [2001] edition of *Everyday Practical Electronics* (www.epemag.wimborne.co.uk).

It appears that some people have misread parts of the article or jumped to conclusions about what they think I

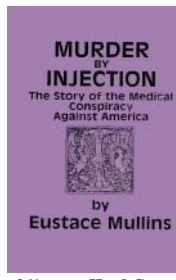

MURDER BY INJECTION
The Story of the Medical Conspiracy Against America
by Eustace Mullins
361 pages Hard-Cover

MURDER BY INJECTION

THE STORY OF THE MEDICAL CONSPIRACY AGAINST AMERICA

This classic by Eustace Mullins unveils the Conspiracy to deny you low-cost alternative healthcare and how federal agents commit acts of "Criminal Syndicalism" to protect the profits of the "Drug Trust". The world's 18 largest drug firms are listed. Some of the topics covered are: Profits of Cancer, AIDS, Contamination of the Food Supply, Death and Vaccination, The Rockefeller Syndicate.

\$20.00 (+S/H)
Code: MBI (1.5 lb.)

SEE NEXT-TO-LAST PAGE FOR ORDERING OR CALL TOLL-FREE: 1-877-280-2866

meant as opposed to what I actually said! So I'd just like to clear up a few points that have been misinterpreted.

Firstly the circuit described in the article is for a simple magnetic pulse device. It is NOT a Rife device and I have never made any claim to that effect. The only association with Rife's work is the fact that I personally tried it with Crane frequencies that have been (probably wrongly) attributed to Rife. The article is designed to throw some light on several aspects of electrotherapy. While Rife is the main focus of the article, it is not exclusively about Rife, so the fact that various devices are mentioned does not imply that they are all forms of Rife devices or that they have anything to do with Rife.

The reason I decided to try a magnetic pulse device was to test an initial theory of my own that it was the magnetic field from the Rife ray device that was responsible for the bactericidal effect. I have since found that I can duplicate the effect with pure electric fields, magnetic fields, and even infra-red light. I haven't tried electromagnetic fields. All the pure scientific research I have seen indicates that normal EM fields (i.e. radio waves) do NOT (in general, there are exceptions) exhibit the Rife effect.

So to all the people who have commented to the effect that my circuit doesn't produce EM fields or is an inefficient EM transmitter: it is NOT an EM transmitter; it's just a crude prototype designed to create pulses of magnetic flux, nothing else.

As for the coil mentioned in the article, the one described measures an inductance of 931uH. The 35mH coil referred to was a first prototype, the construction of which is not described in the article. As I did mention in the article, the circuit described is for my SECOND prototype, which was much simpler and more efficient than the first.

Some readers have asked me for therapeutic recommendations for the magnetic pulse device. I mentioned clearly in the article that I am NOT recommending medical treatment with

this pulser. It was not designed as a proper therapeutic tool. It was meant to confirm some crude experimental results. I have no idea of what the longterm effects of exposure to pulsed magnetic fields might be and recommend that anyone who wants to experiment with this should do so with extreme caution. If you want to see if the Rife effect works, try it on a sample of mold or bacteria in a culture dish; don't go around trying to cure people with it. If you want to try it on yourself, that's up to you; but I didn't tell you to do it!

I did not comment anywhere in the article that I recommended this kind of treatment and that I thought it was unconditionally safe. On the contrary, I clearly stated that I thought it could potentially be very dangerous. I did mention that other people had claimed it was safe; but I didn't make that claim myself. There are many different forms of electrotherapy and many different kinds of devices. Each should be independently assessed and treated on its own merits, something I didn't try to do in my article.

A few readers have commented that the super-regeneration wavelengths quoted from Rife's papers are higher frequencies than the carriers. This is true, but one should not literally accept that an original Rife machine consisted of a simple modulated carrier. In fact, the little information that does exist about those original machines indicates that they may have been more like mixers than simple modulators. I believe I now know the significance of the "super-regeneration" aspect of Rife's original machine and intend to expand on that in a forthcoming follow-up article.

With regard to how the Rife effect works, I believe that magnetic and electric fields are inducing electrochemical changes in cell membranes which affect electrochemical pumping mechanisms. In particular I believe that the Rife-type machines interfere with proton pumps that are fundamental to the operation of bacterial cells, but which are not present in animal cells. I have no idea how the

Rife effect works on viruses, and as yet I don't even have the basis of any theory because viruses are very different to animal-bacterial cells. I am working on an expanded theory that may account for how infra-red pulses can produce the effect by photoelectrochemical absorbance, but I would like to clarify that I do not endorse the view that the Rife effect is due to mechanical resonance. Rife thought it might be, but I didn't say I agreed with that idea!

I do encourage readers to do their own research. Look at proper published scientific research papers; don't just accept what you read on some website or book or advertisement (or even magazine article!) either for or against. The only way to find the truth is to look for it yourself, with an open mind.

Some people have commented that the only correct way to approach this is with skeptical thinking, but there is a flaw in that because a skeptic—in my definition at least—is someone who refuses to believe the facts before them unless they can be made to fit an accepted, conventional theory. But the facts are the facts; the theory needs to be modified to fit the facts, not the other way around! Unconditional belief is just as bad because, despite the best intentions of some of the “distributors”, a lot of the material that one reads about Rife, etc., on places like the web is unresearched and in many cases just plain wrong. But you can read from some of Rife's original papers; you can find proper scientific research papers; and finally, best of all, you can do your own experiments and see it for yourself.

You can do historical research too. The full story is a lot more interesting than just my brief description. You can find information on the people mentioned and events referred to. Look it up and decide

for yourself what is true or not.

I recommend that readers read Barry Lynes' book, look at James Bare's experiments, the reports on Peter Walker's Rife Information Website, and also check out the recently available reproductions of audio tapes and video films of Rife himself talking about his work. But don't stop there; keep looking!

The true spirit of scientific method is to investigate something with no preconceived ideas about whether it's right or wrong. It involves simply looking at the facts, checking and verifying them, and then formulating a theory to fit them. The moment one makes any assumption, either way, the scientific method has been lost. The same applies if you discard any facts you don't like or introduce unverified information as fact. The fundamental reason why such a promising field of research is still in its infancy is simply because many people are more concerned with forming themselves into opposing camps of skeptics and believers than with simply looking for the truth for themselves.

[Editor's note: Well, even though it's not the FUNDAMENTAL reason by a longshot, he's certainly correct to imply that a lot more progress will come from working together in honest inquiry than from extremes of “blind belief” that lead to fighting. After all, those crooks in high secret places who have long worked to derail such advancements as electro-medicine have always found that well-placed skeptics can keep a field in a turmoil, chasing its tail rather than getting anywhere productive. It's time to rise above being so easily hoodwinked by such baited trickery.]

I have a couple of personal rules of thumb that are not strictly in accordance with the true spirit of scientific enquiry but may be valuable in general. Firstly, if

someone is trying to sell you something, then any information offered in support of their product should be treated with the utmost suspicion unless it can be independently verified. Secondly, if anyone quotes a dozen pages of their professional qualifications in support of their pet theory, whether for or against, that should also be viewed with suspicion, because facts speak for themselves; they don't need qualifications, accreditations, certifications, and accolades to be facts.

Anyone who needs to do this to promote their ideas probably has a very weak case, because facts should stand on their own merits.

[end quoting]

In light of the above astonishing information, is it really any stretch to imagine that the major pharmaceuticals (and their AMA and FDA puppets) would go to any lengths of immorality to suppress such cheap electromagnetic alternatives to an otherwise lucrative business?

Royal Rife Comment

Not long before he became ill, Dr. Rife made the following profound (under)statement:

[quoting]

I hope I have helped humanity some. I am just an ordinary man, doing the best he can.

We are all here to do our part. Each has a purpose as he lives it and thinks it. We need religion to balance scientific discovery, and the material and the spiritual must go side-by-side.

Religion guides scientific discoveries. Religion is a stabilizer. I sincerely think and believe that our Good Lord helps us in many ways to accomplish our desires. This has been proven in many cases where results obtained were from none other than our Almighty God.

The most important thing I ever did was build a microscope. The things I've done have possibly [!!!] helped humanity. I have tried to create and develop things for the good of the Universe. I am grateful to God that he has allowed me to do the things I have done.

[end quoting]

Is it any wonder why Dr. Rife was chosen to bring forth a gift of such vast good for humanity? But what a threat to the world controllers! And their suppression tactics continue to this day, which brings us to our next topic.

Now that we have an understanding of why Rife's discoveries and equipment represent such a threat to the modern medical-business establishment and the

HEALING CODES FOR THE BIOLOGICAL APOCALYPSE

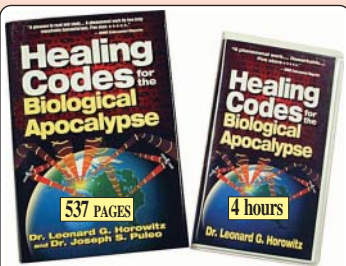

Hard Cover Book:
\$26.95 (+S/H)
Code: HCBA (2.5 lb.)

Audio Tapes:
\$29.95 (+S/H)
Code: HCBA (0.5 lb.)

One half of the world's current population should soon be dead according to authoritative projections. Will you, your family, and friends be among the survivors or the deceased?

Dr. Len Horowitz and Dr. Joseph S. Puleo investigate 2000 years of religious and political persecution and the latest technologies being used to enslave, coerce, and even kill billions of unsuspecting people.

This work returns the most precious spiritual knowledge and “healing codes” to humanity. It offers hope for the loving masses to survive the worldwide plagues, famines, and weather changes that are now at hand. *Healing Codes*

presents an urgent, monumental, and inspired work that will be hailed for generations to come.

SEE NEXT-TO-LAST PAGE FOR INFORMATION OR CALL TOLL-FREE: 1-877-280-2866

pharmaceutical cartels, we're going to examine the matter of a recent FDA raid on the home of Jim Folsom in San Diego. (He's the author of the quote at the very top of this article.)

We'll begin with Jim's letter to the President and Congress:

[quoting]

Open Letter To
President George Bush & Congress

Re: Operation Health Freedom

(Editor's note: Though it's called Operation Health Freedom, their website is noted as www.othf.org—which means Operation Total Health Freedom.)

This past March you launched Operation Iraqi Freedom. I commend you on your desire for freedom for the Iraqi people. This great endeavor and the success of the American military men and women serving under you is most commendable.

On July 4, 2003, We-The-People of the United States of America are launching "Operation Health Freedom". We are calling upon you as the President of the United States to join us in this great undertaking. We are calling upon our Representatives in Congress to join in also.

Also, We-The-People and Citizens choose July 4th for a New Declaration Of Independence and A New Era Of Freedom for the People of the United States of America.

On April 2nd of this year, while American soldiers and marines began incursions into Baghdad for the liberation of Iraqi men, women, and children from an oppressive dictatorship and a flawed oppressive governmental system, homes here in the United States of America came under attack, not by members of Saddam Hussein's Red Guard, but rather by U.S. Federal Agents from the FDA (Food & Drug Administration) and other Federal Police who are under your administrative authority. Our homes were forcefully invaded as we became **victims of fraudulent, "illegal/legal" actions, with clear violations of our civil and constitutional rights.** Without any charges of illegality our homes were searched, property seized, we were placed under intense interrogation (no Miranda rights presented), with intimidation of possible further economic loss (legal fees), and possible seizure of our homes. Yes, this in our free America, and at a time when we are "liberating" Iraq from oppressive tyranny.

One of these U.S. invaded and terrorized

DEATH IN THE AIR: GLOBALISM, TERRORISM & TOXIC WARFARE

This book explains how and why:

- We have evolved from the nuclear age into a "Technotronic Era" with "psychotronic warfare" for optimal population control.
- Non-lethal warfare is being effectively used to produce sociopolitical and economic outcomes consistent with global genocide.
- The world's wealthiest policy-makers have recommended, and are working toward, eliminating half the world's population.
- Accepted methods of disease prevention, such as pesticide sprayings, can only be scientifically rationalized as costly and deadly contributions to non-lethal warfare and population reduction.
- Chemtrail sprayings that obscure blue skies are not normal, but reflect a conspiracy of silence and military attacks on the health and welfare of people around the world.

Striking at the heart of those responsible for the latest forms of bio-terrorism, psychotronic warfare, and ecological genocide, the revelations contained in this book offer more than a reality check—they give you and your loved ones a final, last-minute choice for survival.

SEE NEXT-TO-LAST PAGE FOR ORDERING OR CALL TOLL-FREE: 1-877-280-2866

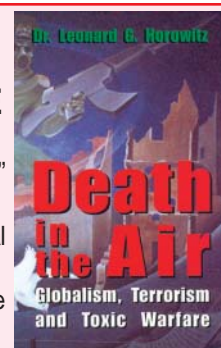

Hard Cover: \$29.95 (+S/H)
Code: DTA (2.5 lb.)

homes belongs to an honorably served U.S. Army veteran. One family experiencing this armed "terror attack" was a newly arrived Mexican family, one member with recent U.S. citizenship, and having come to the U.S. for better political and economic freedoms. Their part of the American dream has been shattered. Another experiencing this attack was a legal resident from Southeast Asia who came to the U.S. in order to be away from brutal police tactics that are often known in that part of the world. Her dream of a truly free America was severely shaken.

How does all this tie into Operation Health Freedom, which we are asking you, Mr. President, to join and even lead the way? Another great success for freedom, particularly for freedom here in America, will be a great tribute to your Presidency.

This terror attack on our homes was done on the pretext of "protecting" the health of American citizens. We believe it is only a pretext to protect and hold together an "old order" and "lagging edge" medical and pharmaceutical industry that all too fraudulently holds its economic power grip on the U.S. economy, the political processes, and most importantly the vital health and welfare of every citizen of America.

[Of course, with the well established Bush family ties to the Eli Lilly Pharmaceutical Company, it is likely that this request to the President will fall on deaf ears. — R.M.]

What are we saying here?

Example: The life expectancy of Americans is high, but is the quality of life—when our children are drugged to keep them "attentive" in school, our senior citizens drugged, kept numb, and partially alert until the "die-off" drug,

"pacified" in an old-age home or special-care facility? Industrialized Japan finds its citizens, both young and old, happy, healthy, and not loaded with drugs, who pass their senior years in a quality state of health and well-being.

Our American hospitals are among the most deadly infectious places on planet Earth. There are third-world countries more infection free than our hospitals, which have infection rates, leading to death, of over 100,000 citizens per year. This rate does not match the number of deaths caused annually by medical abuse, mis-diagnoses, and mis-application of drugs which, together with hospital infections, cause 270,000 deaths per year.

These drugs often cost \$100 or more per pill, and more often than not just "mask-over"—or at best "manage"—a symptom, not eliminate it; and another drug is used to mask-over the symptoms of the prior prescribed drug, and on and on this goes.

Hospitalization stays, often minimal at \$2,000 per day, are financially breaking all too many of our citizens. Medical insurance is too cost-prohibitive for most, and becoming costlier daily.

Are we surprised that medical costs are one of the greatest causes of bankruptcy here in America? Or, that the true healthy well-being of our people is not the best in the world?

We desire cost-effective health and wellness modalities that are not restricted and controlled by Federal bureaucratic tyranny, with its main purpose to hold the "old order" medical/pharmaceutical system in place. No, we no longer seek our salvation in more and costlier "research", expensive technologies, "miracle" surgeries, "wonder" drugs,

etc. The later is responsible for the “health crisis” in America and is placing us and our families at risk. We demand change for the better.

It is well known, the current “health” system in America is flawed and in crisis. We are calling upon you, Mr. President, Congressional Representatives, Federal, State, Local representatives and civil servants at all levels to join and assist in our endeavor Operation Health Freedom. There is a part each and every one of you can take.

For you, our Congressional Representatives, we are requesting that you personally demand a full and complete U.S. General Accounting Office investigation of the Food and Drug Administration which, under the guise of “protecting the health” of citizens, is all too often only protecting the “old order” and often doing so with blatant civil and constitutional violations of our citizens. We are requesting a full and complete Congressional investigation of the “health crisis” in America, an investigation into the money trails and the strings of influence. We believe a very flawed “old order”, lagging-edge, costly, entrenched system has been strongly in place for all too long.

We-the-American-people are paying the price for this in our health—physically, mentally, emotionally, spiritually, and economically, and we are demanding change. Not little change. A big change. Now.

I, the author of this letter, am a U.S. Army Veteran, having honorably served during the Vietnam era in a NATO missile command in Southern Europe. My lineage here in America is tenth generation, and those who came before

me are among those who helped build this country, fought for its freedoms, helped preserve and protect it in its battles and wars, and made it the great country that it is today.

Mr. President, those who walked before us in this great country would not be proud if they saw what happened with this terror invasion of our homes last week by armed U.S. Federal agents, with fraudulent “lawful” disregard for our civil and constitutional rights—actions which only the likes of Saddam or Hitler would truly be proud.

Mr. President, we are talking about agents under your direct authority. I have had FBI agents in my home assisting them in investigative matters and with them being aware and having in their files the business activities that I am involved with and represent.

I am demanding that, if I did anything in my business that is illegal, that I be legally charged accordingly, arrested, and provided my day in court.

Otherwise, I demand that all property, records, books, historical library, reports, etc., that were seized in these terror raids, be returned immediately and be returned in good order.

This is a text case for us here in America. Civil and constitutional rights violations and freedoms are only part of the issue. The troubling and overriding issue for the “health police” is the economic, low-cost technology that the American people are becoming aware of, finding affordable, effective, and are purchasing.

At issue is: Do we, as citizens of these United States of America, have the right to care for our own health and wellness, without having to rely upon the “old

order”, cost prohibitive, medical/pharmaceutical/governmental system that is in crisis? The recent armed Federal Police and FDA Agents’ terror attacks on our homes were a result of equipment used for experimental and investigative research that is often used in health clinics by N.D.s, Ph.D.s, M.D.s (often retired), D.C.s, Dentists, other “wellness” practitioners, and a broad spectrum of American citizens.

The historical records, results, and research of this technology spans most of the prior century.

As has happened in the past, your Federal Police and FDA agents today are making a continued effort of suppression and destruction of low-cost, cost-effective “alternative” health technologies and services. The trail of this conspiracy is vast.

Again, Mr. President, as this drama plays out, and that is exactly what it is, we-the-citizens of the United States of America are asking for your participation, along with the participation of others, and we are watching to see who is on our side in Operation Health Freedom.

We would like to know if we still have a government here in America that serves us, its citizens. Is this truly so?

We commend you for your desire to bring freedom to the Iraqi people. Are you willing to do the same for we-the-citizens of the United States of America?

We are requesting that you come aboard to assist us in this great cause for freedom. Yes, this is a great cause. It will not be easy. There are entrenched interests that are not about to let go easily. And yes, we are talking about freedom, here in America—freedom regarding basic physical health, economic health for us as individuals, and for the health and economic well-being of our families, all our families. This also involves freedom from fear of individual and family fortunes being wiped-out due to this tragic health system here in America.

Those seeking answers in the old system are not going to find answers to our health crisis; they are looking in the wrong direction. Just as you did not look to Saddam for freedom for the Iraqi people and provide him with billions upon billions of U.S. taxpayer dollars, we expect neither you, nor our Congressional Representatives, to receive much valuable assistance, answers, or results from the “old order” medical/pharmaceutical/governmental system currently in place. Nor do we desire seeing more and more billions thrown into this flawed system.

It is known that a majority of our citizens are seeking low-cost “alternative methods” for health and wellness and are

EMERGING VIRUSES - AIDS & EBOLA

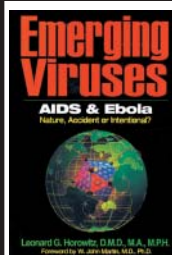

This is the first in-depth exploration into the origins of HIV and Ebola. Claims that these “emerging viruses” naturally evolved and then jumped species from ape to man seem grossly unfounded in light of the compelling evidence assembled in this extraordinary text. Alternatively, the possibility that these bizarre germs were laboratory creations, accidentally or intentionally transmitted via tainted Hepatitis and smallpox vaccines in the U.S. and Africa—as numerous authorities have alleged—is investigated herein.

Over 590 pages
\$29.95 (+S/H)
Code: EVAE (2.5 lb.)



\$19.95 (+S/H)
Code: EVAEA (0.5 lb.)

This book reviews the numerous viral vaccine studies conducted simultaneously in New York City and Central West Africa by a narrow network of virologists working for major military-medical contractors under the auspices of the National Cancer Institute (NCI) and the World Health Organization (WHO). The text presents bizarre and horrifying facts about the biological weapons race of the 1960s and early 1970s when researchers developed countless immune-system-ravaging viruses and experimented with antidote vaccines allegedly for “defense” and cancer prevention.

SEE NEXT-TO-LAST PAGE FOR ORDERING OR CALL TOLL-FREE: 1-877-280-2866

not deferring to the “old order” of drug medications and surgeries. This includes 67% of the post-war generation (Baby Boomers and richest segment), 70% of their children (the largest segment), and 87% of their parents who are seeking alternative health services and technologies. We are referring to health and wellness modalities that are cost-effective, affordable, results-oriented, not infectious, crippling, or riddled with side-effects.

These alternative health services and technologies to date have only minimally, at best, been supported by insurance companies or governmental health programs, research funding, etc. Secretary of Health and Human Services Tommy Thompson fortunately has started in the right direction with the release of the *ABC Codes*. This is only a beginning.

Lastly, AIDS, West Nile Virus, SARS—there are more of these diseases upon us and we expect they will be coming with greater and greater intensity. We are requesting a thorough investigation as to which of these diseases have come from pharmaceutical laboratories and to what extent they are being fostered upon us to further entrench the “old order” costly systems.

With news media hype paralleling each new disease, we are being told this “old-order” system is here as our “savior”. Is this truly so? Are they manufacturing these “new” diseases in their labs (truly we like to believe no one could be so cruel and dastardly), and then are the only ones to provide the diagnosis and cure?

What is truly happening here? We-the-people of the United States of America demand an investigation and true answers. We are demanding and declaring a New Declaration Of Independence and a New Era of Freedom for the people of the United States of America.

Post-Scripts: Operation Health Freedom

1. An example of costly, often debilitating “old-order” health systems, perpetrated and locked into place in most U.S. states is the California law restricting all cancer treatments to Chemo, Radiation, and Surgery. There are many very viable modalities for treating/curing cancer.

Dr. Lorraine Day, M.D., San Francisco General Hospital surgeon (see website: www.drday.com) turned her large malignant breast cancer/tumor around nutritionally. A good immune system is the best natural first-line of defense against debilitating diseases and it is the

immune system that Chemo and Radiation is known to destroy. Is this why the FDA never approved Chemo (mustard gas) which is considered “slightly less deadly” than cancer itself?

2. It is documented that upper-echelon FDA officials will send their cancer-stricken family members to Germany in order to obtain treatments which they themselves ban in the U.S.—i.e., ozone, etc. There are many viable cancer treatment modalities available in Germany’s hospitals and clinics that are banned by the FDA in the U.S., including Rife-type frequency technologies.

3. The FDA, via the North American Free Trade Agreement (NAFTA) has set out and is attempting to close all cancer clinics along U.S. borders, particularly the Mexican clinics. Dr. Hulda Clark’s and The New Hope Clinics in Tijuana, Mexico, are among those already hit. (Clark’s remains open after a court battle.) Those being closed are usually clinics of last hope after cancer victims have been Chemoed, Radiated, and Surgeried in the U.S.

In Canada, Don Tunney, who assembles and provides Jim Bare/Rife frequency instruments was presented a “cease and desist” order by the FDA (thanks to and via NAFTA) in June/July 2002.

4. Why the FDA’s banning of Rife-type frequency instrumentation? It has been suggested that after 70 years of suppression and cover-up, if the general public becomes aware of the results and resulting unnecessary suffering and deaths caused by the “old-order” money system, there will be a public outcry and resulting litigation that will, by comparison, make the cigarette industry affair look like a small firecracker.

5. South Africa, as a result of the AIDS epidemic there, is currently investing 24 million Rand in R&D in “electo-wellness” technologies (Rife frequency-type technologies).

Germany has the Grayfield Versatile Microscope capable of viewing live microbes at 40,000 magnification. Rife’s Universal Microscope views live microbes at 60,000 magnification. The electron microscope today has great magnification; however, in the staining process, views only dead microbes. The electron microscope, as currently used in microbiology/pathology, views the dead past, while the other microscopes view the live life cycles of microbes. The difference is similar to civilizations being studied via archaeology or walking through live cities and neighborhoods of the present.

6. Bayer pharmaceutical, in May 2001, is reported to have purchased from the

current South African government, in perpetuity, all rights to naturally grown herbal/floral products of that country (and who knows how far these purchase restrictions and control processes reach into other third-world countries). Currently, the pharmaceutical cartel is perpetuating the United Nations *Codex* to restrict the worldwide use and sale of natural herbal and food supplement products.

In November 2002, the European community came under the *Codex* restrictions, leaving mostly large pharmaceutical companies in control of herbal and food supplement products there. At the same time the FDA/pharmaceutical industry is making every attempt to restrict and control all natural herbal and food supplement products sold here in the U.S. Does this smell of a worldwide FDA/medical/pharmaceutical cartel conspiracy? Certainly this is worthy of investigation.

7. Naturally grown products cannot be patented. Artificial, chemically produced/created pharmaceutical products can be patented. Resulting very costly prices are obtained from these patented drug products, prices most often supported by high insurance premiums, costly government/taxpayer support for pharmaceutical aid to seniors, “health and welfare” programs for the poor, etc.

Are these artificially produced petroleum-based products toxic to the body? Read the warning labels because they tell the story. The same process applies to the cosmetic industry; if it’s natural, it is not patentable. If it is artificial, even laden with very toxic chemicals, it is patentable (with no FDA approval or monitoring required).

Follow the industrial money trail from petroleum to chemical to pharmaceutical and cosmetic, then discover the trail of toxicity from one industry to the other, and then to the human body. Bill Meyers made a report showing where the chemical industry is using the cosmetic industry as their toxic chemical dumping ground. The EPA would be “all over” the chemical industry if these same chemicals were placed in the environment, and yet, as extremely toxic as some of these chemicals are, they can go onto the human body and never fall under the attention of the FDA. Is it any wonder why just 40 years ago cancer was expected to reach 1 of 25, and today it is expected in 1 of 3 or less?

8. The not so BIG SECRET. Cellular receptors in the body respond to frequencies. Frequencies will fracture the membranes of viruses and bacteria, etc., and destroy them. Frequencies will assist

in cellular cleansing, regeneration, and healing. Minerals (as in mineral supplements), herbs, food supplements, and yes, even pharmaceuticals are carriers of frequencies, and this is how they work and operate.

Minerals, as found in fruits and vegetables at ionic size, will readily pass through the cellular receptors and provide natural nutrients at the cellular level. Pharmaceuticals will pass through the cellular receptors the same way; however, they are artificial and for the sake of being patentable are manufactured with exotic substances that are often toxic and will often lower the body's natural blueprint frequencies, thus allowing other ailments to take over, and consequently the dreadful side-effects that require one after another drug to mask over the symptoms of the prior drug, etc.

9. Why the threat to the pharmaceutical/medical system? Because natural herbs, food supplements, essential oils, and frequency instrumentation are not noted for toxic side-effects, lowered immunity problems, destroyed benevolent intestinal flora (primary cause of candida problems), lowered body/organ/hormonal blueprint frequencies, etc. They are not the cause of 100,000 drug-induced hospitalizations per year, and the cause for 10% of all hospitalizations in the U.S. They are not the cause of 270,000 hospital infections, or misapplied or abusively applied pharmaceutical deaths per year in the U.S.

10. Currently in Iraq, as the war there comes to a close, we are witnessing the looting and burning of that nation's cultural heritage, and the whole world suffers for this. Silently our own nation experienced looting and burning from this nation's records and history books, removing the memory of one of our greatest geniuses, Dr. Royal Raymond Rife, who is right up there with the likes of Tesla and Einstein.

The medical/pharmaceutical cartel saw this man as a major threat to their monied monopoly interests because of his inventions and discoveries. His Universal Microscope made it possible to view (by refractive light) live viral and other pathogenic forms. He was the first one inventing the means to view live viruses, bacteria, and other pathogens, and then he developed the means to devitalize and destroy them.

In the human body this destruction of harmful pathogens takes place without the harmful side-effects often experienced from pharmaceutical drugs. We are looking forward to the day this great 20th century genius, posthumously, is honored with a Nobel Prize. Some have suggested

he may become the first to receive two Nobel Awards.

[end quoting]

As Jim makes the point quite clearly, should enough of the public become aware of what the medical/pharmaceutical industry has suppressed that would bring true health, there would surely be a mutiny. The problems of the tobacco industry would pale by comparison.

Continuing with the presentation of this matter, I next present a letter written by Jim Folsom's wife, Sata Burwell, to the Assistant U.S. Attorney, following the raid on their home:

[quoting]

Letter From Sata Burwell

Melanie K. Pierson
Assistant U.S. Attorney
U.S. Attorney's Office
880 Front St., Room 6293
San Diego, CA 92101-8893

Re: Case No. 03mg0800

Dear Melanie:

Why was my house raided and terrorized by your armed Federal FDA agents? Why were my Rife frequency instruments taken from my bedroom and my living room where I use them daily for research purposes and for my personal health and wellness?

These instruments are vital for my health. They were hooked-up and operating at the time your agents took them from me. Since they are legal for me to use and operate, I do not understand why you have taken them. For the sake of my health and wellness, I demand they be returned to me immediately.

I am Asian, and I do not believe in putting toxic chemicals and drugs into or onto my body. I do not work full-time and cannot afford expensive health insurance for drugs, doctors, and hospitals. Your American hospitals are infectious and costly. This is why I rely on this available technology. Why should you take it from me?

Months ago I experienced what it is like to visit your American hospitals. I had heart palpitations, so I visited Dr. Cao, M.D. He put me on heart diagnostic equipment to find out what was wrong. While in his office my heart began racing and I was passing out, with difficulty of breathing, and I was scared. Dr. Cao had me rushed to the hospital emergency. There they put me on monitoring equipment, gave me IVs, Tylenol, and nothing more. Three and a half days of this, and \$10,000 later, I went home. The

next day I visited Dr. Nguyen, M.D., cardiologist, for further testing. He recommended drugs which I did not use. At home I used natural dietary supplements and the Rife instrument, and now I am healthy and well. Is it because your Federal Drug agents want me to use expensive drugs that they took this equipment from me?

I rely on this Rife technology that works to make me healthier and healthier. If a cold or flu comes along, I can usually get rid of it in a few hours and not have to take drugs and suffer for days, or weeks, which would usually be the case.

A year ago, I had two ugly cataracts that were blurring my vision. I used the frequency instrument, and 10 days later the cataracts flaked and peeled away. My vision is good again.

Three years ago I was working at banquets for a local hotel. My arms and shoulders were becoming numb and partially paralyzed due to heavy lifting. As a result, I would wake up in the night crying for fear of what was happening to me. I did not believe I would live to the age of 50. Then I was laid off from my full-time work and could not receive Workmen's Comp or disability payments. That is when I was introduced to the Rife frequency technology. Today, my health is back, my shoulders and arms are serving me well, and I feel healthier than before.

On another occasion, I experienced a severe appendicitis attack where I was buckled-up in pain. With the use of the Rife equipment, the infection, swelling, pain, and blockage cleared within a 2-hour period and I was back immediately in good health. Your drugs, hospitals, and surgeries could not accomplish this with such speed.

Today I would no longer have a very necessary organ to my body had the surgeons gotten to it first. They would have cut it out and discarded it in the nearest dumpster. Financially this would have likely cost me well over \$20,000 between the ambulance, emergency room, doctors, anesthesia, surgery, and hospital stay.

Can I have my Rife instruments back? I was using them for good and I was harming no one, not even myself. They give me no side-effects like the expensive drugs the doctors want to give me. Why should I put those harmful chemicals into my body?

I have my own dietary food supplement distributorship. This is how I make a living. These supplements help to keep me and others healthy and feeling young. I reference my product brochures "BioSolutions". I wonder if this is a crime because your Federal agents took away

some of my equipment that I need for my business. Do I also deserve this?

I feel violated by the intrusion of your armed Federal FDA agents into my home. Is that what it is to be "free" in America? My father was a policeman back in the country where I came from. I hope he never did to anyone as your Federal agents did to me and my home. I left my home in S.E. Asia to be away from this kind of police terror and tactics. Shame on your people in America for allowing this to happen in your great country. I fear for you, America.

I now wake up in the middle of the night, frightened and wondering if this is going to happen again. Are these strangers going to return and steal from me? Your Federal agents went through my entire home, through my bedroom, drilled open my safe where I keep my valuables, documents, and business contracts, etc. They took family video tapes and business contracts from the safe. They took my Rife instruments. Why?

It occurred to me while writing this letter why most Americans are not truly "free" as they like to believe. Coming from outside I can see what is happening here.

You have a medical/pharmaceutical system in crisis. Your people can no longer afford health insurance. So much of your national economy is caught up servicing a health system that is nearing total failure.

Your medical doctors are running scared because the best of your drugs are not keeping up with the mutating and new oncoming viruses and bacteria. Your drugs only mask over the symptoms of the prior drug. Your elderly are fed cupboards full of these costly drugs. Your children are drugged to keep them "attentive" in school. You fight a costly "war on drugs" while your whole economy is based upon drugging your people with some of the most toxic and costly drugs.

You pay and pay and pay for this craziness. Most of you are living from one paycheck to the next, hoping and praying you are not laid off or lose your job or become ill and can no longer work. Your people are enslaved to a system and don't even realize the entrapments you are in, and you still call yourselves "free".

Who is kidding whom? I truly feel sorry for all of you.

Melanie, now I understand why you sent your terrorizing Federal FDA agents into my home. They have a very long history of these terror tactics in ruining families and health businesses and technologies that do not conform to your

monied enslavement system. I and others chose to step out of this system by choosing other technologies, and now I truly know why your Federal armed agents had to come after me and the business my husband is associated with. My husband chose to help others get out of the medical system entrapment. There is a better way, but this is not allowed because your government is dedicated to protecting a failing system. Even the economic security of your country would be shaken if there were a public awareness of technologies and means to good health, as described above.

P.S. I am formally requesting of you, as the Assistant U.S. Attorney authorizing the raid on my home, that you provide all names, contact addresses, Federal Departments, or other departments and locations, their authorizing supervisors' names, and by what legal authority they approved this raid, badge numbers, etc., of each and every person or agent who entered my home, including the locksmith.

Several years ago a local sheriff investigating a burglary returned later a burglar himself. I fear this will happen to me. I do not sleep well knowing these strangers may return at night, with no good intent.

Enclosures: Hospital and Medical Statements

[end quoting]

As she says so well above, just what is it that's FREE about the United States when Big Business can dictate governmental actions so blatantly at odds with fundamental constitutional rights of the citizenry?

To explore this critical matter further, on April 24, 2003, I had the opportunity to speak with Jim Folsom about the FDA raid. Here is what he had to say:

Interview With
Jim Folsom

Folsom: This is Operation Health Freedom. Now, it involves raids here in the San Diego area. My house was invaded. This was a period of time when there were incursions starting into Baghdad, April 2. This was seizing property.

There was a tremendous amount of civil and constitutional rights violations, spearheaded by the FDA and the Postal Inspector, and half a dozen other people.

Let me just lead into this. What we're doing is stating that, while Bush was sending in troops into Iraq to free the Iraqi people, our homes were being invaded by federal police and agents, under the authority of Bush. We're asking for a New Era Of Freedom in this country. Look at what is happening. On July 4th, our Independence Day, we're asking for a New Declaration Of Independence and a New Era Of Freedom for the American people.

Martin: It's interesting you should say that because—do you know what the headline of our June issue is?

Folsom: [Laughter] Tell me.

Martin: You're the first to know.

Folsom: Ok, beautiful.

Martin: "Operation American Freedom"

Folsom: You're kidding. This is perfect.

Martin: It sounds like the synchronicity here is pretty good.

Folsom: I knew when you said this would be in your July issue that it was timing brought in from Higher Levels.

Now, my end of the operation deals, basically, with electro-wellness, the instrumentation you're aware of. It's advertised there in *The SPECTRUM*. We look at this as more than frequency instrumentation, more than herbal, dietary supplementation, more than the old term "alternative".



"I stopped taking the medicine because I prefer the original disease to the side effects."

The new terminology, as Tim Bolen told you, is “advanced wellness”. It’s the total area of American freedom, and getting back to American rights, as the *Constitution* provided. That’s the basics of it.

When these raids took place, they weren’t just of my home. I was anticipating this two days ahead of time, and was not frightened, or scared, or anything else; but they took a major amount of stuff.

But I saw it as, they were opening up the OPPORTUNITY for what we’re seeing here, coalescing people on all levels. This is the opportunity to make it happen. And there is no greater opportunity than right now, with this coalescing, and the American people’s involvement on a major scale. When we get this out on the Internet, there is no reason why this couldn’t be—well, it WILL BE BIG-TIME!

When we talk about the tobacco affair, what has been brought on by these powers that have held the “old system” together, as this overturns, it should make the tobacco industry situation look like a small firecracker, and everything that’s gone on for most of the last century, that’s holding a failed system in place, and that’s what we’re dealing with, a failed system.

The FDA claims “right”; they came in with the idea that this is an “unapproved” medical device. They were given, by Congress, a 1977 law to, basically, set up control with this. With that they were given responsibility to put together an independent review board for any growing, new technology of public interest. THEY TOTALLY IGNORED THIS. They abrogated, as a result, any authority over this area. And they are stretching the imagination when they say it’s a “Class-III Instrumentation” case; I can’t go into all of that.

But, we’re on a roll, and it’s happening.

(We continued with our interview on 5/1/03:)

Martin: When were your raided, and who raided you?

Folsom: The raid was at 9:00 on April 2, by the FDA, Jim Logan, and the District Postal Inspector from Los Angeles, Patricia, and there were several other people, not providing names. I did request names; they did not provide them. I requested names, badge numbers, and department locations, and I was told I would have to request that from the U.S. District Attorney, or Assistant District Attorney, Melanie Pierson.

Martin: Have you done so?

Folsom: I have not, at this point. I am

working through the attorneys. That is in part of the letter that was put together. (The letter from Sata Burwell above.)

Martin: And who is your attorney?

Folsom: I am working with Jim Turner, Esq., from Washington, DC. He’s a former FDA attorney. And, as it becomes necessary, we’ll have attorneys out here in California.

Martin: Were you served with a Warrant?

Folsom: Yes, and it’s under a “Gag Order”—sealed. There was a Search Warrant and a Subpoena.

Martin: And it’s sealed because it’s pending criminal prosecution?

Folsom: Correct, from an investigation ongoing from about August 1999. Now, with this—I don’t know if they were just raids, but there were similar shut-downs here in San Diego, same technology.

Martin: On the same day?

Folsom: No, several years back. And then, December 1, 1991, there was a raid on the Biotech 2000 people in the San Francisco area. There was Jacque Bovee and Roger Whitman—they went into their homes and confiscated materials.

Martin: When you were raided, how many people participated in the raid?

Folsom: There were approximately 7 people, total.

Martin: Who was present at your place?

Folsom: There was one lady from Mexico, my wife Sata, and myself.

Martin: How were you treated?

Folsom: I would say, once they heavily knocked on the door, pounded on the door and said “Federal Police, open-up”, they came in, they rushed in, and basically secured the area. They were armed. From that point on, they were cordial. They had us sit in the corner of the living room, after they searched the sofa, etc.

They were hauling out boxes.

Martin: Documentation?

Folsom: Yes, documentation. There were frequency instruments, which I told them I had to do some repair and servicing on. People had paid good money for these instruments, and I was here to see that they were provided the service, whenever it was necessary.

Now, when the agents came in—they had the blue jackets, like FDA, Postal Inspector, the others would have Federal Police on the back—one of the first questions I asked them is: Is this instrument legal for me to own?

The answer was “Yes.”

Is it legal for me to use and operate?

The answer was “Yes.”

Is it legal for anyone else to own?

The answer: “We know where you’re

going; we are not going there.”

Martin: [Laughter]

Folsom: They rounded-up the instruments. The subpoena, etc., had full territory; anything that related to Rife equipment, they seized and took. They took videos that did not even relate. They took all the John Crane videos that I had, showing equipment, talks he gave around the country, etc., Rife CDs, Barry Lyne’s books, his latest one that goes into the conspiracy, the FDA with the pharmaceuticals, and the NIH, and the Cancer Institutes, Kettering Sloan, etc. Now, in this raid, they went through the house. They went into the bedroom and disconnected these instruments that I have that were hooked-up to the electrical supply; one was in the bedroom, one was in the living room, it was on at that time. These were instruments that they said were legal for me to have! Their response was: “We’re taking them, anyway.”

Martin: How many machines did they take?

Folsom: Out of the house here, they took—these were used instruments, one was new that had been returned from the Postal Department—they took about 16 machines.

Martin: That’s a lot of money.

Folsom: Yes. But they hit another person who I was working in conjunction with, and they took about 60 instruments from him. They hit a storage facility too. All total, it was a retail value in the neighborhood of \$2,000,000.

The same identical instrument by the Energy Wellness people was hit the following day, raided. That is Bruce Perlowin, in North County.

Martin: He is being charged, as well?

Folsom: No charges.

Martin: Yet?

Folsom: It doesn’t mean there won’t be an indictment.

Martin: Assuming you’re arrested and charged later this summer, is your approach a counter-action, a separate suit in Federal court, or is it as your defense?

Folsom: We’re aiming for counter-action. One of the items could be in the category of a Class-Action suit; it could be in the category where the attorneys took on the cigarette industry.

In doing so, we would make that affair look like a small firecracker, considering all the pain and suffering and the death that has gone on without warrant over the last 70 years—and all in conspiracy and collusion and suppression.

Martin: You mentioned using a Washington, DC lawyer. Is he prepared to go the distance?

Folsom: We need to get the funding in.

This is very necessary. We will be calling upon the public to make donations.

Martin: So, a Legal Defense Fund?

Folsom: A Legal Defense Fund, yes.

Martin: How is your and your wife's general attitude?

Folsom: It's a little tough along the way, the way my wife takes it.

What I'm looking at, I feel this is a major opportunity that we have actually been looking forward to, we've been anticipating, in order to galvanize everyone in the "alternative health field", to get the publicity out, and to turn this whole corrupt system around.

The current medical system is lagging-edge, and it is in crisis. There are no answers where they are currently looking for answers. The answers are: bringing-up the whole advanced medical system—when I say advanced, that's the terminology for what was used for "alternative health". This is for health and wellness, not for treating symptoms, as the old mode has been—and symptoms with drug medications, to bring on another symptom, to bring on another symptom with another drug.

We've got to get away from that. We've got to get into building the immune system, detoxifying the body, clearing the parasites, etc., and bringing the body into a healing mode, as we were created.

The natural direction of the body is toward health. We want to be able to facilitate that. We are moving away from the "alternative" concept terminology; we are into "advanced wellness" or "advanced medicine, health, and wellness".

Martin: It's like us here at *SPECTRUM*. We cringe at the phrase "alternative media". We're not alternative media; we are TRUTHFUL news media! So, you are the health industry, the wellness industry.

Folsom: "Alternative" implies subservient or secondary, and that is totally out of place. We are advanced! "Alternative" means that we are on the defensive. We are no longer on the defensive; we are on the offense!

Martin: Another thing that you've just mentioned, that Bolin also stated, which is true, is that so many of the Rife-related and so-called "alternative"-related businesses are either not talking to each other, or there is not a coordinated unity among them. Therefore, as individuals there is a vulnerability to attack. And it's through a united front that greater leaps and bounds may be made.

[*Editor's note: Some of you may remember this same crucial point was made by Native American leader Red Elk way back in our April 2002 front-page*

CONTACT JIM FOLSOM

For those of you readers wishing to write to Jim and Sata directly, you may do so at the following address:

Jim Folsom & Sata Burwell
10464 Clairemont Mesa Blvd., #175
San Diego, CA 92124
Fax: 858-565-9708

And for those of you wishing to support their legal defense fund, donations can be made to:

Operation Health Freedom — Defense Fund
c/o Swankin & Turner, 1400 16th St. NW, Suite 330
Washington, DC 20036
Office: (202) 462-8800
Fax: (202) 265-6564
email: jimt@swankin-turner.com

For further information on how to help out, visit the Operation Health Freedom website: www.othf.org

feature story. He talked in more general terms, that "people of Light" needed to come together in a united front and not allow themselves to be so easily divided by differences that don't amount to anything important—except perhaps for feeding egos! The dark elite controllers work to foster such division since, should the "people of Light" come together, then the longtime dark control game is over—whether it is control over our rights to good health or control over any other of our fundamental freedoms.]

Folsom: This is absolutely the case, and this is where it is. And this is why we see the opportunity here to galvanize, to bring together. It does not mean that the people in the Rife and the frequency instrumentation field will necessarily galvanize, until THEY become a direct target. And the powers that be, like the FDA, have stated clearly that they will take down each and every one of them.

Martin: I would believe them. They are out to do it. They have the money; they have the resources; they have the man-power; and they can do it. [*Thanks to YOUR tax dollars; how's THAT for the ultimate insult?!*]

Folsom: That is what they are targeting, not to take down just the Rife equipment. But if they have their way, to take down anything that is in the dietary and whole-health fields. But, THEIR time is short, and it's time for US to act!

We include the herbal and homeopathic industries, that they see these as

extensions of where we are, because homeopathy, herbal, ARE frequency-based. They are resonant-frequency modalities.

Martin: Everything is frequency.

Folsom: The pharmaceuticals—and they don't want to have this out I'm sure—even pharmaceuticals deal with frequency. Whether it's herbal, dietary, anything, it's all frequency, but some of lesser value. The problem with pharmaceuticals are the toxins that come along with them, and they come from a petroleum base, and they're drawing from animal substances, etc. They have to synthesize, in order to get something patented, to have their controls over it.

Martin: Do you want to tell me more about the raid itself?

Folsom: The Postal Inspector came in, Postal Department, on the supposition that "there was a fraudulent return address label on a package".

Martin: [*Laughter*] Excuse me, I shouldn't laugh.

Folsom: [*Laughter*] This is true! Now, this was a postal annex, and they said they could not trace the owner of that particular box. This is how they termed it "fraudulent". It happened to be a long-term box, and they may have changed the rules along the way in signing-up for the boxes. It was paid, current.

Now, that label was on a Federal Express package. FedEx is, I'm told, working right in conjunction with the Postal Department today. The Postal Department may not

OPERATION HEALTH FREEDOM

For those of you readers wishing to know more about Operation Health Freedom, visit the following websites:

www.othf.org (Operation Total Health Freedom)

www.gohf.org (Global Operation Health Freedom)

have been informed of this, but the over-riding label was the large, preprinted FedEx label, my home address, with my phone number, in my name, and my FedEx account number.

Martin: And this was all on the box?

Folsom: All on the box, and this was a box going to the United Kingdom. The FDA saw my man going there to FedEx, after it was paid for, contracted for constitutionally, they went in and seized that package, and that was not the only one they seized. They were seizing packages, shipments in the postal system, as well.

Back to the raid here. They came in and had us on the sofa.

They tried their interrogations. There were no Miranda rights. There were no charges. And they started asking me for a plea-bargain, and they started reeling out information.

And I said: "What information? There are no charges! How do I respond? How do I reply?"

Let me back-up. This was between the Postal Inspector and the FDA Agent—they were playing "good guy-bad guy" here—and they brought up a phone conversation that I made to FedEx, when I was trying to track that package through the FedEx tracking number. Apparently, I was switched over, I suspect, I was switched over to someone who was an FDA Agent. I said there was a prior FedEx package, ground shipment to Florida, that never arrived. When I called up to track that, they said it was damaged.

I said: "You didn't inform me? Why was I not informed? What was done with it?"

Response: "We destroyed it."

They don't do that. They confiscated it; they seized it!

Get this one: during the interrogation they said they have a recording where I referred to British Homeland Security.

I then said: "British Homeland Security? I never knew such a thing existed! I've never used that terminology; you guys are way off-track here."

Then I said: "You guys are asking me for a plea-bargain? You've already convoluted the first opening statement of

what I, supposedly, said. Anything, even if it were writing, you would know better than I do that it would be totally convoluted, fallacious, and have no value."

Silence.

Then the FDA Agent says: "You seem like an honorable and good guy, trustworthy."

My response: "Why do you say that? I never implied such."

Then it was interesting, the two of them jumped on me with the "good guy-bad guy" routine of interrogation. They said: "You cannot lie to a Federal officer." She jumps in: "It's a Federal offense, a felony offense to lie to a Federal officer."

At this point I said nothing. I pointed to the FDA Agent and I looked him dead in the eyes and I said: "Don't even go there. I did not lie to you. I do not intend to lie to you. I did not in the past, the present, nor do I intend to in the future."

At that point they started backing-off. They knew they were not getting anywhere, and they went about their seizure processes. They even went into the bedroom, etc. They could not open the safe. They brought in a locksmith; they drilled it; and finally reset it. They took contracts out of there, one of which was for a foreign country that has government registration of this instrumentation.

In the meantime, the FDA is trying to say this whole technology is a myth, no value to it, never proven. There was never anything proven with Rife; that's what the Agent was saying.

Also, there has been some significant stuff going on here in San Diego associated with the people dealing with Rife—we're talking about across-the-border items.

Some of this first started out when I had received a call from the FBI. They said there is some significant information we need to get to you, can we set up an appointment. Two Agents arrived at my home. They said, due to a recent law passage, they can head-off potential kidnappings, etc. They said that I was subject to being kidnapped, while first enticed across the border for a business

deal—and enticed to return, at which point I would be kidnapped and either done away with, or the message would get across that I would not be dealing with these instruments anymore. Now, basically, not drug cartel, but a private-eye that got involved with the marketing of the instrumentation, and wanted to not have competition. This went on.

Then, during the interrogation by the FDA, they asked me to "spill the beans".

I said: "I don't know what you mean. All of this is on the record. I've had as many as six FBI Agents in my home; go to the FBI."

And what's interesting is, I don't fully understand it, but I saw fright on their faces, from not doing their homework, plus there is always that competitive situation between agencies. But they were caught unaware, and they knew it. And there may be some significant legal implications here, also. That was the one time they flinched. I never flinched through the whole operation.

Martin: Jim, do you want to take a few minutes and bring this in for a landing. What do you want to say that would be a general statement to all of our readers about this whole issue, and what is at stake?

Folsom: WHAT IS AT STAKE IS THE RIGHT OF THE AMERICAN PEOPLE TO HAVE THE FREEDOM OF CHOICE TO HAVE THE ABILITY TO TAKE ON RESPONSIBILITY FOR THEIR OWN HEALTH AND WELLNESS. THIS IS WHAT IS BEING DENIED THEM, COMPLETELY. THIS IS WHAT IS BEING DENIED THEM THROUGH THE SUPPRESSION GOING ON.

There is the fear from the whole conspiracy cartel situation, the knowledge of this type of technology, which is user-friendly; it is free of side-effects, and so often conditions can be eliminated in one or two sessions. Sometimes it can go on for longer periods, requiring detoxification and cleansing of the body, then clearing the condition. There are no guarantees that it will work in every instance.

But it's a matter of FREEDOM OF CHOICE for the American people. And this is not just an issue of frequency instrumentation; it's the whole dietary, supplement industry; it is into the advanced wellness, the prior "alternative" wellness territory, the freedom of Americans to have this.

It goes beyond that, even. This comes down to basic constitutional rights. Who is in charge here?! Is it a dictatorial bureaucracy or systems of bureaucracy? Or, is it the American

people who have the choices? Is it the people who determine their own path? Who serves whom?

This is the vehicle that we have here, to allow the American people to coalesce behind a movement. This is exactly what it is leading up to, at this point. And it is expanding and growing at a very rapid rate.

We welcome and we urge everyone who has an interest here to come aboard and see this to the end! These are American freedoms! We're coming upon the 4th of July here, Independence Day, dealing with what we would like to see as a New Declaration Of Independence, and a New Era Of Freedom in this country.

Martin: Thanks for sharing that with our readers; they're on your same wavelength about the issue of freedom.

[end quoting]

So there you have an up-close-and-personal account of a recent action by the medical/pharmaceutical gestapo. This time, however, they've picked on someone who is not about to roll over and play dead. In many ways, Jim is a patriot fighting for freedom in the fullest sense our Founding Fathers intended!

Dr. Len Horowitz

To add another important perspective to this volatile issue, I've asked longtime *SPECTRUM* friend Dr. Len Horowitz [see *News Desk*] about his views on electro-medicine and recent attacks by the FDA on the Rife frequency technology. Here is what Dr. Horowitz had to say:

[quoting]

Martin: What is your stand on the use

of frequency technology as a wellness option?

Dr. Horowitz: I think it's absolutely rude that the federal regulators have in any way, shape, or form infringed upon the rights of human beings to practice what is, clearly in the *Bible*, in the book of *Numbers*, Chapter 7, Verses 12-83, in my book *Healing Codes For The Biological Apocalypse*, we showed you that those are the electromagnetic frequencies for, virtually, creation, destruction, and miracles, including miraculous healings. The third tone of that ancient musical scale, it's a set of six tones known as the ancient Solfeggio musical scale, has to do with repairing damaged DNA. All the tones have to do with an affirmation of who we are as spiritual beings, first, crystallized into physical matter, ultimately by the voice and music from the Heavenly Throne.

The bottom-line is that, if there is to be separation of Church and State, and if there is to be religious freedoms, then this particular case could be landmark in setting precedents for affirming our right to exist without government infringement on the entire field of electro-medicine, as it speaks to, above all, our spirituality.

Now, let me also add to that point. The concept that DNA is simply a protein-synthesis machine that is directing RNA to send messages to the ribosome, which is the protein manufacturing station of the cell, and subsequently, that creates proteins being formed, which gives rise to new cells and new life. That has been the focus of what we have learned about genetic interests and biotechnologies, namely, that the DNA is simply a

physical, mechanical blueprint. That is absolutely false and misleading, based on the most recent science, in the fields of genetics and resonance and biotechnologies and water science, in particular, which shows that the principal function of DNA—that is, about 93% of its active function—is as an electromagnetic receiver and transmitter.

Technically it's called "photon-phonon emissions for intercellular communications and for cellular regulation". Photon is light; phonon is sound. Over 90% of the function of DNA is to receive and transmit electromagnetic frequency signals for everything that is going on in the cell, at any given instant. That means, the enzymatic reactions, the development of the energy processes, the neurological and immunological and endocrine functions, everything that is going on is a manifestation, first and foremost, of electromagnetic frequency signaling.

THAT'S THE BIG SECRET IN MEDICINE!

The Food and Drug Administration is acting as a virtual Gestapo for the pharmaceutical interests and those who wish to continue to control humanity. Ultimately this knowledge, this truth, has the capacity, literally, to set not simply the field of electro-medicine free from such control, but humanity entirely free, from virtually the shackles of ignorance as to who we are as physical beings, second, and spiritual beings, first.

So, that's the wonderful opportunity that's been presented by the Adversary, through the Food and Drug Administration, with regard to this case.

NEW!

Anthrax, Smallpox, Vaccinations, And The Mark Of The Beast!

by Dr. Leonard Horowitz

If you are one of the millions of people concerned about recent bioterrorist threats in the wake of the Sept. 11, 2001 attacks on America, prepare yourself for a reality check. This shocking video analysis of the little known facts regarding threatened outbreaks, and the science, economics, and global politics underlying bioterrorism and forced vaccinations, features one of America's most riveting speakers. Among the world's foremost authorities on the subject of bioterrorism, vaccination risks, and public health, Dr. Horowitz's expert diagnosis here dovetails perfectly with *Bible* prophecies. Pay special attention to his disclosures regarding the infamous "Mark of the Beast". Dr. Horowitz reveals sacred *Bible* codes that give expanded meaning to the infamous "666" prophecy (*Rev. 13:18*) while implicating widely trusted vaccinations, medical biochips, politicians, and institutions that have advanced some of the most horrific population-controlling ploys ever conceived. Anthrax, smallpox, and vaccinations are all part of the same deadly swindle. Watching this video may do more than raise awareness. It may help save millions of lives!

2-TAPE SET
2 hrs. & 40 min.
\$39.95 (+S/H)
Code: ASV (1.0 lb.)

SEE NEXT-TO-LAST PAGE FOR ORDERING OR CALL TOLL-FREE: 1-877-280-2866

NEW!

Star Wars Weapons And End Times Warfare!

by Dr. Leonard Horowitz

If power is the game, and population control the aim, the world's most advanced weapons and energy technologies would be directed from space. Star Wars Weapons would be able to change everything from the weather to people's moods, thoughts, behavior, and health.

Have you noticed the weather has been changing? Are you like millions of people who no longer feel as good as you know you should for your age? Welcome to the new world of electromagnetically managed chaos heralded by U.S. National Security Advisor Zbigniew Brzezinski in his book *The Technotronic Era*.

3-TAPE SET
3 hrs. & 40 min.
\$49.95 (+S/H)
Code: SWW (1.5 lb.)

In this video presentation, Dr. Leonard Horowitz, an award-winning internationally-known public health authority, discusses these technologies for war-making and population control. He explains how toxic metals and human genetics can now be manipulated from space, providing an insidious arsenal with which to conduct genocide in the name of "national security" and the New World Order's "war on terrorism".

SEE NEXT-TO-LAST PAGE FOR ORDERING OR CALL TOLL-FREE: 1-877-280-2866

I plan to be as active as I possibly can be, working with my colleagues to assert our religious freedoms and exemptions from any legislation that would impair our ability to utilize this technology and this knowledge, to the greatest ability that we have, to uplift the physical and spiritual well-being of people all over the Earth.

Martin: Well said! Wonderful. What is your feeling about the effectiveness of these kinds of technologies for wellness applications?

Dr. Horowitz: It's something that we observe daily, we absolutely experience daily in many ways that are not even perceived. The fact that the new science shows that the electrical signaling in the body affects the nervous system, the nervous system itself, the transmission capabilities of cells, and ultimately tissues, the fact that all of this is being utilized by clinicians in Naturopathy, and electro-medicine, and acupuncture (Oriental medicine), herbology, essential oils techniques, light therapy, color therapy, sound therapy—ultimately it's all based on the fundamental principle of the way the entire Universe operates according to frequencies. And, ultimately, the clinical results are well established.

You have the American public currently clamoring for these services, even though it's mostly out-of-pocket expense, not covered by third parties. Obviously, people are moving away from the fraud of slash, burn, and poison healthcare, to the preventative and alternative healthcare practices that involve natural healing. And ALL of natural healing is based, again, on this concept.

When you think about even the concept of loving, heart-filled intent, and the effects of prayer on healing, or the Placebo Effect, you have to consider how it is that thoughts, ultimately, effect the physical body, and either enhance our immune system or disable it. What's been now proven increasingly, is that it's ALL electromagnetic phenomena ultimately being expressed in a more physical form.

So, the science of frequencies is tremendously powerful. It is THE most powerful! It really integrates your concept of the Great Creator with the physical beings, the living creatures, on this planet.

[end quoting]

So now you see a much larger picture in which to place Rifle-like technologies. In that larger picture, both the power for good and the threat to the status quo become all too clear!

Interview With Tim Bolen (JuriMed)

With that point established, we now turn to a conversation I had with Tim Bolen on 4/29/03. Who is Tim? Well, noted on his business card is the following statement you can probably identify with by this point in the story: "Strategies for government-beleaguered health professionals." That ought to give you a good idea of where he fits in. Here's what he had to say:

[quoting]

Bolen: I'm going to give you my opinion about what is going on because I am an opinion writer, and that gives me a little more latitude in terms of what I think is going on. All I have to do is show that I have good reason for it.

Here's what is going on:

There is an organization called the Quackbusters who, in my opinion, their only objective is to shut-down competition to the drugs and surgery paradigm.

[Editor's note: See the great story on page 11 in last month's News Desk relating the sound thrashing these weasely Quackbusters got in a California court recently. The tide is turning and signals the possibility of great gains for freedom if enough people take advantage of these conditions to act with a concerted focus.]

Martin: It's my understanding that they got hammered recently.

Bolen: They sure did, and I was one of the people who arranged that! We set them up, staked-out a bleeding sheep in the jungle, and waited for the lion to show up, then shot 'em. That's what happened to them. They walked into a trap. Having said that, here's what has happened:

They call themselves *quackwatch.com*. We call them quackpots, so my competitive website is named *www.quackpotwatch.org*.

Now, on my website, I've got on the left-hand column an article called *Who Are These Quackbusters?* I did a considerable amount of research to figure out who they

are, talked to authorities, followed-up from Jim Carter's book *Racketeering And Medicine*, and how these came to be, and how they came to be a power in the United States today.

Now, the Quackbusters, several years ago, as part of their project, began to influence certain employees in our government agencies to their way of thinking. They have, I think, three employees under their influence at the Federal Trade Commission (FTC). One of them is named Michael Milgrom, Esq. He's an attorney out of the Cleveland office, and he's the one who attacks everybody with his letters. He's the official attorney for one of their subgroups, called Operation Cure-All, which you can find on the Internet if you go to any search engine and put in Operation Cure-All.

You'll find that Operation Cure-All was funded, several years ago, to the tune of \$10 million dollars.

[Editor's note: Who do you suppose has this kind of money to throw around on relatively small projects? Following the money trail has always been a good way to reveal a conspiracy in disguise.]

But since that time, they basically have attacked—and on their website they make claims to shutting down—these terrible people. But these terrible people, from my investigation, there are 8 of them last time I looked, are all mom & pop operations who couldn't afford an attorney to fight back. So, that's their big claim.

Now, Milgrom is the attorney for that group, plus he sends out nasty letters to people about Internet operations. They have two others: Matt Daynard and another named Richard Cleland. Richard Cleland's claim to fame is, every time Stephen Barrett ends-up in an article in a newspaper or a magazine around the country that has anything to do with the FTC, Richard Cleland is there speaking, right alongside Barrett. That's the major connection there, against whatever it is that the FTC is attacking.

Since no one in our organization, the North American Health Freedom Movement, has paid any attention to how the politics works, the Quackbusters have had free reign with their three people at FTC. What I think has happened is, those three have put together a little program to convince Timothy Muris, the Bush appointee and his group up there, that there are real problems out here in the world, on the Internet, and one of them

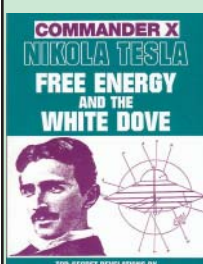

COMMANDER X
NIKOLA TESLA
FREE ENERGY
AND THE
WHITE DOVE

TOP SECRET REVELATIONS BY
FORMER MILITARY INTELLIGENCE OPERATIVE
ASTOUNDING DISCOVERY—ANTI GRAVITY CRAFT
NOW BEING TESTED BY U.S. GOVERNMENT

\$15.00 (+S/H) Code: FEWD (0.75 lb.)

SEE NEXT-TO-LAST PAGE FOR ORDERING
OR CALL TOLL-FREE: 1-877-280-2866

NIKOLA TESLA: FREE ENERGY AND THE WHITE DOVE

Exposes the most important alternative scientific advancements of our time utilizing free energy concepts which were uncovered by Tesla and perhaps derived from other-worldly sources.

About The Author: A former military intelligence operative who has kept his identity a secret claims to have worked inside underground bunkers in Area 51 where he actually flew UFOs via telepathy and levitation methods derived from contact with ETs.

is “energy medicine” or what is called “electro-medicine”—because that, frankly, competes very quickly and very strongly with the pharmaceutical industry.

The big push now with this Operation Cure-All and from the FTC, they went to San Diego and they got hold of the U.S. Attorney there, and if you know how U.S. Attorneys work, they are almost autonomous from region to region. It must have come from very high to get the U.S. Attorney’s attention.

They assigned a prosecutor down there in San Diego; I have not met the woman, I only know her first name is Melanie. But, from her description, she’s in her mid-30s; she’s on a fast-track for upward. They’ve given her this case, and she is just an attack-dog that goes after people. We believe that—and I’ve made sure that the Rife people and the others understand that—an indictment is imminent; these are criminal charges.

This is just now beginning, criminal indictments, out of San Diego.

Now, the reason for San Diego is because there are a lot of Rife people who operate out of there. There are the Mexican clinics, across the border, which attract attention. So, there’s going to be a big push to shut-down alternative practitioners in the San Diego area. And there’s going to be arrests, indictments, seizures, the whole thing.

They’ve already seized stuff from these people [*Jim Folsom*], and I made it clear to them that they better plan on an indictment. They have not hired me, yet. I would help them with a strategy to defeat it. I have no problem working with them. I am talking to them about it.

My recommendation to them is that they adopt a very hard-nosed strategy about this, and it goes something like this:

When a pharmaceutical company brings a new drug to market, it costs them anywhere between \$50 and \$100 million dollars of testing to get it approved through the FDA. The system has been set up with the FDA to make it cost this much. They demand this kind of testing on a new product. What the FDA and the FTC together are saying here, through Operation Cure-All, is that unless you’ve got \$100 million bucks, you can’t play in this game.

The system has been set up to favor only the richest of the rich, and that means the drug companies. And I consider that system to be bogus.

So, what happens for me here is, my advice to the Rife people is: marshal your forces; get your words together; there is another way of proving that what you are doing is right. Let them take you to court,

SUBSCRIBE TO *The SPECTRUM*

Our subscription rates are as follows:

6 issues = \$25 U.S. / \$30 Canada / \$35 Foreign

12 issues = \$45 U.S. / \$55 Canada / \$60 Foreign

(Note: All prices are in U.S. dollars.)

Please call for bulk subscription rates.



To order by credit card:

Call toll-free (U.S. & Canada): **1-877-280-2866**

Otherwise call: **1-661-823-9696**

~ OR ~



Send Check or Money Order to:

The SPECTRUM

PO BOX 1567

Tehachapi CA 93561

Federal Court. It will cost you a whole lot less. They will try to block the evidence; they’ll try and block the argument; they’ll try to do it all. But, make them do it.

Go ahead; do the campaign in two ways: one, through public opinion; and the other, through this right here. And that’s exactly what we’re talking about, how to deal with it. It’s happened before; they’ll try and exclude information. But, basically, what they’re going to say is that all of this is fraud.

The answer is: This is NOT fraud! This technology has been around for a number of years; it’s time to stop the suppression! That’s the defense.

You know why? Because it’s true!

It’s time to stop the suppression of these things, not just all electro-medicine, which is a big thing, but a lot of our other things that have been suppressed, like oxygen therapies.

Why the suppression?

They’re cheap; they work extremely well. They’re being used around the world.

Is there any other research being done on electro-medicine like Rife?

Oh YES! A huge amount of it is being done, both underground and above ground, on planet Earth.

We can no longer, in this country, claim to be the do-all, be-all of medical care. Frankly, our medical system here is the 3rd largest killer of Americans. We know that to be true. What in the hell are we protecting it for? We should be attacking it left and right.

So, consequently, those people who are trying to find answers are under fire by our government. Well, that’s got to quit! And I’m making these noises, and I’m a conservative Republican from Orange County. I want this to quit, right now!

This isn’t a matter of: “Please, would you think about making it quit?” I want to know, from our government: What is your point in putting this out of business? I want the suppression stopped, right now! And I want the people who are behind the suppression placed in a nice federal prison!

Martin: It’s been the Big Boys all along. How far it will go in the Federal court system remains to be seen.

Bolen: There’s more happening. There are a lot of attacks going on nationwide. I know because that is my business and I have clients everywhere. Some of them are confidential, and I’d like to be able to leak it right now, but I can’t. There’s a lot happening. Ones like the Quackbusters, and their federal friends, are after them all.

You know, the Quackbusters have been after Hulda Clark for a long time.

Martin: She’s fine, now, isn’t she?

Bolen: No, they still are at it. They maintain some lawsuits. They’re just trying to drain-off her finances so she can’t continue her research.

Martin: That’s the way they do it.

Bolen: The problem with that is, we’ve been designing ways to get back at them.

I tried, about a year and a half ago, to get the Rife people interested. I knew something was coming because of my

other projects around; I hear things. They didn't listen to me. They decided as a group, the Rifers around the country, that they felt they were doing just fine staying below the radar, and that they would be ok.

I said: "You're wrong and you're about to find out, sooner or later." Sure enough, I was right.

It's like nobody wants to be the first one to test this in California. But we passed SB 577 here [see early in this article]. If you'll read that bill, it makes it ok for homeopaths, naturopaths, nutritionists, etc., to do whatever it is they want to do. That's the law that was passed this last year—in fact, unanimously, both houses, and the governor signed it. So, we've got an impressive lobby here.

Martin: The foundation has been laid.

Bolen: My trouble is, the way I see it around the country, the Health Freedom Movement is kind of like a Celtic army. The Romans defeated 480,000 Celts with 78,000 Roman troops in France, way back when. And the reason was, the Romans were very organized, and the Celts couldn't get together. So, I've learned from that. That's all it takes is organization. But the thing is, the Health Freedom Movement is so huge in this country that they really ought to win, easily—except they don't communicate.

Here's the thing. I don't mind you quoting me on this:

The suppression issue is the biggest health issue we have in America. Since health is such a big problem right now, it makes it one of the top issues in America. To me, and to others who are insiders, the suppression issue is killing Americans.

I want to find out who's behind it, and I want something done about it. I'll do something about it. It's not going to happen on its own. What do we do?

Martin: Going through the legal system is one approach. It's time consuming, and it's expensive.

Bolen: What happens is, people say: don't use the legal system because it doesn't work. My thing is: listen, I'm in a war. It takes all kinds of attacks to win a war!

Martin: That's right. And it's the system we have in place.

Bolen: It's the system we have in place; that's right.

Martin: Not only that, you're sending a message—big time!

Bolen: You bet! That is the message that we intend to send!

[end quoting]

And that's the kind of organized front which eventually sent the British back to England at the time of the Revolutionary War!

Let's turn to an article written some time ago by Tim Bolen which provides background on the subject of the Quackbusters:

[quoting]

Quackpot Watch:

The Last Days Of The Quackbusters

Opinion By Consumer Advocate
Tim Bolen

I've been following the activities of the "Quackbusters" for about five years, ever since the name Stephen Barrett (www.quackwatch.com) came up, as a player, against a client of mine in California. I asked the question: "Why would this group be using a doctor from Pennsylvania as their witness, when there are 300,000 health professionals in this State?"

Thus began my education. Now I'm going to educate YOU!

The "Quackbuster" operation is a conspiracy. It is a propaganda enterprise—one part crackpot, two parts evil. It's sole purpose is to discredit and suppress, in an "anything goes" attack mode, what is wrongfully named "Alternative Medicine".

It has declared war on reality. The conspirators are acting in the interests of, and are being paid directly and indirectly by, the "conventional" medical-industrial complex.

Millions of health freedom fighters, and members of the public, worldwide, know what I know. Public outrage and reaction is growing. After 25 years of unopposed success, the "Quackbusters" are now in real trouble. "The end" for them, has begun. They, themselves are being hunted.

The "Quackbuster Conspiracy" is in a desperate place now. They know they've lost the war, and are going to pay a terrible price for their actions. The fear is in their eyes.

Crackpots?

Yes. When the self-named "Quackbusters" stumbled around to find a derisive name to call their victims, they picked the word "Quack" without ever bothering to discover its origins. Its original meaning, from Europe, comes from the term "quacksalver" which was used to describe dentists who were dumb enough to use mercury (a poison) as fillings for teeth. Look at propagandist and Quackbuster kingpin Stephen Barrett's website (www.quackwatch.com), and you'll find that HE IS IN FAVOR of mercury amalgam tooth fillings. Barrett,

his cronies, and minions, are not known to do intelligent research.

Evil?

Yes. The "Quackbuster Conspiracy" was started shortly after the American Medical Association (AMA) lost the court battle to the chiropractors in a case begun in federal court in 1976. The federal judge ordered the AMA's covert operation shut down—and leave the chiropractors alone. The AMA files, library, etc., ended-up in Stephen Barrett's 1,800 square foot basement in Allentown, PA. Barrett and his minions had the common sense to stay away from criticizing chiropractors for quite some time. Barrett has since abandoned that common sense.

Federal judges have a way of enforcing their decisions using shackles, federal marshals, the federal prison facilities, asset seizure, etc. Even Barrett, in all his incredible arrogance, isn't dumb enough to match wits with a federal judge. I think the Chiropractic Association should consider re-opening the Wilks case in front of that same federal judge—and point right at Barrett and his cronies.

In that early educational case for me in California, Stephen Barrett and two slime-ball investigators from the California Medical Board had convinced members of the Laguna Beach Police Department that a nutritionist using ozone therapy was "a sex criminal preying on women". Flak-jacketed thugs screwed a gun into Salvatore D'Onofrio's ear, forced him to lie on the ground, and thus began a brutal, anything goes, persecution.

D'Onofrio's attorney was a hiking partner of mine, and told me the story on a ridgeline, seven miles up from a trailhead. I laugh now when I remember my naive response: "This can't be happening in America!"

Sal D'Onofrio, through his attorney, hired us, at day 43 in solitary confinement in the Orange County Jail. He was in "solitary" because that's what they do with sex criminals. He was in jail because the judge had set bail at \$500,000, an amount his supporters couldn't raise. Barrett's minions were ruining D'Onofrio's life in the press.

We organized a bail hearing for day 48 of incarceration, put 62 of D'Onofrio's supporters in the courtroom, LA network television in the jury box, got the front page of the *Los Angeles Times*, etc.,—and the judge let D'Onofrio out on his own recognizance. Seven weeks later, the prosecutor dropped the charges.

Who are these people who would, so casually, inflict that kind of nightmare on an innocent man?

James Carter MD's authoritative book *Racketeering In Medicine*, published by Hampton Roads, carefully explains the Quackbuster Conspiracy.

Alternative Medicine?

"Alternative Medicine" is defined as any protocol, action, or therapy that isn't "drugs, radiation, or surgery oriented".

Wrongfully named? Yes.

So-called "alternative medicine" is actually the health choice of planet Earth. It is a combination of every good health idea invented by mankind, in every country and culture on this planet. There is nothing "alternative" about it. Labeling planet Earth's health choice as "alternative" is, and was, a propaganda device.

North Americans have overwhelmingly (by their purchases) made "Alternative Medicine" the "health choice of the people"—for the best of reasons: it works better than allopathic; it "removes the cause" rather than "treating the symptoms"; it is cost effective; it makes people feel better and think clearer; and it doesn't have all those horrible side-effects of invasive surgery or prescription drugs.

More than half of the U.S. health dollar in 1999 was spent on "Alternative Medicine" and it was all out-of-pocket. Conventional medicine is being paid for, and is surviving, only because insurance and Medicare pay for it; the public won't spend an out-of-pocket nickel on it.

Alternative Medicine philosophies fit the American way of thinking. ("I'll make my own decisions!") Allopathic Medicine philosophies fit the Germanic way. ("Follow my orders!")

"Alternative Medicine" is for people who think for themselves—Americans.

The door to real "alternatives" is barely open. The future of medicine is right in front of us. It isn't in pharmaceuticals; it is in nutrition, body cleansing, prevention, oxygen therapies, and energy medicine—all of which are constantly targeted by the sleaziest of the "Quackbuster" soldiers.

The "Quackbuster" Stronghold

The Federation of State Medical Boards (FSMB) is a vital medical doctor (MD) control point. It is the trade organization of all 50 States' medical boards. The FSMB is the organization that writes the policy manuals, and provides training for, medical board investigators and prosecutors all over the United States. The FSMB is the Quackbuster police agency.

The Quackbusters use the FSMB to

HEALING CODES VIDEO Set (4-hours)

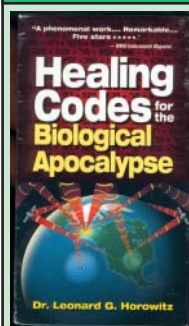

VIDEO Tape set:
\$39.95 (+S/H)
Code: HCBVA (1 lb.)

Could bioelectric technologies investigated during the Cold War provide the most advanced form of killing, enslaving, and coercing billions of unsuspecting people worldwide? More frightening: could infectious agents, including the "mad cow disease" protein "prion" crystal, have been engineered to effect a new insidious level of bio-spiritual warfare?

Dr. Len Horowitz investigates 2000 years of religious and political persecution and the latest

technologies being used to enslave, coerce, and even kill billions of unsuspecting people.

This work returns the most precious spiritual knowledge and "healing codes" to humanity. It offers hope for the loving masses to survive the worldwide plagues, famines, and weather changes that are now at hand. *Healing Codes* presents an urgent, monumental, and inspired work that will be hailed for generations to come.

SEE NEXT-TO-LAST PAGE FOR ORDERING OR CALL TOLL-FREE: 1-877-280-2866.

persecute two groups: (1) "Alternative Practitioners" within the MD ranks (they treat them like traitors); and (2) non-licensed alternative health professionals (they charge them with "practicing medicine without a license").

The Quackbusters, through the FSMB, have been able to change the focus of prosecutions against "bad doctors". They define "bad doctors" as those who use alternative modalities—and maximum penalties are exacted. We have seen in California that real "bad doctors"—those who kill their patients—actually get off with a slap-on-the-hand by using the defense "but I prescribed a lot of drugs".

State medical boards are not serving the needs of we-the-people; they are serving the needs of the Quackbusters and their paymasters.

Medical board prosecutions are funded by the States [taxpayers]. Barrett and his slime artists don't have to spend a dime. I couldn't even count the number of "alternative medicine" practitioners currently under persecution from mis-informed medical board investigators and prosecutors. The damage done to Americans from this attack is incalculable.

Barrett's Dubious Claims About What "Health Fraud" Really Is

The U.S. government has indicated that "health fraud" is a major problem in the United States healthcare system. Statistics show that "conventional medicine" rips off the American public significantly each year in bogus billings, false claims, unnecessary procedures, and tests, etc.

[Former] Attorney General Janet Reno has a special nationwide "Health Fraud Prosecution Unit" to deal with this massive problem. The prosecutions are against mega-greedy hospitals, HMOs, ambulance companies, nursing facilities, etc.—all "conventional" medical units,

not "alternative".

But, if you peruse Stephen Barrett's—don't call him doctor, he's not licensed—website, you get the impression that "allopaths" are to be classified somewhere next to archangels, and "alternatives" are snake-oil salesmen, akin to the devil's minions.

Barrett clearly defines, in smirky arrogance, health fraud as "alternative medicine". Huh?

Doesn't Barrett read national statistics on health fraud? Of course he does; he just ignores them. And "Barrett's parrots" at the FSMB mimic their supreme commander's every word in their policy statements. Anyone can read FSMB policy statements, in their entirety, on the web. Just go to www.fsmb.org and start reading. They, like Barrett, define "health fraud" as "alternative medicine" and fail to even mention the real national "health fraud" statistics.

Why The Fear In Their Eyes?

Three Reasons: Exposure, ridicule, and public rage.

1. EXPOSURE: Health Freedom Fighters, tired of the persecutions, and outnumbering the Quackbusters 100,000 to 1, are now watching Barrett and his soldiers carefully. They've decided to put a stop to Barrett and company. Lists are being made of who the Quackbuster conspirators are, what their function is, where they fit into the conspiracy, who they work for, who their associates are, where they live, and what their probable motives are. Their daily activities, as Quackbusters, are being monitored and documented.

Health leaders consider Barrett and company to be running a subversive organization working against the interests of America.

2. RIDICULE: Examination of Barrett's operation proves that the Quackbusters

are a paper tiger. They are a construction with a 25-year-old modus operandi. Their membership is small, they have an even smaller core group, the industry is turning its back on their extremism, and their leadership “public presence” is laughable. Their support network could best be described as pea-brained.

Their “annual meeting” for the conspiracy was held in a Super 8 motel in Missouri. 25 stalwarts attended from, at least, six different plotter groups. Not very impressive.

“Bizarre” Stephen Barrett, his cronies and minions, even labeled two-time Nobel Prize winner Linus Pauling as a “quack”. The American public, in a consumer-driven movement, is rejecting, with laughter and ridicule, Barrett and company’s ludicrous assertions—hence the term “Quackpot” is now used, commonly, to describe the self-named Quackbusters.

3. PUBLIC RAGE: The American public is just now realizing two things: (a) that a good many of those “alternative” things being blocked and suppressed have been around for a long while, but not available to them because of the conspiracy; and (b) that the system to find and put new things in place is corrupt, and works against Americans. Every “cure” since polio has been suppressed, and the proponents of those cures reviled by the Quackbuster conspirators.

Statistics show that every one of those “cures” worked to some extent.

Barrett, his cronies, minions, and henchmen, have every reason to fear public rage. Russian leader Nikita Khrushchev said it best. He said: “We would never invade America, for every American has a gun.”

“You mean my mother didn’t have to die that horribly, or even die at all?” is a question more and more Americans are asking.

[end quoting]

And yes, indeed, the numbers are at least 100,000 to 1 who are awakening to the longtime conspiracy and unconscionable fraud that’s been perpetrated upon the American public by their own government operating as puppets for the big business of medicine.

But people are fed up with such usurpations of basic health freedoms and they’re becoming outspoken in their opposition—particularly people who who are experienced in the benefits of alternative technologies.

Consider the following article from Dr. James DeMeo, Director of Research at the Orgone Biophysical Research Laboratory (P.O. Box 1148, Ashland, Oregon 97520 USA; email: demeo@mind.net). This is

reprinted from *On Wilhelm Reich And Orgonomy, Pulse Of The Planet #4*, 1993: [quoting]

Anti-Constitutional Activities
And Abuse Of Police Power
By The U.S. Food And Drug
Administration And Other
Federal Agencies

In recent years, there has been an upsurge of police activities in the U.S.A., the nature of which most Americans would more readily associate with repressive dictatorships. We Americans have been educated to believe that democracy, due process, assumed innocence-until-proven-guilt, and constitutional protections against illegal search and seizure are the laws of the land.

On paper, these protections are there; but in reality, these basic constitutional rights and freedoms have been gradually and steadily eroded away by new laws, judicial rulings, and bureaucratic decrees.

One of the lesser-known but more significant leaders of this assault on American freedom has been the U.S. Food and Drug Administration (FDA).

Background To
FDA Police-State Activities

As early as the 1950s, the FDA was engaged in aggressively spying on healthcare providers who employed medications and approaches which were not considered “acceptable” by mainstream orthodox medicine. Notably, it was and has been the American Medical Association (AMA) which has dominated ideas within the medical community, as well as nearly all legislation related to health care.

If the AMA dislikes a particular healthcare approach, they work to banish such methods within hospitals, and to suspend the medical licenses of any doctor who employs them. They have often been able to rely upon state licensing boards and legislatures, and even the U.S. Congress, to pass laws outlawing natural healing methods and the non-MD practitioner (such as midwives, herbalists, or acupuncturists). Failing here, the AMA and friends in the drug industry have relied upon their allies in the FDA to aggressively assault the advocates of natural treatment methods.

Many new healthcare discoveries have thereby remained “underground”, never being allowed to flower productively in the light of day. Inexpensive, non-toxic, and unpatentable natural healing methods have never been seriously or honestly

evaluated by the AMA-FDA pharmaceutical-dominated medical establishment. Instead, policemen have been called in to simply arrest and jail the offending practitioners, seize their files, mailing lists, and other property, burn their books, and otherwise trample the *U.S. Constitution* into the dirt.

• Dr. Royal Raymond Rife was crushed when his new microscopical techniques demonstrated the pleomorphic nature of viruses and bacteria. [1]

• Harry Hoxsey’s successful herbal formulas for the treatment of cancer, used in dozens of clinics across the U.S.A. in the 1950s, were stomped into oblivion by an enraged FDA, after Hoxsey refused to sell his formula to Dr. Morris Fishbein, then president of the AMA. [2]

• Max Gerson’s dietary immune-boosting treatments for degenerative disease were criminalized by the FDA at the very time he published scientific evidence and clinical reports on their effectiveness. [3]

Today, none of these treatments are OPENLY used in the U.S.A., but only in clinics south of the Mexican-California border.

The FDA also attempted to ban and burn Rodale’s *Organic Farming And Gardening* magazine as “advertising literature” not covered by the *First Amendment*; many vitamin companies were advertising in it, and Rodale claimed—to the annoyance of the chemical fertilizer and drug companies—that the vitamin and nutrient values of plants were increased by use of natural organic farming methods, thereby improving human health. The FDA lost that case, but Rodale was forced to spend a fortune in legal fees to defend his right of free speech.

Probably the most significant and blatant example of FDA aggression and anti-constitutional activity is the case of Dr. Wilhelm Reich. The Reich Legal Case surpassed the Scopes Monkey Trial in legal and historical significance, as it clearly marked the willingness of the U.S. courts to condone the censoring of speech, the burning of books, the unreasonable seizure of property, and the willful ignoring of written documents presented to judges.

Reich may not have been what one could call a “model legal client”, but **the willingness of the U.S. courts to incarcerate him, burn his books, and in general treat him like a criminal, demonstrated how far legal technicalities and procedural issues had replaced the original intent and spirit of the law. Certainly all the various judges who reviewed Reich’s case and**

ruled against him, from the local and district court judges, to the U.S. Supreme Court judges, knew they were agreeing to censorship of speech and to the burning of books.

[Editor's note: A superb article on Dr. Wilhelm Reich appears elsewhere in this issue of The SPECTRUM in conjunction with the theme of this front-page feature story.]

The judges also demonstrated no interest in any of the technical or procedural issues which would have weighed in Reich's favor, such as the fact that the prosecutor was himself Reich's former personal attorney, or that Reich had submitted documents (his "Response to Ignorance") to the lower courts which were, essentially, thrown into the trash. Indeed, the deep significance the courts gave to procedural technicalities in his case was exclusively to those matters which worked AGAINST Reich. Clearly, they were out to "get Reich", no matter what.

On the basis of legal technicalities, his many books and research journals were burned in incinerators by court order, and both Reich and a co-worker, Dr. Michael Silvert, were sentenced to over a year in prison. Reich died in prison, while Silvert committed suicide shortly afterward. Other FDA violations at the time included the warrantless invasions and searches of the homes of people peripherally associated with Reich. In one such case, a home was searched and Reich's books were confiscated from private bookshelves. School teachers and doctors who worked with Reich were fired from their jobs, in a manner reminiscent of the more purely political repressions of that time, the McCarthy period.

The Reich Legal Case has been discussed in detail elsewhere [4], and so will not be repeated here, but its importance lies in the fact that the FDA was able to commit severe anti-constitutional actions—indeed, MURDEROUS actions, against an internationally-known and respected scientist without so much as a peep of protest from the various academic "scholarly societies", "civil liberties", or "free speech" groups, etc. **This lack of significant social protest was an encouragement and green light of approval to nearly every federal agency wanting to shape public or private behavior to one or another government policy.**

[Editor's note: So, once again, when people finally wake up enough (usually through personal experience) to ask where their freedoms have gone, the answer is: stolen, one small step at a time,

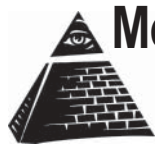

Money And The Conspiracy Of Evil Conspiracy Con 2002 Lecture (2 hrs.) By Eustace Mullins

Sixty years ago Eustace Mullins was a protégé of literary giant Ezra Pound, who understood central banking and its relationship with world unrest. He has been a respected researcher for over 50 years, and has since authored many books on conspiracy, including *Secrets Of The Federal Reserve* and *The World Order*.

Using his recent travel experiences and Orwell's 1984 as examples, Eustace discusses the irony of Homeland Security and how Americans are now treated as "Enemies of the State". He then describes the real manipulators behind all major wars, the Cold War, the Stock Market, the Medical Scam, 9/11, terrorism, and more.

SEE NEXT-TO-LAST PAGE FOR ORDERING OR CALL TOLL-FREE: 1-877-280-2866

To accomplish all this, the "perpe-traitors" control the government, the schools, and the media, while keeping us in unimportant jobs, and stealing most of our earnings. For these purposes the Central Bank is the only mechanism that works. Without the government-granted license to print money, the conspiracy would be no more of a threat to us than bin Laden actually is.

Eustace gives a history lesson you won't forget—nor should you!

VIDEO TAPE: \$20.00 (+S/H) Code: EMV (0.75 lb.)

AUDIO TAPE: \$10.00 (+S/H) Code: EMA (0.5 lb.)

while you were busy waving the flag and pretending that all is well.]

While blatant political repression of politicians has declined over the years [*because they're now more effectively bought-off before ever being placed in the public arena*], with increasing protections afforded to political speech, the political repression of unorthodox scientific discoveries related to health and sickness has not declined at all. In fact, repression of non-political speech has increased, especially when it is linked with concrete marketplace activities which conflict with official government policies or big business monopolies.

In the years since Reich's death, constitutional protections against illegal seizure of property, assumed innocence-until-proven-guilt, and due process of law have been flagrantly violated and trampled into the dirt by the FDA leaders and field agents, who are increasingly teaming up with other arms of the federal bureaucracy to increase their power.

Numerous medical pioneers have been assaulted and personally destroyed, in a manner so blatant and aggressive it makes Reich's treatment by the FDA appear almost gentle by comparison. The FDA's police-state activities are taking place all across the U.S.A., but little of it is being reported in the mainstream media—or if so, generally with biased justifications given for the FDA actions, that "the FDA is combating health fraud" or "medical quackery". Here, the reader will be informed of more recent assaults by the FDA against the natural health movement.

The AMA/FDA/Pharmaceutical Cartel

Increasingly, health care decisions in the U.S.A. are being mandated by small

cadres of "specialists" who decide whether this or that medication will be made legal and available to the American public. Where scientific evidence once was the criteria for extended use of a new medication, such decisions are today being made more on the basis of the profits which can be made from a particular medication.

Too many of the top physician-bureaucrats working in the FDA, National Institutes of Health (NIH), American Cancer Society (ACS), etc., are themselves often drug-company millionaires, with personal stock holdings or investments in the companies whom they regulate. Drug companies provide large sums to political campaigns so as to definitively influence legislation, and to various medical institutes to "research" their products. Their full-page color advertisements for new drugs in medical journals essentially pay for those publications.

Pharmaceutical companies are one of the highest profit-margin industries in the U.S. who do not have to account for the often extreme prices they charge—higher than anywhere else in the world. Drug company money plays a powerful role in shaping health policy, the approval process for new patent drugs, and publishing (or censoring) research findings about the effectiveness or side-effects of those drugs.

Additionally, nearly every major medical organization and medical society in the U.S.A., to include many governmental agencies like the FDA, NIH, and ACS, expend significant sums of money each year to fund unfactual, even slanderous propaganda against relatively inexpensive natural healing methods, which might otherwise substitute for the

expensive and often toxic medications and surgical procedures pushed by the medical-pharmaceutical cartel. “Quack-busting” groups, such as the National Council Against Health Fraud, team up with various medical societies, licensing boards, and the FDA to efficiently snoop upon and “police” the medical community, making sure that only the most orthodox medical treatments will prevail.

Word quickly spreads, through the medical gossip system, if a doctor does not prescribe the usual drugs or treatments. Any doctor employing vitamins, herbs, nutrition, energetic medicine (homeopathy, [Wilhelm Reich’s] orgone accumulator), chelation therapy, or any other progressive, innovative, or unorthodox treatment can expect great pressure from these groups, up to and including visits from aggressive, gun-waving “healthcare” policemen.

Similar, or even more aggressive, treatment is meted out to midwives, herbalists, or to other healthcare providers who lack the MD degree, and employ methods which compete with the entire lucrative doctor-hospital system. A doctor or midwife who is today labeled a “quack” in the newspapers can expect as bad and unfair a treatment as did a “witch” in the Middle Ages.

The quite telling consequences of this anti-scientific pogrom against the new and unorthodox health research findings are that a higher percentage of people are dying from degenerative illness today than in the 1950s, while cancer cure and survival rates are essentially unchanged from when the multi-billion-dollar orthodox “war” against cancer was initiated. [5]

Like the “wars” against crime, poverty,

and drugs, the “war against cancer” has been a huge, expensive flop, benefiting only the over-bloated cancer industry. Today more people are engaged in the “treatment” of cancer than those who die from it in a given year. Obviously, the attitude that “war” is necessary to solve a social or healthcare problem is itself part of the problem, and not part of the solution.

[Editor’s note: And for you astute SPECTRUM readers, that “war” attitude provides a big clue about how far up the Pyramid of Power resides those really in control of this whole FEAR-based medical fraud. Another clue would be that “their” agenda includes extensive depopulation of planet Earth without alerting the public that anything particularly sinister is going on. And, hey, if “their” willing puppetry can make a buck in the process, all the better for keeping the REAL agenda on track!]

Increasing Use Of Swat Teams & Seizure Laws

One clear consequence of the widespread “war” approach to social problems has been the growing use of police Special Weapons and Tactical (SWAT) teams to enforce bureaucratic decrees by federal agencies, even those agencies one normally does not associate with “law enforcement”.

In recent years, the [superb] farm journal *Acres, USA* [6] has exposed numerous examples where individual farmers, who were making legal challenges to U.S. Department of Agriculture (USDA) rulings about crop quotas or loan-security arrangements, had their homes, land, and farm equipment SEIZED at gunpoint by the

USDA. A few farmers have been shot dead.

[Editor’s note: And as was briefly alluded to earlier, those farmers wanting to run their farms along natural, chemical-free and pesticide-free, “organic growing” guidelines—much healthier for the farmer, the farm, and the consumer—have experienced a mountain of obstacles. So too (as was earlier briefly mentioned) has such organizations as Rodale’s popular Organic Gardening magazine (and Rodale Institute, near Emmaus, Pennsylvania), which has been promoting natural techniques since their first (May 1942) issue, as the lucrative “chemical agriculture” push began by ones likewise controlling the pill-pushing business. Was it really an “accident” that founder J.I. Rodale’s son and then-Editor-In-Chief Robert Rodale died in an auto crash in 1990 during a trip to Moscow?]

Legal and constitutionally-protected citizen opposition to federal government policies has been met by increasingly aggressive and militant reactions by policemen—armed with machine guns, flak jackets, concussion grenades, and even tanks. The message is: Obey, Or Else!

The USDA, Bureau of Alcohol, Tobacco and Firearms (BATF), Drug Enforcement Agency (DEA), and even the U.S. Forest Service (USFS) have all developed well-armed “security forces”, equipped with Special Weapons and Assault Tactical (SWAT) teams, armored personnel carriers, military-style attack aircraft, and other forms of sophisticated weaponry which flagrantly defy the constitutional ban against the use of military forces for domestic law enforcement.

Hundreds of millions of dollars in property—to include homes, automobiles, cash in bank accounts, and other personal and business property—has been seized by these various agencies, who often work in coordination with the FBI, Internal Revenue Service (IRS), U.S. Customs Service, and U.S. Postal Service.

Surely, some of this military weaponry is genuinely used against organized crime and illegal drug traffic. But it surely does not stop there, and it is precisely the spill-over of such methods against ordinary civilians who break some petty or technical rule of federal bureaucracy, or civilian dissenters to federal policy, or even only unorthodox medical practitioners, which makes it all so dangerous.

The various “War on Drugs” seizure

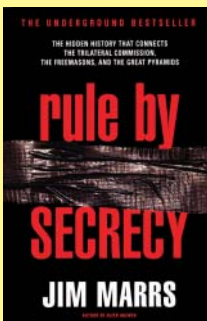

THE UNDERGROUND BESTSELLER
THE HIDDEN HISTORY THAT CONNECTS
THE TRILATERAL COMMISSION,
THE FREEMASONS, AND THE GREAT PYRAMIDS

rule by
SECRECY

JIM MARRS

RULE BY SECRECY: The Hidden History That Connects The Trilateral Commission, The Freemasons, And The Great Pyramids

BY JIM MARRS

In this astonishing book, celebrated reporter and *New York Times* bestselling author Jim Marrs painstakingly explores the world’s most closely guarded secrets, exposing clandestine cabals and the power they have wielded throughout time. Defiantly rooting out the truth, he unearths startling evidence that the real movers and shakers covertly collude to start and stop wars, manipulate stock markets and interest rates, maintain class distinctions, and even censor the six o’clock news. And they do all this

under the mindful auspices of the Council on Foreign Relations, the Trilateral Commission, the Bilderbergers, the CIA, and even the Vatican.

Drawing on historical evidence and his own impeccable research, Marrs carefully traces the mysteries that connect these modern-day conspiracies to humankind’s prehistory. The eye-opening result is an extraordinary synthesis of historical information—much of it long hidden from the public—that sheds light on the people and organizations who rule our lives.

Disturbing, provocative, and utterly compelling, *Rule By Secrecy* offers a singular worldview that may explain who we are, where we came from, and where we are going.

\$15.00 (+S/H)
Code: RBS (1.0 lb.)

SEE NEXT-TO-LAST PAGE FOR ORDERING OR CALL TOLL-FREE: 1-877-280-2866

laws, for example, have allowed various government agencies to “seize and impound” (STEAL!) the property or cash money of any citizen, based upon MERE SUSPICION that the property or money was acquired from sales of illegal drugs. A citizen whose property which has been seized must post a significant cash bond to the courts (a percentage of the value of the seized goods), and then go to court and “prove their innocence” to the judge before the property is returned. Failing to do so, the “law enforcement” agencies which made the seizure are then allowed to auction off the seized properties and keep a percentage of the money for “internal use”!

For example, there was the case where a large fishing boat was seized by the DEA during a “routine” U.S. Coast Guard inspection, when one of the deck hands was found to have marijuana cigarettes in his pocket. The seizure of the expensive fishing boat destroyed the life’s work of the boat-owner captain, who was held responsible for the concealed actions of one employee.

Then there was the case of Willie Jones, a hard-working gardener who paid cash for an airline ticket, not knowing that airline ticket agents often provide “tips” to policemen about travelers who pay for tickets with cash. The assumption is that anybody buying an airline ticket with cash is a drug dealer! The cops confronted Jones, and confiscated \$9,600 he was carrying for purchase of shrubbery for his landscaping business; he was flying to a gardening convention to purchase plants for next year’s work. Although the cops “arrested” his cash, Jones was never charged with anything, and he did not have additional money to go to the courts to “prove his innocence”. So the cops just kept the money. Jones observed: “I didn’t know it was against the law for a 42-year-old Black man to have money in his pocket!”

In another remarkable case, two gardening supply stores, along with inventories and bank accounts, were seized by DEA agents after an employee advised undercover agents how grow-lights might be used for indoor cultivation. Marijuana was implied, but never mentioned explicitly—but so what! The DEA felt the selling of grow-lights was contributing to the drug trade, so they raided the stores.

Now, this is purely legal stealing, where the activities of the cash-greedy federal agents and judges is not supported by anything written in the *Constitution*, nor by any other moral or rational premise. Indeed, in fully 80% of

the cases where assets are seized by the U.S. government under the forfeiture laws, NO ONE IS CHARGED WITH A CRIME OF ANY SORT. [7]

Even the U.S. Environmental Protection Agency has gotten into the act of creating its own police force SWAT teams. They recently raided an insectary which was legally challenging the need to obtain “EPA permission” to sell lady bugs to organic farmers.

In another recent disgusting example, when the National Park Service (NPS) wanted to purchase a large plot of land adjacent to a National Park in southern California, the elderly owner, Mr. Donald Scott, refused to sell. Angered, NPS officials teamed up with the IRS and DEA and went snooping for dirt on Mr. Scott “to see” if he was growing pot on his property. One of the NPS agents then conveniently volunteered that he had seen “pot plants” when flying overhead many hundreds of feet up in a helicopter (!), and somebody else received an “anonymous tip” that Mrs. Scott was seen purchasing items in town with hundred-dollar bills. With this fabricated “evidence”, they raided Scott’s rural mountain home with SWAT teams and gunslingers, with the expectation that—if drugs were found—they could confiscate his home and land, and whatever money he had in the bank, which would then become the property of the various “law enforcement” agencies.

As they burst in on Scott’s mountain home early in the morning, Mrs. Scott screamed with alarm at the sight of guns being pointed at her by strangers. Still dressed in pajamas, Mr. Scott jumped up from his bed with a pistol in his hand to defend his wife against intruders. With his pistol pointed to the ceiling, he was shot dead in his own home by the cops, at the very moment when he was complying with police orders to put the gun down. No drugs of any kind were found on the property. The entire raid was staged purely for the purpose of stealing the man’s land, and placing it on the auction block! [7]

These are just a few incredible examples, from HUNDREDS TO PERHAPS THOUSANDS of similar cases, of federal assaults upon ordinary citizens who were never charged with a crime, as more political powers and guns are accumulated into the hands of our unelected federal bureaucracy.

And, of course, there were the events in Waco, Texas, where a fundamentalist religious group was needlessly assaulted by swarms of federal and state police, and Bureau of Alcohol Tobacco and Firearms (BATF) agents armed with

automatic weapons and tanks, leading to nearly 100 deaths (including over 20 children). [8] The incident at Waco was undertaken for allegations which were no more severe than what has been routinely certified and documented as occurring within more established religions (such as child sexual abuse by Catholic clergy). By contrast, no Catholic church or school has ever been invaded by BATF or Health and Human Services (HHS) agents, snooping out “alleged child sexual abuse” at the point of a gun.

A recent Congressional investigation into the Waco massacre suggested the allegations of “child sexual abuse” had been concocted, after-the-fact, by [then] Attorney General Janet Reno, to justify her approval of the shockingly aggressive raid.

These examples are only a few, from many, of clear and growing evidence of the decline of respect for constitutional principles and due process of law—not by ordinary citizens, but rather, by out-of-control, power-hungry government leaders and bureaucrats, stimulating the growth of an American Police State.

Increasingly, these various federal police forces are coordinated through larger and larger computer data banks on ordinary citizens. With poverty and homelessness on the rise, with more and more of the public wealth, lands, resources, and means of production owned and controlled by fewer and fewer people, and with new reforms blocked by both political barriers and bureaucratic immobility, it is not surprising to see an increase in social chaos and crime.

But the public clamor has unfortunately NOT been to address the root causes of crime, or even to hold the guilty federal leaders accountable for their autocratic, indeed fascist, conduct. Rather, with the news media nearly silent about these various assaults upon democracy and freedom (or with the media uncritically parroting only the federal “party line”), the cry from Washington DC is for even MORE police “protection”.

And so, new legislation is making its way through Congress, supported by both conservative Republicans and liberal Democrats, to grant even more police powers to the various federal agencies, and frighteningly, to centralize their activities under a single anti-crime umbrella.

This is the background against which the AMA/FDA/Pharmaceutical cartel has turned up the heat against healthcare reformers, midwives, physicians employing natural healing methods, and vitamin and herb companies.

Growth Of Natural Healing Methods In The U.S.A.

According to a recent study in the *New England Journal Of Medicine* [9], about a third of all American adults use unconventional medical treatments, such as chiropractic, therapeutic massage, relaxation techniques, special diets, and megavitamins. Americans are increasingly attracted to non-toxic natural healing methods, as an alternative to the cut, burn, and poison methods of allopathic medicine.

In recent years, there also has been increasing evidence that vitamins and other items advocated by “healthfood nuts” do indeed work to prevent degenerative diseases, and to promote recovery and remission from severe illness. Health reformers are increasingly advocating natural healing methods, including natural childbirth, home birth, breastfeeding of infants, and organic fruits and vegetables.

Vitamins A, B, C, and E, in moderate to high doses, are increasingly being found to reduce one’s risk of heart disease, cancers, and other degenerative diseases. Indeed, the National Institute of Health, in response to growing pressure from the public, recently opened an “Office of Alternative Medicine”, and has started to fund investigations of natural healing methods. [10]

The percentage of Americans attracted

to natural healing methods is growing and threatens the economic monopoly of Big Medicine, the AMA/FDA/Pharmaceutical cartel, which has for many years dictated healthcare approaches used in the U.S.A. with an iron fist.

This appears to be THE major reason for the intensification of the FDA’s vicious and murderous war against the natural health movement. The Director of the FDA, under both the Bush and Clinton Administrations, is [was] Dr. David Kessler, a powerful bureaucrat who epitomizes what Wilhelm Reich meant by the term HIG (Hooligan In Government). Kessler has intensified efforts by the FDA to control what is said, published, used, or sold in all aspects of healthcare in the U.S.A. He has established a “snitch” telephone hotline whereby “responsible doctors can call in and report any of their colleagues engaged in unacceptable, unorthodox, or deviant medical practice”.

A blatant double-standard is applied: natural health advocates are assaulted for legal technicalities or for no reason at all, while big pharmaceutical and surgical device companies can literally get away with murder. Nutritional supplements with proven benefits are banned without evidence of any public health hazards, while synthetic pharmacological drugs or horrific surgical devices which have never been proven effective, are approved in spite of demonstrated deadly side-effects.

Even when evidence is found that the pharmaceutical companies completely fabricated their FDA-approval data out of thin air, nothing is done; the FDA turns a blind eye in such cases.

Some examples [1993]:

- The FDA has received over 5,500 complaints against Aspartame (NutraSweet), which was legalized amid controversy regarding the capacity of this substance to alter brain hormone balances; some 9% of the complaints today involve serious neurological effects, including seizures.

- A recent major study by UCLA researchers of 109 patent-drug advertisements found 81% to be “inaccurate, misleading, and even dangerous.” [11]

- A General Accounting Office report found that 51.5% of patent drugs approved by the FDA between 1978 and 1986 had “serious post-approval risks” not disclosed on originally-approved package inserts, including “heart failure, myocardial infarction, anaphylaxis, respiratory depression, convulsions, seizures, kidney and liver failure, severe blood disorders, birth defects, and blindness”. [12]

In spite of these and many other deadly problems associated with costly “FDA-approved” patent drugs and medical devices, you never read about a major pharmaceutical company being raided with SWAT teams, their bank accounts seized, with offices, laboratories, and homes of officers being raided and ransacked at gunpoint, or their drug inventories being confiscated and impounded. Nor has the FDA taken any actions against the blatant advertising of drugs within medical journals publishing papers purportedly evaluating the efficacy and safety of those same drugs.

[Editor’s note: *It got so bad by a few years ago that the conscience-stricken MD who was then the Editor-In-Chief of the New England Journal Of Medicine quit her job. But not before she courageously published an astonishing editorial summarizing rampant cheating and corruption like that noted above—and more!*]

But such repressions and police actions are being taken against natural healing clinics and smaller laboratories all across the U.S.A. for doing nothing more than manufacturing, selling, or prescribing vitamins, aloe vera, herbs, and other non-toxic food substances. Witness the following recent examples:

1. (1987) Ft. Lauderdale, Florida:

Based upon a perjured search warrant, the Life Extension Foundation, a non-profit organization supplying

9/11: THE GREAT ILLUSION

End Game Of The Illuminati. Our Choice: Fear Or Love?

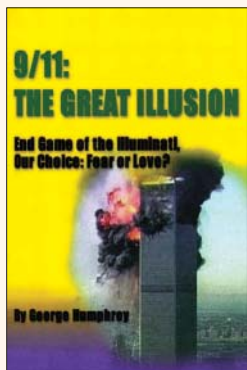

NEWEST BOOKLET BY GEORGE HUMPHREY

[Excerpts from the author’s Introduction:] Though I knew in my heart from day one that the 9/11 WTC/Pentagon assault was a staged event, I told myself that I would not write another booklet. Plus, I had had one too many conversations with dear and educated friends who had gone absolutely ballistic when even the concept that anything other than the reported “news” could be behind this episode.

However, as I listen to the media and their 24/7 frenzy of hateful misinformation, I knew it was time to act. This booklet is not for everyone. But it is for those who love their country and have that rare quality called an open mind.

9/11: *The Great Illusion* is intentionally kept short so as many as possible will have access to this material. People must wake up to some cold hard realities: A small occult group—The Illuminati—have been organized for centuries, and have control of our economy, culture, and political organizations. These people have ZERO respect for our

Republic and *Bill Of Rights*. They are behind a vast majority of the wars and revolutions, and are behind the events of September 11th.

This booklet is presenting evidence that goes against everything that the mainstream media and political structure would have people believe.

SEE NEXT-TO-LAST PAGE FOR ORDERING OR CALL TOLL-FREE: 1-877-280-2866

**Free shipping if ordered with any other item from Wisdom Books & Press*

\$3.50 (+\$1.50 S/H)*

Code: TGI (0.25 lb.)

70 Page Booklet

supplements to low-income individuals, is raided by armed FDA agents and U.S. marshals. Breaking down the doors, the agents spent 12 hours seizing every nutrient product, file, and newsletter they could get their hands on, including many personal items of owners and employees. Even telephones and computers were "ripped from the wall". Four years later, another raid took place, after the Foundation relocated to Arizona. Employees were intimidated into thinking they had been "shipping illegal drugs" (vitamins!), but no charges were filed against anyone. The raid took three days to complete. Requests for the return of property were consistently refused. Lawsuits against the FDA are in progress. [13]

2. (1990) Mt. Angel, Oregon:

Nine FDA agents, 11 U.S. marshals, and 8 heavily armed Oregon state police raid Highland Laboratories, kicking in both front and back doors. Over an 11-hour period, virtually everything except tables and chairs were carted off to waiting trucks, including many items not listed on the search warrant, at a total value of \$37,000. Nobody was informed about the grounds for the raid, the "supporting affidavit" being suppressed by the court. The seized property was taken to an undisclosed location. Mr. Kenneth Scott, owner, and other Highland employees were threatened with violence if they attempted to enter the company premises, and the daughter of the owner was held "in house arrest" for 12 hours at a location several miles away.

Highland subsequently reopened, and hired a separate outside mailing service to satisfy FDA requirements. In response, the FDA raided the mailing service, which was a small business run out of the home of a woman in another town. Finding nothing there except mailing equipment and business records, FDA agents threatened to confiscate the woman's checkbooks and cash, failing to do so only after being begged not to. **When she asked them: "Why are you doing this?" the agent replied "Somebody's got to do it!"** Because of the raids, the owner of the mailing firm subsequently closed her business and refuses to file charges out of FEAR OF GOVERNMENT REPRISALS (!). No charges were ever filed by the FDA against anyone, nor has any of the seized property been returned. The FDA still has not given anyone reasons for their outrageous tactics, which were designed simply to put the firm out of business. [14]

3. (1990) El Cajon, California:

The FDA attempts to railroad Sissy

Harrington-McGill, 57-year-old owner of a pet food store, for violation of a proposed *Health Claims Law* because her literature stated vitamins would help keep pets healthy. Her store was raided and ransacked without a search warrant. When her day in court arrived, Harrington-McGill requested a jury trial. The judge refused her request, dictating that he alone would judge the case. She was tried and convicted of violation of the *Health Claims Law*, EVEN THOUGH IT HAD NOT YET BEEN PASSED BY THE U.S. CONGRESS AT THE TIME THE FDA RAIDED HER, OR AT THE TIME OF HER TRIAL OR CONVICTION. Ms. Harrington-McGill repeatedly informed the federal judge of this fact, but he ignored her complaint. For this first-time misdemeanor "violation" of a non-existing law, she was sentenced to 179 days in prison, with a fine of \$10,000. She was led away in chains and served 114 days in prison before being released after the U.S. Congress refused to pass the *Health Claims Law*. Lawsuits against the FDA have been filed. [15]

4. (1990) Reno, Nevada:

The Century Clinic, which employs chelation therapy, homeopathy, nutritional, and natural therapies, is raided twice by FDA and Postal Service inspectors and other government agents. During the first raid, a 14-page list of items was confiscated even though the warrant itemized only three short paragraphs of materials for seizure. Virtually all equipment, supplies, files, mailing lists, computers, and records were taken during a 16-hour ransacking of facilities. No charges were filed. Century Clinic then recovered, rebuilt their facility, and sued the FDA for return of the seized property.

The FDA responded with a second raid, this time involving searches of the persons, homes, and vehicles of Clinic owners and employees. Patients in treatment at the time of the raid were treated rudely, ordered about, and interrogated. Many were not allowed to leave without giving names and addresses. Cash and checks were also seized, along with another 14 pages of inventory. Again, NO CHARGES WERE FILED AGAINST ANYBODY! [16]

5. (March, 1991) Tijuana, Mexico:

Four armed Mexican police, without warrants or charges, kidnapped Jimmy Keller from his office at the St. Jude Hospital, and took him to their headquarters. There, six men in blue jeans and work shirts who refused to identify themselves (later identified as bounty hunters for the U.S. Justice Department)

seized him and forced him to cross the border to the U.S.A. There, Keller was arrested by the FBI on 12 counts of wire fraud. Keller had made telephone calls across interstate lines to attract people to his Mexican clinic.

Following the illegal kidnapping of Keller from Mexican soil, without extradition, he was jailed in Texas, his bond set at \$5 million. He was later convicted and sent to a North Dakota prison for two years. Keller ran a very successful cancer treatment clinic, which he founded after using natural methods to cure himself of "terminal" cancer. His own cancer had been unsuccessfully "treated" 25 years earlier by orthodox cancer specialists who amputated his ear and mutilated his face. Following the horrific surgery, Keller's cancer returned and metastasized. He investigated natural healing methods, cured himself, and then began helping others to do so. [17]

6. (1991) Texas:

The alternative medical clinic of Dr. Stanislaw Burzynski, an emigre from communist Poland, is raided by FDA and Texas Department of Health agents, following public announcement that Burzynski's successful, unorthodox methods will be evaluated by the National Cancer Institute. Until then, Burzynski had worked quietly for 15 years without any complaints or trouble with the law. [18]

7. (1991) San Leandro, California:

NutriCology, a nutrition supplement company operated by Stephen Levine, Ph.D., a molecular geneticist from the University of California at Berkeley, is raided by 12 FDA agents. Levine spends \$500,000 over the next year to fight three different FDA injunctions, all of which are thrown out of court. No complaints were ever made about the firm. [19]

8. (1992) Kent, Washington:

The unlocked door of Dr. Jonathan Wright's natural medical clinic was kicked in, while FDA agents wearing bullet-proof vests, with drawn guns, pushed into the room, shouting at everyone to "Freeze! Put up your hands!" The raid was in reaction to a recent FDA ban on a contaminated batch of B-vitamins in another state.

Wright was not connected to that particular incident, and did not ever use contaminated vitamins. No matter. Workers were held at gunpoint and his office searched, while computers, mailing lists, books, and files were hauled away in a large truck. Patients were generally treated like criminals. The FDA Gestapo agents spent 14 hours at the clinic, searching through everything.

Dr. Wright is internationally known for

his work on nutritional medicine and preventative health approaches. At the same time, down the street, the For Your Health pharmacy was being raided in a similar manner. This pharmacy serves preventative health doctors in the Kent area. As of mid-1993, none of the impounded equipment, computers, or files have been returned, and NO CHARGES HAVE BEEN FILED AGAINST ANYONE. [20]

9. (1992) San Diego:

David Halpern and several of his family members, as well as the Presidents of three British and one German vitamin companies, are charged with 198 counts of “conspiracy”, “smuggling”, and “violation of the *Food, Drug, And Cosmetic Act*” for importing banned nutritional supplements which are freely available, over the counter, in Britain and Germany. The indictments carry a potential prison term of 990 years in prison. [21]

10. (1992) Texas:

The FDA, working behind the scenes, prompted the Texas Department of Health (TDH) and Texas Department of Food and Drug to undertake raids upon over a dozen large healthfood stores. Over 250 different products, an arbitrary list some 88 pages long, was forcibly seized from shelves. The list includes flaxseed oil, effervescent vitamin C, various herbs, Sleepytime Tea, aloe vera, and zinc products. Following a public outcry, and restraining reactions from Texas politicians, the TDH Gestapo officers threatened one of the ravaged healthfood store owners in the manner of a Mafia extortionist: **“Don’t talk to the press, or we’ll come down on you twice as hard!”** No justifications were given for the inclusion of any of the products

on the seizure list, no charges were filed, and none of the products were ever returned to the stores. [22]

11. (1993) U.S.A.:

Nearly 40 different natural-healing clinics, healthfood stores, and vitamin manufacturers were raided in May and September, in armed commando-style assaults by combined agents of the FDA, DEA, IRS, U.S. Customs and U.S. Postal services. Details on these more recent raids are difficult to come by, but it is reported that, besides seizing various stocks of vitamins, herbs, and other nutritional supplements and compounds (such as shark cartilage), IRS officials seized both personal and company bank accounts, along with automobiles, computers, office equipment, and other valuables. Mailing lists of customers and patients were of particular interest in the seizures. The homes of the company owners and employees were also raided, without search warrants. SWAT teams, armed with machine guns and flak jackets, participated in some of the raids. The Post Office, in turn, acted to illegally block the mail of some of the companies, effectively shutting them off from communication with the public and leaving them without funds, mailing lists, or other resources necessary to mount a proper legal defense. As before, NO CHARGES WERE FILED.

Some shocking examples of Gestapo tactics occurred. At the home of one employee, dark-dressed men with guns demanded entry, but the scared individual refused to let them in; instead, she went to the bedroom to dial 911 for the local police. The door was smashed down and she was shoved to the floor with a gun put to her head.

In another case, a breast-feeding mother

employed at a raided firm was roughed-up and handcuffed for 11 hours while FDA agents ransacked her home.

These latter raids included the clinic and offices of Dr. Kurt Donsbach, author of many self-help nutrition-oriented books widely sold in healthfood stores. Donsbach’s home was also reportedly raided, and his personal bank accounts seized. Also raided were the U.S.A. distributors of German-made Neiper Products, formulated by the internationally-known and respected Dr. Hans Neiper, who operates a successful clinic in Germany, and sponsors the popular health-science magazine *Raum & Zeit*.

Many ordinary citizens were manhandled and threatened with death by gun-pointing government agents during these raids, all for the “crime” of manufacturing, distributing, selling, or prescribing vitamins, nutritional supplements, and related natural health products or methods. [23]

The above are only representative examples from a very long list of similar FDA abuses of power in recent years.

The FDA clearly has become the attack-dog tool of the AMA and pharmaceutical industry, and many FDA field agents are on record as stating that the agency is out to “destroy the health food and nutritional supplements industries”. And that is precisely what they are trying to do.

[Former] FDA Director Kessler wants to control not only the marketing of products, but also what is said in speech or print about health matters. He has vowed to “crack down” even on scientific meetings and conferences which present findings “unacceptable” to FDA policies—and this is no idle threat.

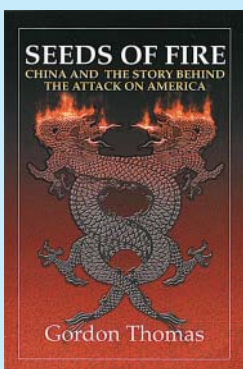

SEEDS OF FIRE: CHINA AND THE STORY BEHIND THE ATTACK ON AMERICA

Seeds Of Fire explains how China will use a crisis to launch itself as a new Super Power—and become America’s new major enemy.

China by 2015 will have deployed tens to several tens of missiles with nuclear warheads targeted against the United States, mostly more-survivable land and sea mobile missiles. It will also have hundreds of shorter-range ballistic and cruise missiles for use in regional conflicts. Some of these shorter-range missiles will have nuclear warheads; most will be armed with conventional warheads.

That prediction is from a CIA briefing paper to the Bush Administration. It is one of almost 100 pages of never-before-published official documents in *SEEDS OF FIRE: China And The Story Behind The Attack On America*, by Gordon Thomas. No one can afford to ignore this book!

SEEDS OF FIRE is a book that every patriotic American — everyone who cares about the future of this country, everyone who wants to know what goes on behind the scenes — must buy and read. This is THE book. Written by a highly experienced intelligence analyst, it is simply a MUST. You cannot ignore the warnings Gordon Thomas gives.

As an example of his total credibility, hours after the book was published, the CIA was forced to confirm its

findings about the threat China poses. The CIA publicly confirmed what Gordon Thomas reveals in *SEEDS OF FIRE*. Just how big a threat China is.

This has been kept out of the news agenda because it does not suit certain business interests to have that truth emerge. But at last here it is. Every patriotic American should buy and read this book! It is simply revelatory.

Other revelations include the Inslaw/Promis “largest global software theft in history”, MK-ULTRA mind-control applications, and the link between newspaper magnate Robert Maxwell and the Los Alamos laboratory nuclear secrets “spy” case.

But it is the China connection that ought to alert all thinking Americans to “the sleeping giant” of the Orient. Be informed. Be astonished.

Price: \$25.95 (+ S/H)
Code: SOF (1.5 lb.)
600 pages

**SEE NEXT-TO-LAST PAGE FOR ORDERING
OR CALL TOLL-FREE: 1-877-280-2866**

Kessler and the FDA are the closest thing to a domestic Gestapo-type police force in the U.S.A., and their power is growing; new alliances are being cemented between the FDA, IRS, DEA, FTC, Customs and Postal Services, HHS, and other government agencies, to “combat the growing menace of health fraud”.

The FDA alliance has destroyed the lives and work of numerous medical pioneers, as outlined above, usually WITHOUT ANY CHARGES BEING FILED. They simply arrive at the offending clinic and home of the pioneer, break down the doors, shove guns into the faces of everyone present, seize and impound office and laboratory equipment, mailing lists, computers, files, bank accounts, etc., carting everything off to a warehouse where it is dumped. Even personal funds in a bank account are “impounded” (stolen!) by these government thugs, whom we may assume are, like DEA agents raiding a crack house, using drug-seizure laws to keep a percentage of whatever they steal!

Amazingly, NONE of the major political parties have displayed alarm or interest in these FDA assaults. It has all been done with the full knowledge and approval of top politicians (Reagan, Bush, Clinton, Gore) and Justice Department officials (Janet Reno). Virtually ALL of these politicians have consistently been sent letters of protest by the lawyers, friends, patients, and co-workers of the various clinicians or small businesses who have been raided. To my knowledge, nobody who has been raided by the FDA has ever received a friendly note or a helpful response from any of our political Royal Family. These power elites either agree with the FDA, don't care about natural health matters, or are completely isolated from what is going on in the real world by layers of bureaucracy and “helpers”, who censor the pleas for help from their mail and telephone calls.

The FDA raids demonstrate a serious erosion in the principles of government by law, due process, liberty, and justice. For health matters, at least, we now have government by iron-fisted bureaucratic decree, with only the façade and illusion of law.

Originally the FDA was formed under the mandate of the *Pure Food & Drug Act*, which simply required that products be accurately labeled as to what their contents are and to actually contain those ingredients, which is a necessary regulation in order for consumers to make informed decisions. However, this simple mandate has grown into a bureaucratic monster which has decreed itself the sole judge, jury, and prosecutor (with its own



ERIC JON PHELPS

2-hr VIDEO tape



\$20.00 (+S/H) Code: VAV (0.75 lb.)

Eric Jon Phelps, the author of the blockbuster book *VATICAN ASSASSINS*, gave a 2-hour lecture at the Conspiracy Con 2002 held on May 25-26, 2002.

Eric's richly historical and profoundly informative lecture concerned the history of the Jesuit Order and their ultimate control of the Vatican, spanning

centuries of collusion. Eric's lecture includes slide presentations of graphics and photographs from his book. If you would like to see and hear, first-hand, the man who puts significant historical and conspiratorial pieces of the puzzle together, then this video tape is the one for you!

ALSO AVAILABLE: ON AUDIO CASSETTE

The 2-hr *AUDIO* tape version of ERIC JON PHELPS' popular Conspiracy Con 2002 Lecture.

SEE NEXT-TO-LAST PAGE FOR ORDERING OR CALL TOLL-FREE: 1-877-280-2866

\$10.00 (+S/H)

Code: VAA (0.5 lb.)

hit squads) on matters of medical efficacy.

Since Reich's time, and through the 1960s, 1970s, and 1980s, the FDA has consumed millions of taxpayer dollars to wage its war against natural approaches to healthcare. The result is that our healthcare system is one big gigantic expensive mess, rife with official fraud, and a holocaust of victims, due to the toxic and deadly side-effects from ineffective “approved” drugs and horrific surgical mutilations.

Nature, science, and compassion have been thrown out of the house of modern medicine, and the doors and windows have been barred shut, with armed guards posted outside.

The Congressional Battle

In spite of the damage done to many individuals, clinics, and small businesses, the natural health movement continues to fight back, through legal means and by pressuring their elected representatives to restrain the FDA. But the FDA has its own supporters in Congress, and wants even more power and authority so that it can go out and even more thoroughly “search and destroy” the natural health movement.

New legislation has been offered into the U.S. Congress which would grant the FDA the more complete and sweeping police powers it wants. In 1993, several new Congressional bills were proposed: the *Regulatory Enforcement Amendments for the existing Nutritional Labeling And Education Act* (H1662, H2597, H3642, S1982, S2135). Their sponsors are long-time FDA supporters and recipients of pharmaceutical PAC “donations”—Rep. Henry Waxman (D-CA), Rep. John Dingell (D-MI), Sen. Edward M. Kennedy (D-MA), and Sen. Howard Metzenbaum

(D-OH).

The proposed legislation would grant to the FDA:

- Power to set arbitrarily low potency levels for vitamins and foodstuffs, and to forbid the sale of any vitamin or foodstuff which contained levels higher than the FDA mandates.

- Power to forcibly censor advertising of health claims in magazines and books.

- Power to embargo and destroy any imported product without proving its threat to the public health.

- Power to issue its own subpoenas and to undertake WARRANTLESS searches, seizures, and electronic surveillance, based upon MERE SUSPICION, without the need for court approval.

- Power to set its own punitive fines against anyone who fails to obey their demands—up to \$250,000 for individuals, and \$2 million for businesses.

- Power to dictate to the Federal Trade Commission new regulations for censoring health claims in television and radio programs and advertisements.

- Power to pay informants a reward, up to \$250,000, for reporting on suspected violators of FDA regulations.

Other related legislation was also proposed (SS732, S733, H940, Sen. Edward Kennedy sponsoring on behalf of the Clinton Administration), which would establish a “national registry and tracking system” for the vaccination of all infants and children—a prelude to the notorious “Smart Card” or “Health Identity Card”—with total control over healthcare decisions by a centralized medical Big Brother. These bills, which are offered up in one version or another, year after year, mandate “social workers” to essentially become the new “healthcare police”,

calling upon every home in America, door to door, to “investigate” whether or not every child in residence would have all “mandatory vaccines”. If not, the child might be blocked from enrollment in school, or the parents charged with “child abuse”, and the child forcibly taken away by the state for adoption.

Already, legal attacks for “child neglect and abuse” have been mounted by social workers and medical authorities against parents opting for home-birth, and against parents refusing to inoculate their children with potentially dangerous experimental vaccines. [24]

Even breast-feeding mothers have had infants ripped from their arms, being charged with “child sexual abuse” by power-drunk “social workers” who did not approve of breast-feeding beyond two years. [25]

Coupled with the new, national health insurance initiatives, we rapidly approach the creation of a politically-directed, centralized network of “health spies” and “health police”, whose ultimate goal would be to root out any and all forms of natural healthcare, or anyone who would exhibit signs of independent-mindedness or “disobedience to authority” regarding basic matters of child-rearing, sexuality, education, or health.

This is reminiscent of the KGB neighborhood-spy systems of the communist nations, and the religious police of the fundamentalist Muslim nations. It is a clear and present danger to our democracy, given the fact that Americans today are prone to grant to white-coated “doctors” the same uncritical, unquestioning obedience as once was given to black-robed priests during the witch-burning period of history, or to communist-party functionaries during the Stalinist purges.

Science, particularly medical science, is today the New Religion of Homo Normalis, and the witch hunt against heretic disobedient unbelievers is gathering steam.

Opposing the above FDA/AMA/pharmaceutical Gestapo legislation was the *Health Freedom Act* (S784 and H1709) sponsored by Sen. Orrin Hatch (R-UT) and Rep. Bill Richardson (D-NM). This bill, which was passed in modified form, restricted the FDA on some of the above matters, preserving the rights of Americans to make their own essential health decisions—regarding vitamins, herbs, and food supplements at least.

There additionally are a few states, such as Alaska and Washington, which have passed specific legislation to protect natural healthcare methods, though it is

not clear that these laws do anything to restrain the FDA, which is governed by federal legislation. Rep. Henry Hyde (R-IL) has also sponsored the *Civil Asset Forfeiture Reform Act Of 1993* to restrain the “long arm of the law”, and place the burden of proof on the government in asset seizure cases, where it belongs.

These latter laws to restrain government power are a start in the right direction, but in fact do not go far enough to curb the persisting abuses.

Wilhelm Reich’s suggestion that judges, prosecutors, and government officials who plot to throw innocent people into prison should themselves be imprisoned, is the kind of strong medicine necessary to prevent our social situation from spiraling into even more despotic conditions.

Clearly, a Congressional Investigation with public hearings and testimony should be initiated in Washington DC to allow hundreds of ordinary citizens the right to come forward and tell their stories about U.S. government hooliganism, in full light of day, and where the “mainstream” news media could not so easily ignore it.

A Special Prosecutor should also be appointed by the President, to investigate the blatant Police State activities of the FDA and other governmental agencies.

FDA Commissioner Kessler should immediately be fired and investigated for his role in these abuses.

All FDA leaders, field agents, and lawyers, AMA officials, and prosecutors and judges who plotted, approved, or directed the invasions of clinics, laboratories, and homes of medical pioneers, carrying out the massive seizures of property where nobody was ever charged with a crime—those individuals should receive stiff fines and jail terms, with compensation paid to those whose lives and work was destroyed by power-drunk bureaucrats.

Even those now-elderly FDA officials, prosecutors, and judges who presided over the burning of Reich’s books should be held fully accountable for their past abuses of power.

These and other concrete steps must be undertaken if we are serious about our *Constitution* and *Bill Of Rights*, and if the words “land of the free” are to have meaning beyond that of a mere slogan, recited mindlessly at political rallies.

Clearly, unless our social reformers and healthcare pioneers are allowed to move from the present suppressed “underground” situation, and practice their arts openly in the social marketplace, free from constant FDA-police harassment, there will be no real health reforms or

pioneering health breakthroughs to reach the general public. The battle lines are drawn, but the outcome is not clear or certain at all. Hanging in the balance is nothing less than the future of our remaining democratic and social freedoms.

Postscript, 1995-2001

Since the time when this article was written, the following events have taken place:

- Congressman Henry Hyde has introduced new legislation to dramatically scale-back seizure laws, putting the burden of proof back on the government, where it belongs. To date, however, his reform measure is not part of the new “Republican Agenda”, and no meaningful reform has in fact yet taken place.

- Mrs. Scott, widow of the murdered Donald Scott mentioned above, sued the government for shooting her husband in his home without cause. She lost her case, which is on appeal.

- Congressional hearings on the Waco, Texas massacre of the Branch Dravidians has revealed that the FBI and BATF lied and fabricated documents later presented to the U.S. military and Justice Department, falsely claiming a “methamphetamine laboratory” was in the Dravidian’s compound. This lie allowed the military to provide helicopters and tanks to the FBI, for use in the subsequent “final assault” on the compound, which resulted in the deaths of nearly all inhabitants. (Federal law prohibits the use of military weaponry and resources in civilian law enforcement, except in drug-related cases.)

The hearings also revealed a sharp split between the FBI/BATF “troops” on the ground surrounding the compound, and the FBI negotiation team, who were in telephone communications with Koresh and the Dravidians inside the compound. The “troops” were literally “chomping at the bit”, wishing to invade the compound with poison gas, concussion grenades, tanks, machine-guns, etc., in spite of the fact there were women and children inside. A deal which had been arranged by FBI negotiators for complete surrender of the inhabitants was sabotaged by the “troop” leaders who pushed for the gas attack (flame attack?), and whose contempt for the negotiation team was well-documented.

To my knowledge, the issue of the flame-throwing tank, documented in videotapes [8], was never openly

discussed at those hearings. FBI top brass were reprimanded, but nobody has been charged with any crimes, and nobody has spent a day in jail for the nearly 100 civilian deaths, or the subsequent cover-up.

• New “anti-crime” and “anti-terrorism” legislation, some of which was rammed through Congress after the Oklahoma City bombing, provides even more sweeping powers to the FBI, and for both CIA and military resources to be used against U.S. citizens for anti-drug or anti-terrorism activities.

The problem here is the very wide and broad definitions of what constitute such activities. Even before the new laws were passed, anti-drug legislation had been abused to attack physicians engaged in natural healing methods.

(Note in 2001: More leeway is given to the FBI and CIA in new anti-terror laws following the disastrous WTC and Pentagon airline terror-attacks. While it is the opinion of this writer that these laws are justified and necessary in this time of national emergency [*except that such “national emergency” was obviously fabricated by the same ones pushing the subsequent legislation!*], it is also a legitimate fear that they will be misapplied against unorthodox physicians and healers by the FDA [*among many other targets*].)

• Dr. Jonathan Wright, with help from citizen’s organizations such as National Health Federation, Cancer Control Society, and Citizen’s For Health, organized a public relations assault upon the FDA and fought back with lawsuits. He won a victory of sorts when the FDA recently announced they were not going to file charges against Wright, even though for 3 years they have illegally held onto his property, patient records, computers, files, etc. The Congressional legislation which would have given the FDA increased power and authority was passed, though in watered-down form. New legislation by both pro-FDA and anti-FDA forces have been organized. The battle is not yet won.

• Newt Gingrich and other Republicans announced in 1995 that they would “take on the FDA” and “restrain its powers”. This led, in my opinion, to a highly premature celebration on the part of many health-reform activists, that the new “Republican Revolution” would bring about more freedoms in healthcare. Unfortunately, in various televised and published interviews, it is unmistakably clear that **the new Republican Congress only wishes to prevent the FDA from restraining the drug companies and**

The SPECTRUM

ARCHIVED ON CD-ROM!



\$45 (+S/H) Each
 Order Code: CDR1, CDR2,
 or CDR 3 Wt. (0.5 lb.)

Get each full year of *The SPECTRUM* archived on CD-ROM. One year per volume. Volume 1 thru 3 are now available. CD-ROMs are PC & MAC compatible.

PLUS YOU ALSO GET ON THE CD:

Several Audio Chapters from *WISDOM OF THE RAYS: The Masters Teach*, Vol. I book. These will play on your audio CD player. • Several writings by the Ascended Masters • Selected writings and interviews (non-audio) • French translations of several writings by the Ascended Masters (non-audio) • Adobe Acrobat Reader for Windows and Macintosh.

NOTE: Volume 3 does not contain any audio tracks; it is strictly a data CD-ROM. You must have a computer in order to use this disk.

SEE NEXT-TO-LAST PAGE FOR ORDERING OR CALL TOLL-FREE: 1-877-280-2866

medical device industry.

I personally overheard, on one of the televised news programs, a debate between leading Republican and Democratic lawmakers, wherein **they both emphatically stated that they were opposed to “medical quackery” (meaning: natural healing methods) and both supported the FDA in its efforts to “clamp down” on healing methods not approved by “general medical practice”**. In short, there is no evidence that natural healing methods will get more support from the Republicans than from the Democrats.

• In the face of evidence of demonstrated health risks, and strong protests by citizen’s health groups, the FDA has approved the public marketing of dangerous new drugs and vaccines with proven toxic side-effects, irradiated foods (for food preservation), genetically-engineered bovine hormones (for stimulation of milk production in cows), and artificial fat. In coordination with the push to provide BGH to all American milk cows, “protein bypass” feeding methods have been initiated, wherein the carcasses of sheep and cattle (even those which have died of unknown causes) are ground-up and mixed with cattle feed, and then fed back to the dairy cattle for “protein enrichment”. Such foul and unclean feeding methods were part of the reason why Mad Cow Disease spread in England. A similar syndrome exists in the U.S.A. under the name “Downer Cow Syndrome”. Because of such health risks from American beef, the European Economic Community has a ban on the importation of American beef products. **The FDA says it is OK for**

Americans to eat what Europeans feel is unclean and unsafe.

• In late 1996, the FDA announced plans to try and “regulate” (read: suppress) the free flow of information on “unapproved” healing methods on the Internet. As always, they want to control what is said, and by whom, on health matters.

• As of 1996, Dr. David Kessler was still in charge of the FDA. But not much long after. Kessler left the FDA, and at least some of the rather draconian police-state aspects of FDA attacks against holistic medicine have declined in frequency ever since. This does not mean the FDA has “reformed” however, as seen in their enthusiastic embracing of genetically-modified foods, and their push to introduce food-irradiation, and to undermine all efforts to have genetically-modified foods fully labeled.

References

1. Barry Lynes, *The Cancer Cure That Worked: Fifty Years Of Suppression*, Marcus Books, Ontario, 1987.
2. Ken Ausubel, *Hoxsey: How Healing Becomes A Crime*, Mystic Fire Video, Malibu, California, 1987.
3. Max Gerson, *A Cancer Therapy: Results Of 50 Cases*, Gerson Institute, Bonita, California 1990.
4. Jerome Greenfield, *Wilhelm Reich Versus The USA*, W.W. Norton, NY 1979; Lois Wyvell, “The Jailing Of A Great Scientist In The USA”, *Pulse of the Planet* #4, 1993; James DeMeo, “Author’s Preface”, *The Orgone Accumulator Handbook*, Natural Energy Works, El Cerrito, CA 1989.

5. J. C. Bailar & E.M. Smith: "Progress Against Cancer?", *New England Journal Of Medicine*, 314:1226-1232, 8 May 1986.

6. *Acres USA*, PO Box 9547, Kansas City, MO 64133.

7. *San Francisco Chronicle*, 25 June 93; *Contra Costa Times*, 5 June 93; *Bay Guardian*, 2 June 93; *Pacific Sun*, 12 March 93.

8. A videotape "Waco, The Big Lie" (*American Justice Federation*, 3850 S. Emerson Ave., #E, Indianapolis, IN 46203) shows flame-throwing equipment on the front of the tanks which assaulted the Waco compound, casting serious doubt upon the "official" version of events.

9. Eisenberg, et al; *New England Journal Of Medicine*, 328:246-52, 1993.

10. *Health Federation News*, March 1993; *SF Chronicle* 16 Feb. 93, 18 May 93, 13 Sept. 93.

11. *Health Federation News*, March 1993; *SF Chronicle* 16 Feb. 93, 18 May 93, 13 Sept. 93.

12. GAO/PEMD 90-15 *FDA Drug Review: Post Approval Risks 1976-85*, p.3, 28 April 1990.

13. *FDA Versus The People Of The United States*, Jonathan Wright Legal Defense Fund, Citizens For Health, PO Box 368, Tacoma, WA 98401; phone: 206-922-2457, Fax: 206-922-7583.

14. *FDA Versus The People...* *ibid.*

15. *Body & Soul*, 8(4):6, June 1992; *FDA Versus The People...* *ibid.*

16. *FDA Versus The People...* *ibid.*

17. *FDA Versus The People...* *ibid.*

18. *FDA Versus The People...* *ibid.*

19. *FDA Versus The People...* *ibid.*

20. *Seattle Post-Intelligencer*, 7 May 92, 11 May 92; *FDA Versus The People...* *ibid.*

21. *FDA Versus The People...* *ibid.*

22. *FDA Versus The People...* *ibid.*

23. *Sarasota Eco Report*, July 1993; *Am. Preventative Medical Assn.*, PO Box 2111, Tacoma, WA 98401; phone: 206-926-0551, Fax: 206-922-7583.

24. Regarding the vaccine issue, see: Neil Z. Miller, *Vaccines: Are They Really Safe And Effective?* New Atlantean Press, NM, 1993; "Vaccinations: The Rest Of The Story" *Mothering Magazine*, PO Box 1690, Santa Fe, NM 87504.

25. The average age of weaning, worldwide, is around 3.5 years. See the case of Denise Perrigo in New York, discussed in *Birth Gazette*, Spring 92, p.11; also discussed in *Sex-Economic Notes, Pulse of the Planet* #4, 1993.

[end quoting]

Even though the above article is almost ten years old, it speaks with great clarity about the trend, already then in

full swing, to deny Americans the freedom to choose their own pathway to health. And since the contrived events of 9/11, that trend has only been expanded through even more legislation—like the *Patriot Act* and the *Homeland Security Act*—which is designed to further limit our fundamental freedoms in all aspects of living, including health.

Much More Has Been Written

There has been so much written on this subject that there is simply not room to include more of it here. Just a few of those additional, substantial, and more recent articles that have been written about the FDA's abuse of authority include (available online):

- *LEF's Magazine*, August 1998, titled "First Amendment & Codex Alert" by William Faloon.

- "FDA Abuses Alternative-Medicine Industry But Is Lax On Drugmakers" by Milton R. Copulos, appearing in *Insight On The News*, and posted on the *Life Extension* website.

- "A New Day At FDA? After Years Of Battling In The Court, The FDA May Finally Be Forced To Comply With The Law—AGAIN" appearing in *Life Extension Magazine*, April 2003.

FDA—A Rogue Agency

With such a long pattern of abuse of power, some important questions come to mind:

What can be done to curtail these abuses by this aggressive super-puppet agency with an annual taxpayer-supported budget (that we know about) of \$27,355,000?

Has Congress effectively abrogated its authority over the FDA, thus coming in violation of Article 1, Section 1 of the *U.S. Constitution*, which states that: "All legislative powers herein granted shall be vested in a Congress...?"

And if Congress is in violation of the *U.S. Constitution*—**still the highest legal authority in the land regardless of efforts to make it subservient**—what is to be done about it and by whom?

Could Congress, despite its current impotent role, be pressured enough by we-the-people to appoint a Special Prosecutor to investigate a long pattern of criminal activity, theft, and intimidation by the FDA—the very agency it is turning its own authority over to?

And at what point do

the individual States step forward, under pressure from the citizenry, to address legal violations of basic rights by these federal thugs manipulated by Big Business and those higher up the world-control ladder?

The fact remains that government, unchecked, is hardly likely to police itself! It's the responsibility of we-the-people to correct this out-of-control situation that's gotten to this point precisely because WE'VE not been minding the store.

Class Action? That's one possibility. Certainly with the number of "alternative" healthcare and wellness organizations that exist throughout the United States, NETWORKING BECOMES KEY to finding united solutions that have been begging attention for so long. It takes aggressive participation. Perhaps even aggressive lobbying. (Note: I didn't say hostile or violent; I said aggressive.)

Consider the tragic toll in terms of compromised health, lost human lives, and unnecessary astronomical costs due to the suppression of Rife and other powerful technologies by the FDA over the years, especially since the early 1930s! AND THEN ASK YOURSELF HOW WE CAN POSSIBLY LOOK THE OTHER WAY AND ALLOW SUCH A MOCKERY OF COMMON SENSE TO CONTINUE!

Whatever the final outcome may be, the fact remains that more and more people ARE stepping-up and taking responsibility for their own health, and no amount of "bought" legislation will reverse that wise and determined trend. It's time for the politicians to pay attention to the will of their constituents, not to Big Business and other related special interests that have for so long manipulated public policy.

When will we finally hold Congress accountable for playing a significant role in such extensive criminal behavior against we-the-people?

Nobody said reclaiming our health freedom was going to be easy. But what's the alternative?

And think about this: How important is your health to YOU?! 

"The whole imposing edifice of modern medicine is like the celebrated tower of Pisa — slightly off balance."

— Charles, Prince of Wales

Who Was Dr. Wilhelm Reich?

And Why Has History Tried So Hard To Erase Him?

Editor's note: The following superb article, from the March 13, 2003 issue of The Idaho Observer, is offered as an important extension in conjunction with this month's front-page feature story. Dr. Wilhelm Reich is mentioned in that story (along with Dr. Royal Rife) as another significant trailblazer whose advanced research was viciously attacked and suppressed by those wishing to preserve the status quo of people control on planet Earth.

Reich's research opened up vistas of possibilities with such far-ranging implications—well beyond “just” the simple curing of illnesses—that his work held the keys to nullifying the core forces of coercion utilized by the world controlling elite to keep the rest of us in line. You can imagine how many big-ego toes he stepped on—whether he realized it or not!

The Idaho Observer introduction to this article states Reich's situation well:

“Before dismissing what you are about to read, consider that the FDA did everything in its power to eliminate the knowledge of orgone energy from the world because, it claimed, ‘it doesn't exist.’

“If orgone energy does not exist, it is, therefore, not a threat—is it?”

“Rather than ignore this thing that does not exist, the FDA effectively sentenced Dr. Wilhelm Reich to death and, for at least a decade, actively pursued a campaign to destroy all the books, notes, and research papers it could find containing the word ‘orgone’. Judging by the government's actions, orgone energy does, indeed, exist.”

Their extreme actions against him only served to reveal, beyond any doubt, just how important Reich's research actually was.

3/13/03 JERRY MORTON

Dr. Wilhelm Reich (1897-1957) is still noted historically for his work in psychiatry and psychoanalysis. However, Dr. Reich's work in biophysics has been stricken from the historical record.

In the mid 1930s Dr. Reich began noticing an energetic connection that is shared by all living beings and had the clarity of mind to not dismiss the observation as unimportant. Dr. Reich called this energy “orgone” and worked for decades demonstrating its laws and studying its various manifestations.

His work encompassed 40 years within six countries, but in the end he suffered the indignity of seeing his life's work

by the American government and the American medical system.

Wilhelm Reich was born in Austria in 1897 as the son of a rather wealthy farmer and, as was common at that time, he was home schooled, first by his mother and later by a number of tutors. He excelled in his studies because of his intelligence and also, in part, out of fear of his father's horrible temper that would erupt over something as trivial as an incorrect answer in his studies.

Reich's family was tragically dysfunctional and, at age 13, his mother poisoned herself to flee the abuse of Reich's violently-tempered father. Four years later, Reich's father died of pneumonia—a financially destitute and lonely man. Reich, at 17, ran the farm himself for a short time after his father's death, but the property was destroyed by World War I in 1915.

After serving in the Austrian army on the Italian front, Reich began attending classes at the University of Vienna and graduated in 1922 as a doctor of medicine.

While studying for his doctorate, Reich became a protégé of Dr. Sigmund Freud, and soon after graduating became the clinical assistant at Freud's Psychoanalytical Clinic where he, himself, became a pioneer in psychoanalysis.

In his book *Character Analysis* (1933), Dr. Reich detailed a biological basis for neurosis and provided a step

toward the discovery of the cosmic orgone energy. During the years 1936-1939, Dr. Reich conducted experiments concerning the idea of airborne infection.

He showed that microorganisms form themselves from inorganic material and disintegrating organic substances. He proved where airborne germs came from and demonstrated the absurdity of the commonly held “air germ” theory. It was during these experiments in 1939 that Dr. Reich accidentally discovered radiation particles which he later named orgone.

An assistant had mistakenly taken the wrong container from the sterilizer and

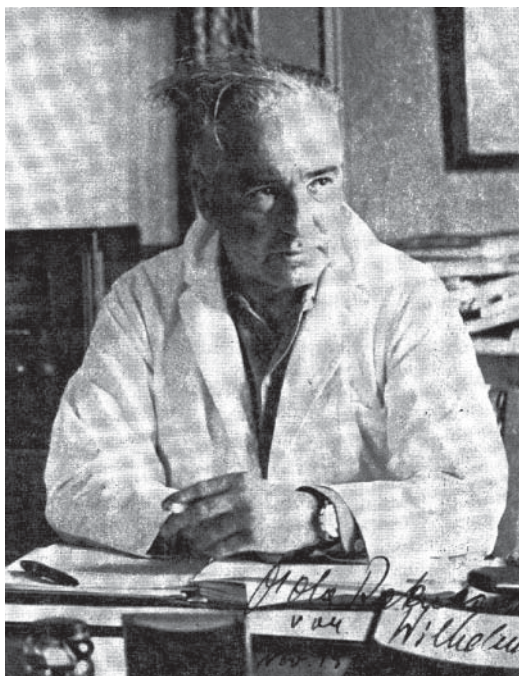

Wilhelm Reich

banned in America and tons of his books and journals burned by the U.S. Food and Drug Administration per bureaucratic decree.

It was a brazen act of censorship that is overlooked today within the texts of history.

Prior to his organomic research, Dr. Reich had earned an international reputation as a scientist of integrity. Once, after he had demonstrated orgone energy to Albert Einstein, the famous physicist exclaimed that “this would be a bombshell to physics”.

Dr. Reich spent his last days in prison falsely labeled a quack and a racketeer

heated the substance within it to incandescence. The substance was common ocean sand and, when cultured and inoculated on an egg and agar medium, yielded a yellow growth. When viewed under high magnification this growth was seen as vesicles (he called them SAPA bions) that glimmered an intense blue color that, in time, would grow and then move about.

As he continued to experiment with these "bions" he noticed that, when he placed live cancer cells next to them, the cells would die. It was during days of observing these phenomena that Dr. Reich came down with an extreme case of conjunctivitis, and his eyes became very sensitive to light. He noticed that it affected his eyes the most when he was looking at these vesicles through his microscope.

During the course of this work, in the winter of 1939, Dr. Reich also noticed that he had developed a suntan under his clothing. He reasoned he was being exposed to some type of radiation, and it greatly worried him. He used a radium electroscope to test the culture tubes, and it gave no reaction. It took a few weeks for him to realize that this newly noticed radiation (that he had named "orgone") was present everywhere.

Taking his SAPA bions into the darkness of his basement and waiting for two hours, he noticed that his hair and clothing emitted a blue glimmer, and the room was filled with a hazy, slow-moving, gray-blue vapor.

Over time, Dr. Reich demonstrated that the orgone radiation was the same energy that the Sun gave off and that the incandescing and swelling of the sand had released this energy once again from its material state. He was forced to this conclusion by the facts before him, but he admitted having to overcome great emotional reluctance in doing so.

Further experiments showed that this ever-present orgone would be repelled by metal objects and absorbed by organic material. By making a box with alternate layers of organic material (wool) and metal, Reich found that he could accumulate a more concentrated field of orgone. He called these boxes "orgone accumulators" and they played a major role in his experimentation with orgone.

Nearly 15 years later, the American government made an attempt to wipe the very word "orgone" from the English vocabulary, by banning the

accumulator and destroying Dr. Reich's books and journals.

Dr. Reich was able to watch orgone in the various forms it would take on within an accumulator. The forms were: a bluish-gray fog-like formation, deeply blue-violet luminous dots, or whitish rapid rays.

He was also able to demonstrate and measure orgone with a thermometer and an electroscope, as well as with a Geiger counter.

[Editor's note: These very sensitive but very different devices—and other instruments, if they had been available at the time—all respond to this energy



Dr. Reich under arrest.

because it interacts with the very SUB-STRUCTURE of the physical matter out of which all the different instruments are necessarily constructed.

For example, it's not that the orgone is radioactive; but in the case of the Geiger counter's REACTION to an orgone concentration, it may seem that way. In actuality, the concentration of orgone likely changes the properties of the gas in the Geiger counter's high-voltage tube, causing the gas to behave differently (like ice behaves differently than water or steam), and thus the Geiger counter acts AS IF something radioactive were present.

This is a common problem (and often overlooked consideration) when analyzing experiments that involve psychic energies like psychokinesis. Did the psychic's mind influence, say, the actual thermometer that's buried fifty feet

below the floor (as is often claimed), OR influence the circuitry sitting right in front of the experimenter that converts the thermometer's output signal to read on a chart recorder?]

What astounded Dr. Reich was the fact that, for over two thousand years, the presence of this orgone energy was overlooked or argued away whenever a scholar attempted to describe what he saw.

What Dr. Reich discovered is nothing short of the energy responsible for the biological pulsation of life on Earth (and possibly the universe). Rather than embracing Dr. Reich's discoveries, the collective (politically motivated) scientific community responded with levels of anger and derision that bordered on hatred; rather than conducting investigations of their own and furthering the knowledge of orgone energy for the betterment of mankind, the (politically motivated) scientific community led the charge to destroy any documents that even mention the word "orgone". And then the (politically motivated) scientific community destroyed Dr. Reich.

[Editor's note: In our modern world, the first line of defense is to block publication of the "politically incorrect" discovery in the scientific literature, and then terminate the researcher's financial lifeline while attempting to malign professional reputation—as I (E.Y.) wrote about in the page-3 editorial. That's how the religion of science is kept "pure" these days!]

Though a meticulous researcher and prolific scientist, Dr. Reich saw himself as only a pioneer in the field of organomy (the science of orgone) and likened himself to Christopher Columbus. In his book *Ether, God, And The Devil* (1950 and 1951), he said that, as Columbus did not discover New York City or the resources on the West Coast of America, but rather a stretch of seashore that was up to that time unknown to Europeans, so he only discovered the orgone energy. This phenomenon, being the common etheric energetic thread coursing through all life forms, represents a universe of discovery of which Dr. Reich located only one small shoreline.

The object of the (politically motivated) scientific community's opposition of Dr. Reich's work was his "orgone accumulator". The orgone accumulator, a "box" large enough for a person to sit in and constructed of alternating layers of organic and inorganic substances, was used to

successfully treat his patients for various maladies.

In his book *Cancer Biopathy* (1948), Dr. Reich recreates his carefully documented work regarding the treatment of several cancer patients deemed hopeless and terminal by orthodox medicine. Several of his cancer patients were “cured” but, being the careful man of science he was, Dr. Reich was careful not to declare orgone treatment as a cure for cancer.

After a lengthy harassment campaign by the FDA over the medical use of orgone, that began in the mid 1940s, Dr. Reich died in prison in 1957.

[*Editor's note: Appreciate that the medical mafia had just gotten Rife pretty much under control by the mid-1940s, and then along comes Reich's threat to the controlling empire. Their own brutally aggressive posture unmistakably gave away how important Reich's work actually was recognized to be by those who truly understood it!*]

All of his books and papers were, by federal decree, burned, up through 1962, and may have continued on a lesser scale until 1970. The government of the United States had declared that orgone did not exist and orgone was the only word that was necessary to appear in print to qualify the material as worthy of destruction.

During the course of his varied orgone experiments, Dr. Reich touched upon many aspects of science. Among these, the disciplines of medicine, physics, cosmology, and meteorology. He discovered atmospheric orgone and noticed that, in the presence of pollutants of various kinds, including electromagnetic emissions, the orgone would become stagnant and cause illness and environmental damage.

Dr. Reich called this “stagnant” orgone, “dead” orgone or “DOR”. The effects of DOR would often be that of drought and the formation of deserts.

To counter the effects of DOR, Dr. Reich added long pipes to an orgone accumulator box and pointed it skyward to help balance the atmospheric orgone and bring rain. He called this device a “cloud buster”.

In one experiment starting in October, 1954, Dr. Reich was successful in bringing rain to the desert around Tucson, Arizona. Even before the rain fell, the newly-balanced orgone had caused the grass to grow a foot tall in the desert. This green spectacle stretched some 40 to 80 miles to the east and north of that city. It took tremendous skill to use the cloud buster because it drew the dead orgone into the device and could

pose serious health problems to both the operator and the atmosphere itself.

The ability to safely use the cloud buster died with Dr. Reich and remained buried for half a century.

Science, good or bad, historically moves forward of its own inertia; a scientist dies, another scientist picks up his notes and continues where he left off. Not so with orgonomy. It wasn't until almost 50 years after the (politically motivated) scientific community sentenced Dr. Reich to death and erased



Patient using “orgone accumulator” box.

the memory of his work from history that a new and improved cloud buster would be developed.

Self-taught bioelectric innovator Don Croft has recently developed a modern cloud buster he claims is safe for both the operator and the environment.

Dr. Reich touched upon many aspects of the cosmic orgone energy and knew that it would take many people to develop the many potentials of its nature. In 1948 a close friend of Dr. Reich, by the name of A.S. Neill, stopped by Reich's laboratory, called Orgonon, in the state of Maine. He saw a small motor turning over that was attached to an orgone accumulator. He said that Reich cried out with great joy: “The power of the future!”

When later asked if he had developed that power source any further, Reich is reported to have said that his job was one

of discovery and he was going to leave it to others to carry out the results.

* * *

Note from Don Harkins, Editor of *The Idaho Observer*:

The Idaho Observer understands the controversial nature of orgone energy. Though one cannot see or smell it, sensitive equipment can measure it. Therefore, it exists—regardless that the FDA determined [*actually just pronounced, like a decree*] it did not exist in 1954.

Our contemporary controversy, therefore, has nothing to do with whether or not orgone energy exists, because the federal government's non-scientific wishing-it-away doesn't make it so. The controversy is the modern adaptations of orgonomy and claims by a growing circle of people who believe that Reich's work provided a foundation for positive changes in our embattled world.

One has to wonder if those who worship the “DOR” and revel in its ability to cause misery recognized Reich's discoveries as a direct threat to their globalist intentions. Is that recognition the power behind the campaign to ruin the man and erase the memory of his orgonomic research from history?

The answer becomes obvious when you place into perspective what the government did to Reich. It killed him at the age of 60 for continuing to research, without FDA approval, something it claims does not exist. When asked to prove orgone energy does not exist, it refused to provide the science that supports its claims or the identity of those who conducted the experiments and reached that conclusion.

Those who have ever taken a high school-level biology class understand the scientific method and can determine that Dr. Reich was sent to his death by a government that ignored science to make a political point for all those who may wish to explore orgone energy: Do not.

Most *Idaho Observer* readers understand energy—that good energy which produces good things (like sunshine, positive thoughts, healthy food, and healthy bodies) occupies higher vibrational frequency ranges, and bad energy that produces bad things (like rot, disease, unhealthy food, and negative thoughts) occupy lower vibrational frequency ranges.

It follows, therefore, that a world saturated in low-frequency vibrations will produce a world filled with anger,

hostility, disease, and death.

What kind of world do we live in now?
Ah, success.

Because the U.S. government has managed to keep low, through a variety of socio/political maneuvers, the vibrational frequencies within which Americans operate, our people are sick, angry, frightened, and living in chaos—the environment most conducive to totalitarian control.

Dr. Reich's work evoked the wrath of the baby totalitarian state. It killed him to send a message to scientists that orgone energy is off limits for further study. In the absence of scientists developing beneficial applications for orgone energy, the totalitarian state has come of age.

Now it appears we have nothing left to lose. The pretense of freedom is gone. All that remains is the illusion of freedom being kept alive in the minds of dwindling numbers of Americans.

As the totalitarian police-state emerges, its emissions of dead, stagnant energy from exponentially-increasing sources (both organic and inorganic) is also increasing. Rising to the challenge are groups of people who have picked up Dr. Reich's work and are running with it.

Next month we will continue this story [*in the Idaho Observer newspaper*] with the adventures of those who claim to be using orgone energy to replace bad energy with good.

A small candle, when lit, can, all by itself, overcome darkness, where the same amount of darkness cannot similarly affect light. The same is true when it comes to good and bad energy. That's why bad energy must have outside help from government and its duplicitous minions to prevail.

Those who have chosen to expand upon Reich's work believe they can

prove to a candid, if not doubting world, that the following ills can be corrected by the proper application of techniques that harness orgone energy. They believe in their ability to prove how properly directed orgone energy will neutralize bad-energy emissions from cell towers, chemtrails, and angry people. They also believe they can reproduce Dr. Reich's experiments and bring rain to drought-ridden areas.

Can they direct orgone energy to accomplish these things? My own personal skepticism has been extreme for many months. However, a few things have happened to cause my skepticism to waver and my hope begin to grow.

Besides, we haven't much else to lose. Wouldn't it be marvelous if something as simple as overcoming bad energy with good is the antidote for all the evil which has so saturated our modern world? Isn't it also just like God to set things up to be so simple even His human children can do it?

* * *

Whatever Happened To William Washington?

by Don Harkins

As Dr. Reich indicated, he only discovered the shoreline of what could lead to a universe of potential applications for orgone energy. Though we may never know which potential application caused the federal government to sentence Dr. Reich to death and zealously seek out and destroy all references to his work, a clue may be found in the mysterious Fall of 1948 disappearance of William Washington.

Reich biographer and Harvard graduate Myron Sharaf (*Fury On Earth: A Biography Of Wilhelm Reich*, 1983), claims to have met "Bill" at the University of Chicago when they were both freshmen in 1944.

Sharaf explains that Bill began working with Dr. Reich in the summer of 1947 to help him with the mathematics of developing an orgone energy motor. "When he left Orgonon in Fall, 1948, he took the motor set-up with him in order to work on further refinements. He was supposed to return to Orgonon in early Summer,

1949, but he did not appear, nor was there any word from him" wrote Sharaf.

Sharaf and Dr. Reich checked out some of the stories Bill had told them about his past and previous employment. "None of these stories proved true" Sharaf noted.

Dr. Reich was able to speak to Bill on the phone once in late Summer, 1949. Reich, a lifelong student of the human mind, deduced that Bill was hesitant in his speech because he was being monitored by some outside force, probably the federal government, a conclusion not shared by Sharaf. "Washington was never heard from again" wrote Sharaf.

Ola Raknes, Ph.D., had observed the orgone-force motor in action and saw that the theory was valid. Unfortunately, no further research into this area was conducted after Bill left Orgonon. "This would be an extremely important area of orgone energy research" Raknes observed in 1970.

* * *

The following is from the book *Wilhelm Reich And Orgonomy—The Great Psychologist And His Controversial Theory Of Life Energy*, by Ola Raknes, Ph.D, of Norway, 1970:

What Is Orgone Energy?

Dr. Wilhelm Reich was first a protégé and then a contemporary of Sigmund Freud. Most people associate Freud with his belief that the manifestations of being human are directly related to sexual repression or expression.

As Dr. Reich's work began pulling away from that of Freud, he became intrigued with identifying the specific form of energy that made sexual expression possible. He discovered that the formula of function that led to an orgasm was the common formula of function for all biological processes in all living matter: tension > charge > discharge > relaxation.

Dr. Reich isolated the particle responsible for this formula and named it "bion". He was also able to culture bions from inorganic matter and, quite accidentally, solved the riddle of biogenesis: He discovered the mechanism whereby lifeless substances transition to living matter.

He later named the energy that resulted from bionic activity "orgone". It's properties can be summarized as follows:

1. Organic substances attract and absorb orgone energy.
2. Metallic substances attract and repel

The Idaho Observer

Now that we know what is really going on, let's do something about it

The Idaho Observer is a monthly, 24-page newspaper dedicated to the truth. For a complimentary copy, please write:

PO Box 457, Spirit Lake, Idaho, 83869;
or call: (208) 255-2307.

\$1 for postage is appreciated but not necessary.



email: observer@dmi.net
web: www.proliberty.com/observer

or reflect orgone energy.

3. Stoppage of orgone energy by any metallic obstacle, as well as by a sensitive living organism, will result in a rise in temperature.

* * *

Final Comments By Don Harkins
(Editor, *The Idaho Observer*)

We should begin construction of the Museum of Federally-Buried Technologies so we can dream about what the world would be like if problem-solving intelligence was celebrated instead of persecuted.

Did the FDA ban evil's antidote in 1957?

Dr. Wilhelm Reich, MD, died at the age of 60 after serving eight months of a two year prison sentence. Since his death, tremendous energy has been expended to erase his memory from history.

One must ask: "Why?"

The following paragraph, taken from the book *Wilhelm Reich And Orgonomy*, by Ola Raknes, Ph.D, sets the stage for answering that question:

"The existence of such energy is still contested—or at least neglected—by practically all scientists who have not themselves made the observations and experiments, and had the experiences, that form the basis of the discovery. An American Federal Court has even, in March, 1954, in a Decree of Injunction, declared Orgone Energy to be nonexistent, without, however, giving the facts on which the Injunction is said to be based. In a correspondence with the present writer [Raknes] the Food and Drug Administration (FDA), on whose complaint the Injunction was decreed, said that experiments executed with the most modern equipment and methods by experienced scientists had proved the nonexistence of orgone energy. None of these experiments has ever been published, and in further correspondence, the FDA refused to divulge the names of those scientists or any of the experiments on which the complaint was said to be based. As Dr. Reich did not obey the injunction, he was arraigned for contempt of court and sentenced to two years in the penitentiary. He died in prison after not quite eight months."

Dr. Reich, a world-renowned psychologist and protégé/contemporary of Sigmund Freud, was sent to prison at age 60 to die because he insisted upon continuing his research into orgone energy—in defiance of a federal injunction that resulted from the FDA's apparently unscientific opinion that orgone energy did not exist. All Reich's books were banned, and those that were found were burned by the FDA. Any printed matter that contained the word "orgone" was subject to the ban and burning by the FDA per the injunction. The injunction was still holding in 1970.

The question now becomes: "What is orgone energy?"

If it did not exist, why did the federal government behave so militantly in its attempts to remove all mention of it from the world of print and the minds of people? Why did the federal government give a death sentence to a well-respected old man for insisting upon continuing his studies of something that doesn't even exist?

The federal government has used its authority to ban many viable and useful technologies. Should we accept the FDA's position that orgone energy doesn't even exist? Or, is it in our best interests to take another look at Dr. Reich's work and his controversial theory of life energy? More importantly, can orgone energy be used to help neutralize the negative energies that so permeate our modern world? 

COMMON SENSE II



Thomas Paine's pamphlet *Common Sense* was written and widely circulated in 1776. The simple logic and wisdom presented in *Common Sense* persuaded thousands of ordinary citizens to support a movement that sought to unite the colonies in an effort to win their independence from England. The birth of our nation and freedom from King George's tyranny is a direct result of this nation's people understanding the REAL issues and choosing freedom over tyranny.

We, the editors of *Common Sense II*, are anonymous—just as *Common Sense* was originally published anonymously. We recognize that this 92-page, 3" x 6" booklet has tall shoes to fill. Time is running out and we must once again persuade our countrymen to choose freedom over tyranny.

The sole purpose of *Common Sense II* is to awaken our sleeping countrymen. We have compiled the most illustrative and eloquent writings available, and have arranged them in the manner most likely to persuade a nation to stand up for freedom and independence—our God-given rights!

The Cover: The signal lantern for Paul Revere's infamous ride shined in Boston's Old North Church to warn vigilant colonists that the King's troops were heading toward Lexington and Concord, Massachusetts, early on the morning of April 19, 1775. The light is shining again today.

SEE NEXT-TO-LAST PAGE FOR ORDERING OR CALL TOLL-FREE: 1-877-280-2866

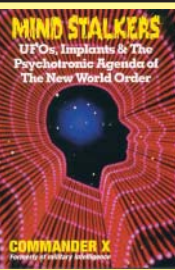

MIND STALKERS: UFOs, IMPLANTS, & THE PSYCHOTRONIC AGENDA OF THE NEW WORLD ORDER

ALIEN ABDUCTIONS, ELF WAVES, MENTAL MANIPULATION—ALL EQUALS BEHAVIOR MODIFICATION! There is a secret plot by the New World Order to control the Earth's population for a sinister agenda. Many UFO abductees maintain they have become part of a brainwashing program by "aliens"—but is a "secret society" really behind all that is happening?

SEE NEXT-TO-LAST PAGE FOR ORDERING OR CALL TOLL-FREE: 1-877-280-2866

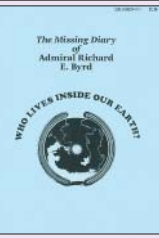

The Missing Diary Of Admiral Richard E. Byrd

"I must write this diary in secrecy and obscurity. It concerns my arctic flight of the nineteenth day of February in the year of nineteen hundred and forty-seven.

"There comes a time when the rationality of men must fade into insignificance, and one must accept the inevitability of the Truth! I am not at liberty to disclose the following documentation at this writing, perhaps it shall never see the light of public scrutiny, but I must do my Duty and record here for all to read one day in a world which hopefully the greed and exploitation of certain of mankind can no longer suppress that which is Truth."

—Admiral Richard E. Byrd (from the Introduction)

SEE next-to-last page or call toll-free: 1-877-280-2866

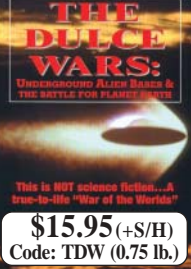

THE DULCE WARS: Underground Alien Bases & The Battle For Planet Earth

Is an alien "Fifth Column" already active on Earth preparing total conquest via implantations and mind control? In the corner of a small town in America's Southwest something very strange is going on. Did U.S. military forces perish recently in hand-to-hand combat with a group of hostile "Greys" who subsequently seized control of one of our top-secret underground bases? Includes latest on animal mutilations, energy grids, secret societies, lost civilizations, abductions, and missing time.

SEE NEXT-TO-LAST PAGE FOR ORDERING OR CALL TOLL-FREE: 1-877-280-2866

Cancer Research: *A Super* Fraud?

Editor's note: Given the theme launched by our front-page feature story this month and expanded through several other articles, the following is surely another very important contribution to the overall picture, one that should be publicized as widely as possible.

This is a well-researched 1997 article from "down under" (remember the story from there in last month's News Desk on the attack on health supplements?) copyrighted by the Campaign Against Fraudulent Medical Research, P.O. Box 234, Lawson NSW 2783, Australia; phone +61 (0)2-4758-6822; website: www.pnc.com.au/~cafmr.

What this contributes to the overall picture is a professionally strong, honest, and bluntly stated appraisal of the outright fraud being perpetrated by so many working in cancer research today.

Regular readers of The SPECTRUM will need to be kind in terms of overlooking that this analysis stops at the level of money motivation. It would appear to be unaware of the New World Order gang's depopulation agenda (coming from much higher up the pyramid of world control power structure) that is "simply" moved along through the motivating power of money.

As Dr. Sydney Singer put it so candidly herein: "Researchers are like prostitutes. They work for grant money. If there is no money for the projects they are personally interested in, they go where there is money. Their incomes come directly from their grants, not from the universities. And they want to please the granting source to get more grants in the future. Their careers depend on it."

Behold the simple equation (money plus ego) which reliably casts its spell of control over so many for so long.

That said, we are thankful to be able to share with you such candid and passionate commentary from several courageous conventional medical professionals about the cancer racket. It surely encourages further development of alternative pathways to good health!

1997 ROBERT RYAN, B.SC.

"Everyone should know that most cancer research is largely a fraud and that the major cancer research organizations are derelict in their duties to the people who support them."

— Dr. Linus Pauling
(Two-time Nobel Prize winner)

Have you ever wondered why, despite the billions of dollars spent on cancer research over many decades, and the constant promise of a cure which is forever "just around the corner", cancer continues to increase?

Cancer Is Increasing

Once quite rare, cancer is now the second major cause of death in Western countries such as Australia, the U.S.A., and the United Kingdom. In the early 1940s cancer accounted for 12% of Australian deaths. [1] By 1992 this figure had climbed to 25.9% of Australian deaths. [2]

The increasing trend of cancer deaths and incidence is typical of most Western nations. It has been said that this increase in cancer is just due to the fact that people now live longer than their ancestors did, and that therefore the increase of cancer is merely due to the fact that more people are living to be older and thereby have a greater chance of contracting cancer.

However, this argument is disproved by the fact that cancer is also increasing in younger age groups, as well as by the findings of numerous population studies which have linked various life-style factors of particular cultures to the particular forms of cancer that are predominant there.

The Orthodox "War On Cancer" Has Failed

"My overall assessment is that the national cancer program must be judged a qualified failure." Thus said Dr. John

Bailer, who spent 20 years on the staff of the U.S. National Cancer Institute and was editor of its journal. [3] Dr. Bailer also said: "The five-year survival statistics of the American Cancer Society are very misleading. They now count things that are not cancer, and, because we are able to diagnose at an earlier stage of the disease, patients falsely appear to live longer. Our whole cancer research in the past 20 years has been a total failure. More people over 30 are dying from cancer than ever before.... More women with mild or benign diseases are being included in statistics and reported as being 'cured'. When government officials point to survival figures and say they are winning the war against cancer, they are using those survival rates improperly."

A 1986 report in the *New England Journal Of Medicine* assessed progress against cancer in the United States during the years 1950 to 1982. Despite progress against some rare forms of cancer, which account for 1 to 2% of total deaths caused by the disease, the report found that **the overall death rate had increased substantially since 1950**: "The main conclusion we draw is that some 35 years of intense effort focused largely on improving treatment must be judged a qualified failure." The report further concluded that "we are losing the war against cancer" and argued for a shift in emphasis towards prevention if there is to be substantial progress. [4]

Most Cancer IS Preventable

According to the International Agency for Research in Cancer: "80-90% of human cancer is determined environmentally, and thus is theoretically avoidable." [5]

Environmental causes of cancer include lifestyle factors such as smoking, a diet high in animal products and low in fresh fruit & vegetables, excessive exposure to sunlight, food additives, alcohol, workplace hazards, pollution, electromagnetic radiation, and even certain pharmaceutical drugs and

medical procedures. But unfortunately, as expressed by medical historian Hans Ruesch: "Despite the general recognition that 85% of all cancer is caused by environmental influences, less than 10% of the (U.S.) National Cancer Institute budget is given to environmental causes. And despite the recognition that the majority of environmental causes are linked to nutrition, less than 1% of the National Cancer Institute budget is devoted to nutrition studies. And even that small amount had to be forced on the Institute by a special amendment of the *National Cancer Act* in 1974." [6]

Prevention Not Profitable To Industry

According to Dr. Robert Sharpe: "In our culture, treating disease is enormously profitable; preventing it is not. In 1985 the U.S., Western Europe, and Japanese market in cancer therapies was estimated at over 3.2 billion pounds [*that's many BILLIONS of dollars, too*], with the 'market' showing a steady annual rise of 10% over the past five years. Preventing the disease benefits no one except the patient. Just as the drug industry thrives on the 'pill for every ill' mentality, so many of the leading medical charities are financially sustained by the dream of a miracle cure, just around the corner." [7]

Desired: A State Of No Cure?

In fact, some analysts consider that the cancer industry is sustained by a policy of deliberately facing in the wrong direction. For instance, in the late 1970s, after studying the policies, activities, and assets of the major U.S. cancer institutions, the investigative reporters Robert Houston and Gary Null concluded that **these institutions had become self-perpetuating organizations whose survival depended on the state of no cure.**

They wrote: "a solution to cancer would mean the termination of research programs, the obsolescence of skills, the end of dreams of personal glory; triumph over cancer would dry up contributions to self-perpetuating charities and cut off funding from Congress; it would mortally threaten the present clinical establishments by rendering obsolete the expensive surgical, radiological, and chemotherapeutic treatments in which so much money, training, and equipment is invested. **Such fear, however unconscious, may result in resistance and hostility to alternative approaches in proportion as they are therapeutically promising.** The new

therapy must be disbelieved, denied, discouraged, and disallowed at all costs, regardless of actual testing results, and preferably without any testing at all. As we shall see, this pattern has, in actuality, occurred repeatedly, and almost consistently." [8]

Indeed, many people around the world consider that they have been cured by therapies which were "blacklisted" by the major cancer organizations.

Does this mean that ALL of the people who work in the cancer research industry are consciously part of a conspiracy to hold back a cure for cancer?

Author G. Edward Griffin explains: "Let's face it, these people die from cancer like everybody else.... [I]t's obvious that these people are not consciously holding back a control for cancer. It does mean, however, that the [pharmaceutical-chemical] cartel's medical monopoly has created a climate of bias in our educational system, in which scientific truth often is sacrificed to vested interests.... [I]f the money is coming from drug companies, or indirectly from drug companies, the impetus is in the direction of drug research. That doesn't mean somebody blew the whistle and said: "Hey, don't research nutrition!" It just means that nobody is financing nutrition research. So it is a bias where scientific truth often is obscured by vested interest." [9]

This point is similarly expressed by Dr. Sydney Singer: "Researchers are like prostitutes. They work for grant money. If there is no money for the projects they are personally interested in, they go where there is money. Their incomes come directly from their grants, not from the universities. And they want to please the granting source to get more grants in the

future. Their careers depend on it." [10]

Money Spent On Fraudulent Research?

A large portion of money donated to cancer research by the public is spent on animal research which has, since its inception, been widely condemned as a waste of time and resources. For instance, consider the 1981 Congressional Testimony by Dr. Irwin Bross, former director of the Sloan-Kettering, the largest cancer research institute in the world, and then Director of Biostatistics at Roswell Park Memorial Institute for Cancer Research, Buffalo, NY: "The uselessness of most of the animal model studies is less well known. For example, the discovery of chemotherapeutic agents for the treatment of human cancer is widely heralded as a triumph due to use of animal model systems. However, here again, these exaggerated claims are coming from or are endorsed by the same people who get the federal dollars for animal research. There is little, if any, factual evidence that would support these claims. Indeed, while conflicting animal results have often delayed and hampered advances in the war on cancer, they have never produced a single substantial advance either in the prevention or treatment of human cancer. For instance, practically all of the chemotherapeutic agents which are of value in the treatment of human cancer were found in a clinical context rather than in animal studies." [11]

In fact, many substances which cause cancer in humans are marketed as "safe" on the basis of animal tests. As expressed by Dr. Werner Hartinger of Germany, in regard to cancer-causing products of the



OVER 500 PAGES
\$29.95 (+S/H)
Code: TBS (1.75 lb.)

THE BIGGEST SECRET

by David Icke

The blockbuster of all blockbusters! With stunning information never before released on the murder of Diana, Princess of Wales.

David Icke's most powerful and explosive book to date. Every man, woman, and child on the planet is affected by the stunning information that Icke exposes. He reveals in detail how the same interconnecting bloodlines have controlled the planet for thousands of years. How they created all the major religions and suppressed the spiritual and esoteric knowledge that will set humanity free from its mental and emotional prisons. It includes a devastating exposé of the true origins of Christianity and the other major religions, and documents suppressed science, which explains why the world is facing a time of incredible change and transformation. *The Biggest Secret* also exposes the true and astonishing background to the British Royal Family and, through enormous research and unique contacts, Icke reveals how and why Diana, Princess of Wales, was murdered in Paris in 1997. This includes information from a close confidant of Diana for nine years, which has never before been made public.

The Biggest Secret is a unique book and is quite rightly dubbed: "The book that will change the world." No one who reads it will ever be the same again.

SEE NEXT-TO-LAST PAGE FOR ORDERING OR CALL TOLL-FREE: 1-877-280-2866

ALICE IN WONDERLAND AND THE WORLD TRADE CENTER DISASTER

Alice in Wonderland and the World Trade Center Disaster

Why the official story of 9/11 is a monumental lie

David Icke



\$29.95 (+S/H)

Code: AIW (1.75 lb.)

Since September 11, 2001, the people of the world have been told the Big Lie. The official story of what happened on 9/11 is a fantasy of untruth, manipulation, contradiction, and anomaly. David Icke has spent well over a decade uncovering the force that was really behind those attacks and has traveled to

the "Hidden Hand" behind the cover story of "Bin Laden did it". Icke takes apart the official version of 9/11 and the "War on Terrorism" and shows that those responsible are much closer to home than a cave in Afghanistan. He explains why 9/11 was planned and to what end. It is vital to maintaining our freedom that the light shines on the lies and deceit behind September 11.

Icke also places these events in their true context as part of an agenda by hidden forces working behind the puppet politicians to create a global fascist state based on total control and surveillance. But it doesn't have to be like this; it does not have to happen. We can change the world from a prison to a paradise and, as Icke explains, the power to do that is within you and within us all.

40 countries in pursuit of the truth.

When the attacks came, it was easy to recognize

SEE NEXT-TO-LAST PAGE FOR ORDERING OR CALL TOLL-FREE: 1-877-280-2866

Children Of The Matrix

How an interdimensional race has controlled the world for thousands of years—and still does!

We are born into a world controlled by unseen forces that have plagued and manipulated humanity for thousands of years. You may look around and think that what you see is "real". But in truth you are living in an illusion designed to keep you in a mental, emotional, and spiritual prison cell.

Icke exposes these forces and their methods of human control and reveals a fantastic web of global manipulation, orchestrated by forces beyond this physical realm. He exposes the hidden bloodlines, through which other-dimensional entities live and operate unseen among us; and he shows how the bloodlines of the royal, political, and economic rulers of today are the same as those who ruled as the kings and queens of ancient times.

The truth is not only out there.

Much of it is right here.

SEE NEXT-TO-LAST PAGE FOR ORDERING OR CALL TOLL-FREE: 1-877-280-2866

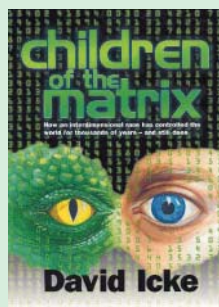

493 pages **\$29.95 (+S/H)**

Code: COM (1.75 lb.)

THE REPTILIAN AGENDA: PARTS I, II & III

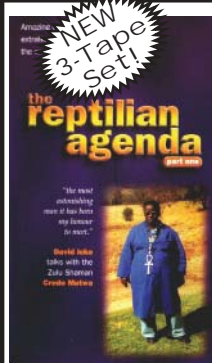

David Icke has produced two amazing videos with the Zulu shaman, Credo Mutwa, who reveals astonishing information which, until now, was only available to the highest initiates of the African shaman tradition.

Credo says, "The world must know this—and know it now!"

He reveals how a shapeshifting reptilian race (the "Chitauli") has controlled humanity for thousands of years and how their bloodlines are in the positions of royal, political, and economic power today.

These videos will re-write the UFO/

extraterrestrial story in a way that will blow your mind. UFO researchers have ignored Africa and therefore ignored one of the greatest sources of knowledge on the planet.

While people still argue over Roswell and the extraterrestrial beings apparently found there, African tribes-people have been interacting with these ET "gods" for thousands of years.

Credo has not only seen dead "greys" many times, he has seen them examined behind their "grey" exterior and he knows exactly what they really look like—and it is nothing like we think!

After making these videos, Credo was visited by two people from Cape Town who offered him 50,000 rand, and a house anywhere in South Africa, if he would agree to never speak to David Icke again and never have anything to do with him. Credo's reply can be imagined!

3-Tape Set: over 6 hours \$59.95 (+S/H)

Code: TRA (2.5 lb.)

SEE NEXT-TO-LAST PAGE FOR ORDERING OR CALL TOLL-FREE: 1-877-280-2866

pharmaceutical-petrochemical industry: "Their constant consumption is legalized on the basis of misleading animal experiments...which seduce the consumer into a false sense of security." [12]

Imagine What Could Be Achieved

The next time you are asked to donate to a cancer organization, bear in mind that your money will be used to sustain an industry which has been deemed by many eminent scientists as a qualified failure, and by others as a complete fraud.

If you would like to make a difference, inform these organizations that you won't donate to them until they change their approach to one which is focused on prevention and study of the human condition. We have the power to change things by making their present approach unprofitable. It is only through our charitable donations and taxes that these institutions survive on their present unproductive path.

References

1. d'Espaignet, E.T. et al., *Trends In Australian Mortality 1921-1988*, Australian Government Publishing Service (AGPS), Canberra, 1991, p. 33.
2. Australian Bureau of Statistics, *Causes Of Death, Australia 1992*, ABS, Canberra, 1993, p.1.
3. Dr. Bailer, speaking at the Annual Meeting of the American Association for the Advancement of Science in May 1985, as quoted in Bette Overall, *Animal Research Takes Lives, Humans And Animals BOTH Suffer*, NZAVS, 1993, p.132.
4. Robert Sharpe, *The Cruel Deception*, Thorsons Publishing Group, Wellington, U.K. 1988, p.47.
5. Robert Sharpe, op. cit. 1988, p.47
6. Hans Ruesch, *Naked Empress—The Great Medical Fraud*, CIVIS, Massagno/Lugano, Switzerland, 1992, p.77.
7. Robert Sharpe, op. cit. 1988, p.65.
8. as quoted in Hans Ruesch, op.cit. 1992, p.65-66.
9. Edward Griffin, *The Politics Of Cancer*, audio cassette, American Media, 1975, available from CAFMR (\$14).
10. Sydney Singer, *Medical Demystification (M.D.) Report*, Vol.1 No.1, p.5, Medical Demystification Crusade, 1992, CA, U.S.A.
11. Irwin Bross, as quoted in Robert Sharpe, op.cit., 1988 p.179.
12. Dr. Werner Hartinger, in a speech given at the 2nd International Scientific Congress of the Doctors in Britain Against Animal Experiments (D.B.A.E.), London, 24 Sept. 1992.

Understanding Your Bio-Electric Sensing Machine

Editor's note: The new/old theme of electro-medicine—highlighted in this month's front-page feature story and expanded in several other articles in this issue—begs the sharing of the following insightful two-part dissertation from 1997, especially for our newer readers who may not have the benefit of so many of our past presentations of spiritual messages "received" from Master Teachers of the Higher Realms.

Furthermore, the "subtle energy" physics discussed so simply yet profoundly herein may assist readers looking for insights in trying to understand the true mechanisms through which electro-medicine's seemingly exotic devices, like Rife machines, could be so dramatically effective in restoring health. For example, consider the following point that opens a doorway to treating causes rather than effects:

"These ones trained in your so-called medical schools (again under the control of those drug companies) can prescribe electrochemical mixtures (drugs) which will cause reactions and responses in the physical as your body tries to deal with the chemical invader. They can offer electromagnetic radiation treatments to kill living tissue (both cancerous and non-cancerous). But these 'medical professionals' do not understand the non-physical effects that their treatments have on the light-body part of the human apparatus. Therefore they, for the most part, end up treating the symptom(s) instead of the TRUE cause(s)."

Indeed, even for some who claim to be familiar with electro-medicine, often their explanations for what's going on focus too much on contriving purely physical mechanisms rather than appreciating that non-physical, higher-dimensional processes and principles underlie and govern ALL that is manifest in the physical.

As the planetary frequency continues to rise at this time of the great Awakening and Great Cleansing, and all of us upon Mother Earth experience various effects stimulated by these incoming energies associated with a dimensional upshift, it is helpful to review

this most instructive lesson from Master Hilarion. Our physical body—that machine which most of us just take for granted—is indeed a most amazing creation and, as Master Hilarion so skillfully points out, can be very helpful in our quest for inner peace and fulfillment through the sorting out of those often nagging fundamental questions about direction and choices and purpose.

The following is Chapter Four in Volume II of WISDOM OF THE RAYS: The Masters Teach. And for those of you who are wondering: yes, a Volume III will eventually be a reality. How soon that happens is a matter that depends upon the usual things that bring such a project into manifestation. Volume III will continue the collection of spiritual messages from where Volume II left off, up to the present. The wonderful, heartfelt appreciation you have so often expressed about this ongoing series of messages from the Higher Realms is what keeps the momentum going and expands their reach worldwide—in both English and French editions, so far.

5/17/97 HILARION

Good afternoon, my friend. Please release of the emotional charge and allow the energy to flow naturally and smoothly. It is I, Hilarion, of the Fifth Aspect of Creator's Spectral Expression. I come in The Light of Holy God of Lighted Creation. I come as the Cohan (Master Teacher) of the Emerald Ray.

Ones on your planet are greatly concerned with the physical well-being of the body in which they are housed. Here we shall give forth some insights that will help to clarify the causes of the conditions that ones are experiencing. For most this will not be "comfortable" reading because the reasons for illnesses are most often other than what a person wants to hear, let alone accept.

The physical body is "merely" a conduit for the interaction into and the interfacing with the physical experience. I say "merely" because that body is a most exquisite creation indeed and poorly

understood by your current level of so-called medical science.

It is a self-contained bio-electric machine that is quite suited to handle a wide array of energy patterns and frequencies that allow for the animation and coordination between the physical and the non-physical. The body's electrical system is quite sensitive and balanced in such a manner as to have the capability to respond and alter according to emotional desires of the one controlling the mechanism.

YOU ARE NOT YOUR BODY! "You" are the one inhabiting the mechanism and it responds to your desires. There is similarity between "you" inhabiting and operating your body, and the process of sitting behind the wheel and driving your automobile.

The body, for the most part, is self regulating and will tend to run quite well in an "autopilot" mode. However, there come times of experience where the body is subjected to threat, such as physical injury, when it will offer a reactionary response to the danger and bring focus to the impending physical condition.

An example of this reactionary impulse would be to quickly remove one's hand from a hot stovetop. The body will retain information that will help one to avoid future damage and will offer a cautionary warning to the host (you) when the hand even gets close to a warm object.

This mechanism is part of the design of the body so that more primitive (lesser aware spiritually) users will be able to persist long enough in the physical without demise so that there will be adequate time sequence for growth.

This is the situation wherein one will tend to live instinctively and obey the signals of the body such as hunger, thirst, and rest. Ones will seek out the satisfaction of these basic needs so that they can experience as fully as possible.

As entities begin to grow more and more aware spiritually, they will begin to come out of the fog and into a more reasoning condition wherein mental anticipation of the future need for food will be recognized and planned for through storage.

This is the point where ones begin to awaken enough to realize that there is something more to the experience than to just exist and search out survival needs. This is where ones begin to reason with others the value of working together with one another in order to quiet the distractions and concerns of the body. This is where there occurs the first spark of sensing that man is more than a reactionary animal and that there is an inner desire to explore this awareness.

As cultures and beings evolve, there comes the need for Guides and Wayshowers to interject more and more of the true nature of the physical experience. While Esu "Jesus" Sananda is a good example of one such Wayshower who came to your planet 2000 years ago, MANY have come at this present time. These more advanced ones will volunteer for the challenge of fulfilling this task and will choose to take on a body in the physical to bring forth the all-

important messages concerning the non-seen-but-felt spiritual connectedness of mankind.

These awakening nudges will often cause great emotional stirrings in the body. Ones will not know how to handle these energy surges at first, because they are subtle yet strong in their grip upon the physical apparatus. The surges will cause an array of sensations within the physical which, in turn, can provide the physical entity with guidance as to what is right versus what is wrong.

Much like the reactionary impulses to avoid physical danger, the body will offer reactionary impulses in response to other kinds of situations, which can nudge you to go toward that which will offer comfort and warmth. And in the case of the presentings of spiritual truth, the body will offer the best it can in the way of "gut felt" responses to that which is being offered.

"How", you may ask, "does the body do

this?"

The physical part of the body is but "only" one small part of the entire apparatus that makes up the entire, functioning, bio-electric machinery. Just like in a computer, you have all the physical components—the main processor, the memory modules, the peripheral (audio and video) circuit boards, and the interconnecting wiring. And yet, more fundamentally, the computer still requires electricity (energy) operating in very focused ways in order to function and come to life at all.

In the case of the body, there are various electrical counterparts associated with each physical part of the body, including each organ and each individual cell. More fundamentally, there is a coordinated electromagnetic (LIGHT) energy field that encompasses the entire physical body. Some can actually see this "luminous" electromagnetic field under the proper conditions and call it the aura.

Your body's electromagnetic field interacts with the electromagnetic fields emanated by others and will respond to the various frequencies of these fields.

This is when you ones will say that you KNOW you can trust a person immediately; you don't know why but you can just "feel" it. This is why, when another comes offering true spiritual knowledge, you "feel" it within your "gut". You are responding to the higher-frequency energies flowing into the electromagnetic field of your body. The body then responds with a desire to find more of what causes this reaction.

This is also the reason why some ones will be frightened of you. They will know that you hold truth and they cannot hide their trickery from you and that you will, in time, see through their games. These ones have resisted the spiritual path, having not yet learned to recognize that there is value in the experience. These ones have an energy signature that is much lower in frequency. They are usually the ones clinging to the physical-material for their comforts and security. They are much like the animal who has to hoard and hide food from others who might take it away—not realizing that there are infinitely abundant sources of nourishment for both the physical apparatus and, more importantly, the soul (the non-physical, God-like, thought projection of Creator Source).

When ones turn from their purpose, there come the "STRESSES" of the life experience. This unbalanced condition is a signal to you so that you can stop to evaluate where you are heading and compare that to where your heart tells you that you should be heading. The heart knows the direction which will garner fulfillment.

More accurately, it is the emotional

The HeartMath Solution AUDIO Book by Doc Childre & Howard Martin

- WHAT IF YOU COULD EASILY—
- MAKE BETTER DECISIONS?
 - ENHANCE CREATIVITY?
 - SLOW-DOWN AGING?

intelligence—which has more impact on our emotions, our mind, and our physical health than was ever thought possible! In this audio, the authors offer astonishing proof that the heart has an intelligence, one that

You can. Simply by understanding your heart's profoundly affects our mental and physical health. When we engage the power of our heart's intelligence, then, and only then, can we make the most of our health and our minds. These life-altering techniques will show you how to deepen the qualities long associated with the heart—wisdom, compassion, courage, love, strength, and joy.

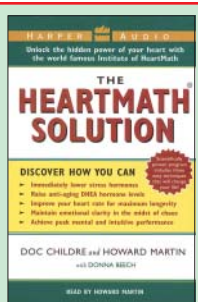

3-hours \$18.00 (+S/H)
Code: HMS (0.5 lb.)

This audio abridgement is approved by the authors.

SEE NEXT-TO-LAST PAGE FOR ORDERING OR CALL TOLL-FREE: 1-877-280-2866

Everyday Enlightenment: The Twelve Gateways To Personal Growth

Here is Dan Millman's magnum opus—the most complete presentation of his teachings, showing how to live as a peaceful warrior, how to actually practice a more enlightened way of life. *Everyday Enlightenment* presents twelve "gateways" or arenas that radically redefine the meaning of success and the purpose of our lives. These twelve gateways: keys to worth, will, energy, money, mind, intuition, emotions, fear, shadow, sexuality, heart, and service, represent twelve books in one, a clear map of the territory of human potential.

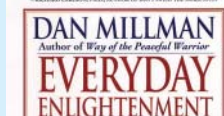

ON SALE!
only \$10 (+S/H)
While Supplies Last

~~\$14.99 (+S/H)~~
Code: EDE (1.0 lb.)

Comments by Dan: Those who have read most or all of my books know that each has a different purpose, and expresses another piece of the puzzle of personal and spiritual growth. Like the story about the five blind men who came upon an elephant and perceived a different kind of creature depending on whether they touched the elephant's ear, tail, trunk, or leg—someone who reads *The Life You Were Born To Live* may see me as a "numerologist". Someone who reads *Divine Interventions* or *Body Mind Mastery* or *The Laws Of Spirit* will have a completely different experience.

Everyday Enlightenment provides, in a single volume, the most complete map to the major practical and spiritual challenges (and solutions) we face in everyday life. It culminates with a final chapter worth far more than the price of the book: "The Practice Of Enlightenment"—a radical approach to living wisely and well.

SEE NEXT-TO-LAST PAGE FOR ORDERING OR CALL TOLL-FREE: 1-877-280-2866

(electromagnetic) energy center associated with the heart that is attuned to both your purpose from Creator Source and the impinging emotional currents of the ever-changing electromagnetic pulse-wave universe in which you exist. This heart energy center responds by instinctively offering that which will help you to discern your most satisfying path in life.

When you first start heading in a direction that is not fulfilling to the purpose for your being down there, you may or may not notice the subtle annoyance that you feel. But be assured that it is there. This causes slight distortions in the energy field of the body as you resist the natural flow of your experience. These distortions are what you ones refer to as "stress" and the corresponding worry and frustration is a by-product of the electromagnetic distortions in the non-physical part of the body.

If these distortions are allowed to persist, they will cause physiological malfunctions within the body. The physical body will respond to the out-of-balance (out-of-phase electrical impulses) condition of the electromagnetic energy field of the body. This will result in negative physiological changes within the body if the condition persists—such as colds, flu, cancers, and especially that #1 cause of death: HEART dis-ease.

Please be aware that the direction of the individual always starts with a thought and a decision. When ones are considering choices of action is when ones should really make an effort to monitor the response of the heart or "gut" while evaluating their choices. Some do this automatically and may cause frustration in others because there will be times when the only reason they can offer for an action is: "I don't know; it was 'just' a feeling." These perceptive ones have learned to recognize and utilize the "bio-feedback" that is being offered to them.

When there is illness of any sort in the body, you can be assured that the one experiencing the illness was not paying attention to the signals offered through the heart energy center. There are choices and decisions associated with the condition that allowed for the stress to persist on and on until there is great unbalance within the physical, causing improper coordination between the various energy centers, and thus the body will not regulate itself properly.

When ones can isolate that which causes them "stress", they will be looking for that which has a decision or choice associated with it and would be wise to perhaps re-evaluate or look for that which they are resisting. Usually those things that the heart desires by way of growth have responsibility associated with them, and

ones know analytically that there are often "growing pains" associated with such responsibility—as the primitive, ego-based, reactionary mode of living is replaced with a freer, more personally responsible mode of living.

Many will go through many life experiences without ever recognizing the connection between the physical condition and the non-physical stress—only to cast blame upon another for *their* lack of physical balance. YOU each are creator of YOUR experience, either through deliberate action or passive reaction. Your physical condition is no exception!

Ponder upon these words, for they are offered in love and NOT with the intent to be offensive or hurtful. At this time many are crying out for assistance with the physical condition of the body. You will see that there is great value in finding within yourselves the TRUE cause(s) of any unbalanced situation.

The subject matter discussed here is far from complete. It is offered as a general overview so that ones can come into awareness of self in a general, yet more balanced, manner. There shall be more coming forth on this subject of the physical body's functioning. Please be patient and understanding. Thank you!

I am Master Hilarion. I represent the Heart Center of God. In Light and Love, Salu!

5/24/97 HILARION

Good afternoon, my scribe. It is I, Master Hilarion, of the Emerald Ray of Creator's Spectral Desires. I come within the Wholeness of The One Light, Creator Source. Let us please continue from last we wrote, for there is great interest and desire for this information at this time.

We last spoke about the general overview of the basic functioning and interactions of the physical body. The various energy centers of the body function in a harmonious and balanced interchange in carrying out the regulation of the various

physical-functioning organs and cellular matter that make up the entirety of the body. There must be two-way communication, in a timely manner, between the physical body and the non-physical counterpart we will refer to as the light-body (light being electromagnetic pulse-wave energy) in order for the body to respond to the delicate fluctuations of the electrical impulses generated by each cell of the body.

This exquisite communication is accomplished through what you ones would call superconductivity. We will here broadly define superconductivity as the conduction of electrical energy without resistance to that flow of energy.

In the world of "science", ones are having trouble achieving this superconducting state utilizing just basic metal and ceramic compounds, even at temperatures just slightly above where the conditions are most favorable (very cold). Yet, in Nature (God manifest), it is happening all the time right before your eyes. (In fact, it is happening IN your eyes, for that matter!) And in the body, this superconductivity occurs at temperatures averaging 98.6° Fahrenheit—and higher when the body is fighting foreign invaders.

The problem is that the current perceptions of "physics" are based upon assumptions which would appear to be true, but actually only include half (at best) of the picture. This is why your typical mainstream scientists are having so much trouble duplicating (or even realizing the true physical nature of) the world in which they live. But here I am digressing from the lesson for today, so let me return to that subject.

Each individual type of cell is attuned to very specific frequencies and will respond to the regulating currents of the light-body energy pulses. There is an underlying unique frequency signature associated with EACH individual on the planet that will keep each of you, to some extent, electrically isolated from one another, so that the direct electrical functioning of your

The Masters And The Spiritual Path

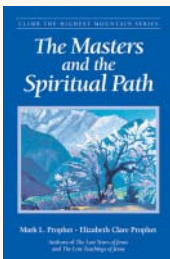

You have friends in high places!

There are Masters who have come out of all the world's great spiritual traditions. These great Lights have graduated from Earth's schoolroom. Now they come to show us the pathway home.

The Masters tell us that they are examples and not exceptions to

the rule. We, too, are destined to fulfill our life's purpose and reunite with Spirit.

In this intriguing work you will discover valuable keys to your own spiritual path. You will learn about the function of the Spiritual Hierarchy and the role of the Masters of East and West. Includes a unique meditation on the bliss of union with Spirit and a breathing exercise to help you balance and expand consciousness.

SEE NEXT-TO-LAST PAGE FOR ORDERING OR CALL TOLL-FREE: 1-877-280-2866

OTHER VOICES

BY GEORGE HUNT WILLIAMSON
& TIMOTHY GREEN BECKLEY

The author was one of the original witnesses at the meeting between contactee George Adamski and Orthon from the planet Venus. Williamson claims he also had contacts with aliens and received transmissions over his radio from friendly extraterrestrials. Others have claimed the same. Senator Barry Goldwater reportedly heard mysterious signals on his ham radio and our own astronauts have reportedly picked up messages not transmitted from Earth.

Other Voices is essentially a reprint of *The Saucers Speak*, by George Hunt Williamson and Alfred Bailey, originally published in the 1950s. Much of what the authors report has come to pass. Warnings of aliens about nuclear war and environmental doom remain urgent.

SEE NEXT-TO-LAST PAGE FOR ORDERING OR CALL TOLL-FREE: 1-877-280-2866

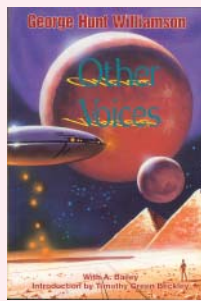

\$12.50 (+S/H)
Code: OTV (0.75 lb.)

Nostradamus: Predictions Of World War III

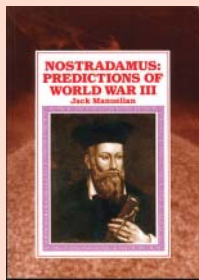

After the 9/11/01 disaster at the World Trade Center, there is a renewed interest in what the great seer Nostradamus had to say. This book is a serious study of his predictions, based upon the author's research into the original manuscripts. His work details the struggle that is going on in the Middle East and the ongoing conflict between the Christian world and the Islamic world. Jack Manuelian has combed through the prophecies of more modern seers, pointing out how they may agree with what Nostradamus had to say. He offers hope for mankind, but admits that it is troubled times we live in. What will be the outcome? Read the book and decide for yourself.

\$15.00 (+S/H)
Code: NOST (1.0 lb.)

SEE NEXT-TO-LAST PAGE FOR ORDERING OR CALL TOLL-FREE: 1-877-280-2866

THE PHILADELPHIA EXPERIMENT & OTHER UFO CONSPIRACIES

BY BRAD STEIGER

In 1943 the Navy accomplished the teleportation of a warship from Philadelphia to Norfolk by successfully applying Einstein's Unified Field Theory. The experiment also caused the crew and officers of the ship to become invisible, during which time they were launched into a time-space warp. One survivor tells his amazing experience.

SEE NEXT-TO-LAST PAGE FOR ORDERING
OR CALL TOLL-FREE: 1-877-280-2866

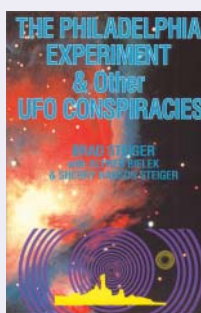

\$15.00 (+S/H)
Code: PEUC (0.75 lb.)

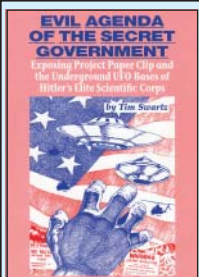

EVIL AGENDA OF THE SECRET GOVERNMENT

BY TIM SWARTZ

Exposes Project "Paper Clip" and the underground UFO bases of Hitler's elite scientific corps. Elements of the CIA and the Secret Government have imitated real alien abductions to convince the public of interplanetary invasion so New World Order gang can rule the Earth unchallenged.

Project Paperclip was the secret plan that took Nazi scientists and psychiatrists out of Germany and into the upper echelons of the U.S. governmental, scientific, and academic realms.

SEE NEXT-TO-LAST PAGE FOR ORDERING OR CALL TOLL-FREE: 1-877-280-2866

body will not interfere with the direct functioning of another person's body.

This is the "genetic signature" of the body, unique to the DNA structure or blueprint of each cell. This is a "plasma shielding" that the body exists within. It will allow physical matter to pass through, while shielding out specific frequencies and wavelengths.

Without this shielding, ones would empathically alter the state of one another. There are ones who can tune into the various frequencies associated with this energy field, and if not careful, make themselves quite sick (unbalanced) if they are tuning into one who is out of balance.

When ones are in an out-of-balance condition, the energy field tends to be compromised in that it will lower in frequency and in intensity. This is a condition wherein you ones become more susceptible to manipulations by those who specialize in the "black arts". These dark ones will alter their frequency to match the lower-frequency state that you enter when in these "stressed" states. Know that these dark ones operate ONLY in the lower spectrum of the physical range of existence.

When you move up in frequency, you are moving beyond the range of their influence. This is why we of the Lighted Hosts of God will urge you to keep your Light shielding in place and fortified.

While each physical body is isolated in certain frequency ranges, each entity is also connected in other HIGHER frequency ranges that will allow for the communication with the rest of the universe (God's infinitely creating Mind). As we spoke about in last week's writing, the creative desires are projected out from the heart energy center and are focused with the mind. The greater the desire, the quicker the physical manifestation of the desire.

This mode of creation exists and works outside of the limitations of moral and ethical beliefs of the individual. This is to say it works for everyone regardless of their morals or beliefs. This is a basic Law of Creation: Go forth and CREATE, expand, and GROW!

There are ones on your planet who will manifest money and power without regard for who they step on, in order to reach their goals. Their desires often manifest quickly because they are not easily distracted with the Conscience that the average person has to contend with.

These ones, who are so physically focused and self-isolated from their Conscience (inner guidance from their Higher Self), will achieve a state where they get to the top of the mountain and will have everyTHING (physical) that they desire—only to find that there is still an inner lacking that is not satisfied. These ones are taking to extremes, one aspect of creating, and will, in time, either disintegrate their souls completely, or rebound back into the Light Source who created them—then wiser, for they know then where value IS NOT!

You focus your desires and send them out through the heart, and then the universe responds. Yet you never seem to get what it is you are wanting. Therefore you dismiss these words as fanciful delusions of a lost soul.

NO! They are NOT!

You ones fail to monitor your thoughts CAREFULLY! You will send out conflicting signals, and thus negate the energy pulses. You will say: "I want more money!" And then, in the next breath (or thought) you will say: "But, I never get it." Do you see that the one thought cancels out the other? Your vacillating heart will send out both, and the net sum will be zero—or quite a bit less than you "thought" you were creating!

The seeming lack of clarity and single-mindedness of thought and focus usually comes from a conflict between what you consciously desire and what your Higher Self is desiring in the way of growth. And that Higher Self is doing battle with the ego-based self which desires comfort and satiation of physical desires.

This causes the kinds of stress that you ones feel, usually in the

heart area of your chest. While this lower, ego-based self serves a self-preservation purpose in the primitive cultures, it must be overcome if you are to ever move beyond the limitations that hold you from reaching through to Higher levels of realization.

The ego's reactionary impulses will serve you physical "warnings" to obey, by offering physical reactions or pains if you do not follow what it desires. Much like the warning sensations felt when your hand comes into close proximity to a hot object, the ego-based reactionary self will attempt to cause you to avoid situations that could lead you to override the ego's functioning. This "war" is perhaps the greatest challenge you ones face in the physical experience because there are great efforts on the part of the dark ones to hold you from progressing through that physical classroom.

When you live in fear, you live in a reactionary state that will, at best, only serve the ego's desire for self preservation. However, your Higher Self knows the functioning of the ego and will offer to you challenges that will shed light upon this fact. Most often the "clash" which results from encountering the lessons of this learning process will cause physiological changes and unbalanced conditions within the body. These reactions could manifest in many different ways, from sudden weight gain or loss, to colds and flus, or even cancer.

Most elderly people in poor health are in that deteriorated condition due to years and years of ignoring the "small" stresses and allowing them to build and accumulate into conditions of cancers or other various disease ailments. These ones will often be very unhappy in general, and will reflect this in their physical demeanor, appearance, and voice.

Middle-aged people on this same path will often exhibit physical symptoms of old age (such as prostate troubles or menopause) at an "early" age. The individual always has a choice to turn around the physical conditions of the body, for it will respond miraculously to a re-balanced mental state wherein the head and heart can live in harmony.

Teenagers and younger adults tend to act irrationally to their inner conflicts and will lash out and hurt those around them in both physically and mentally abusive manners. When they realize that this behavior is not acceptable, they will begin to internalize their frustrations and hide them from the world. Meanwhile those stresses begin to manifest in the body, in later years, as degenerative malfunctions like cancers and organ failures.

You may be asking: "How can one avoid this, or turn it around?"

First there must be a desire for inner

balance. This means that you have to either confront the garbage that the ego-self holds onto, and see it for what it is, and come to grips with the fact that YOU are responsible for YOUR condition, and accept the responsibility for that which you have created. Or, you can (and this is possible though difficult) simply insist on balanced physical health, and focus the mind and heart on that singularity with the entire passion of your heart, and don't listen to those who would hold you down, for they are the puppets and tools of the adversary.

Particularly within the framework of policing controls set up by those dark ones who own the drug companies and make great profits from a drug-based "health" business, medical "science" has yet to (be allowed to) discover the correlation between the various electromagnetic energy fields of the body and the body's physical functioning—let alone perceive the connection between (and the true impact from) this "clashing" of the mental reactionary ego with the Higher Self or soul connection. Therefore there is, more often than not, misdiagnosis of the cause for a condition that is manifesting in the body.

These ones trained in your so-called medical schools (again under the control of those drug companies) can prescribe electrochemical mixtures (drugs) which will cause reactions and responses in the physical as your body tries to deal with the chemical invader. They can offer electromagnetic radiation treatments to kill living tissue (both cancerous and non-cancerous). But these "medical professionals" do not understand the non-physical effects that their treatments have on the light-body part of the human apparatus. Therefore they, for the most part, end up

treating the symptom(s) instead of the TRUE cause(s).

These ones are usually well intending and well educated in the physical structure of the body (to a point), yet they would need to study fundamental electrical science and molecular physics to great depths in order to come into a more complete understanding of what is taking place around the body. And even then, they would still need special abilities and talents in order to directly perceive these all-important energy fields of the body.

You will have to follow your own Guidance, and be responsible for the choices and decisions that affect both the quality and length of your stay in the physical. Do keep in mind that what you voice with your mouth is often in conflict with what you radiate from your heart. You may be able to hide behind words, but the heart will give you away every time. And for those who tune into the heart energy emanations, they will know you and they will know when you are out of balance and off purpose.

And for those of you who like to deny this to yourselves, you can look to that which manifests in your life: Is your current state of "living" this life's experience something that is fulfilling to you, or is it full of stress and frustration?

May your heart be your guide, and may you learn to listen with the heart and project forth from those inner satisfying desires that bring forth balance. I am Hilarion, Master Teacher and Healer, come in the Radiant One Light of Creator Source so that His promise to you may be fulfilled—and so that I, too, may grow in wisdom of experience. Salu! △

"This is all just a front. Actually, I'm a faith healer."

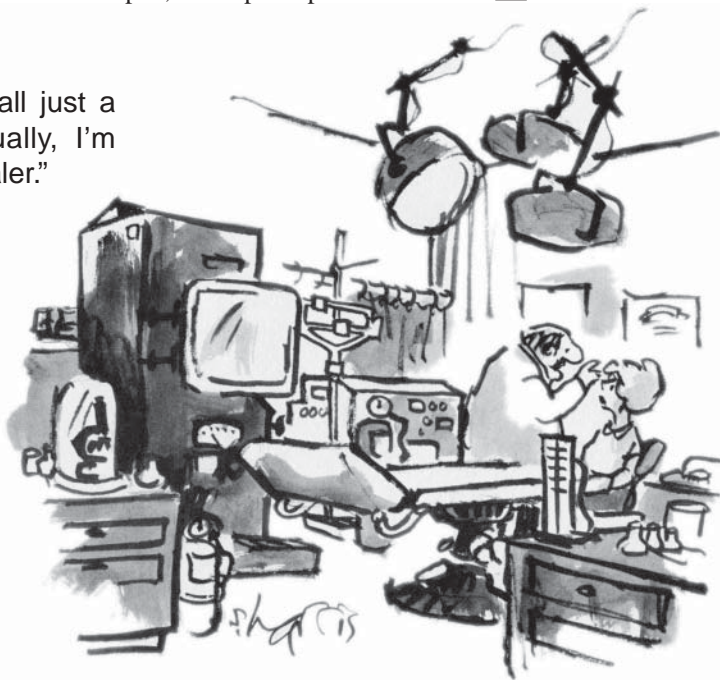

Blindness, Mad Cow Disease, And “Canola” Oil

Editor’s note: Something’s going on right now that’s VERY fishy—figuratively speaking. And it’s serious enough, especially given the health theme dominating much of this issue of The SPECTRUM, to warrant our revisiting a potent article we last shared with you way back in December of 1999.

The curious situation is that so-called “Canola” oil is showing up in the ingredients list of more and more products all of a sudden. And for at least some of those items, it would seem this ingredient was forced into the mix under some kind of edict!

*I (E.Y.) already commented on this matter recently, in the April 2003 issue, in the process of introducing a fine article from the Edgar Cayce group’s magazine titled **What Are We Doing To Our Food?** wherein I said:*

“Alarming things are happening to our foods these days. And if we’re not aware and vigilant enough about such matters to ‘vote with our wallets’ to send messages back to the purveyors of such unconscionable shenanigans, then guess what—we deserve the poor health and medical complications we get as a result....

“For example, if you’re vigilant about reading ingredients, you’ve probably noticed nasty poisons like “Canola” oil, MSG, and Aspartame [and I forgot about aluminum in so many bakery goods at the time of that writing] creeping into products—even so-called and more expensive “health” products—where they never found residence before and surely don’t belong. Longtime readers with good memories will be quick to point out that these three pivotal ingredients have all been the subjects of past ominous articles within our publication. And for very good reasons!

“When a longtime staple of the food shelf, previously with a very healthy ingredient like olive oil, has now quietly switched to ‘Canola’ oil—while still prominently bragging about their ‘fine old Italian recipe’—one can’t help but wonder what nonsense is REALLY going on. Students of conspiracy recognize the

trademark clues of the New World Order gang’s calculated high-level agenda in play, to slowly but surely compromise the health of, well, the actively health-conscious consumer.

“Who better to target? This is the same uppity portion of the citizenry most feared by the world control misfits because these are the people most likely to be actively protesting, say, the war in Iraq. But only if their health permits. An unhealthy public is a docile public of easily herded sheep.

“Further, if such poisonous ingredients are, as an incentive for use, nearly ‘given away’—perhaps at dirt-cheap prices—to key manufacturers more infatuated with profit than, say, their ‘fine old Italian recipe’—then the temptation becomes practically irresistible. From a pure ‘business’ point of view, it’s a captivating situation for such manufacturers, who’ve sold their souls (and the earned trust of loyal customers) to become—knowingly or unknowingly—agents for the higher-level depopulation agenda of the depraved New World Order elite.”

But what finally tipped the scales, in terms of deciding to again share the following article with you, was a recent shopping trip wherein a whole bunch more items, that were always “Canola” oil-free, now list this dubious intruder in their ingredients. What’s the rush all of a sudden to get this into so many products?! It sure takes a lot longer to shop when, each trip to the store, you have to now check the ingredients lists of staple items that for years previously hadn’t gone down this road of selling out.

Originally the following article was bravely published in the March/April 1996 issue of the often excellent Perceptions magazine, which appears to be no longer in production.

The finely aware author, John Thomas, draws a number of important parallels between Canola and soy—noting that the impact on our health from the Canola scam is 1000 times nastier than from the soy fraud. Those of you familiar with Edgar Cayce may remember that he,

likewise, cautioned about these two items. (We presented a lengthy and alarming discussion about soy in our July 1999 issue of The SPECTRUM.)

In the debate section of this article (later on), it is amusing to watch the familiar tactics of establishment scientists feverishly at work, as prostitutes for Big Business, quoting their “religious books” in order to discredit what is both beyond their understanding and a major threat to their way of life. Their antics recall all those sanctimonious tobacco executives lying to Congress about the health risks of cigarettes.

The kind of “subtle energy” or “higher vibrational” considerations which are integral to what author John Thomas talks about herein are—like Rife, Reich, and related technologies addressed in our front-page feature story—the “energy medicine” of the future and give a whole new (and much more accurate) meaning to the phrase “you are what you eat”. Edgar Cayce had much to say on this matter, a subject which is only now beginning to be appreciated by ones willing to foresake the shackles and blinders which mainstream scientific training religiously imposes—especially at advanced levels.

With that idea of “subtle energies” in mind, it is important to note a subject which John Thomas does not cover herein. That is, longtime readers of The SPECTRUM would be wise to entertain a possible link between deleterious effects on your mind and body that electromagnetic shenanigans like the HAARP system are capable of producing, and such effects perhaps being enhanced or amplified when even a small amount of Canola oil is present in your body. Might that be the REAL reason for getting Canola oil into enough different products—especially among the so-called “healthy” products—so that one or another of them will be sure to “infect” each of us?

The duplicity of the scam being perpetrated by the mind-control (marketing) departments of big dietary

businesses is exactly to target and convince those MOST conscious about their health to embrace these questionable ingredients as healthy for you. The sleeping masses are not a problem for the world elite controllers, but those of you who are naturally driven to become informed, and then call their bluff, ARE a BIG threat!

The original Perceptions article carried the introductory statement: "This excerpt from John Thomas' new book Young Again! How To Reverse The Aging Process, published by Promotion Publishing, San Diego, has been edited especially for Perceptions." Some of you may enjoy reading John's longer story in that still-available book format.

So—just what IS the "magic" about Canola oil that is making it appear in so many products now? While we don't have any concrete answers, justifiable suspicions run high—just like with the chemtrails sprayings going on over our heads. And one thing's for sure: after you read the following, you'll be checking the ingredients lists of your favorite food products a lot more carefully!

MARCH/APRIL 1996 JOHN THOMAS

Millions of people have suffered the loss of their vision from glaucoma, a disease involving atrophy (deterioration) of the optic nerve. For years, "experts" have been telling us that glaucoma results from fluid-pressure buildup in the eye that causes the optic nerve to deteriorate. This theory was based on an incorrect medical model: They were wrong!

Now the experts have admitted that this is not true and have given birth to a new theory. According to it, glaucoma is instead caused by a deficiency of oxygen and blood flow. Finally they are on the right trail. In the end, they will discover that glaucoma is the result of insufficient blood flow due to agglutination (clumping together) of the red blood cells, and waste buildup in the cells and intercellular fluids.

These blood-corpuscule clusters cannot squeeze through the extremely tiny capillaries in the posterior of the eye, so cannot deliver oxygen to the mitochondria. Mitochondria are microscopic bodies inhabiting the cells of all animals. They contain enzymes responsible for the conversion of food to useable energy. They produce and burn the energy-carrying molecule adenosine triphosphate, ATP.

This is what the problem has been all along, and if people continue to eat soy and "Canola" oils, a lot more of them are going to experience vision

irregularities—like retinitis and macula lutea degeneration. (The macula lutea is an area in the eye near the center of the retina in which visual perception is most acute.) Soy oil contains phytohemagglutinin, PHG, a toxic biochemical that causes blood to clot and combines with impurities to form plaque, obstructing capillaries. PHG numbs immune-system T-cells, alters hormonal activity, and slows vital organ function. Its effects are cumulative.

Death of the mitochondria in the cells in the posterior of the eye is due to oxygen starvation, sodium toxicity, and waste accumulation. When the mitochondria die, the cells die, and the posterior eye tissues atrophy. In this respect, glaucoma has much in common with hair loss, Alzheimer's disease, multiple sclerosis, cerebral palsy, and hearing problems.

[Editor's note: Some of you may be aware that there has been a tremendous increase, in recent years, in the number of senior citizens diagnosed with macular degeneration. Care to guess why?]

There are several things a person can do to reverse these debilitating conditions. Biologically friendly water is basic to all rejuvenation, as is fresh, viable food. Detoxification of the tissues and body fluids is accomplished with yucca extract, Kombucha tea, PACs, and colon therapy. (Biologically friendly water is water resonant at 7.8 hertz, or Earth frequency—pure, highly charged, and magnetic in its strong right-spin molecular charge; Kombucha tea is a revitalizing brew made from a fungus-like organism; PACs are proanthocyanidins, which are plant-derived antioxidants, free-radical scavengers.)

Rape Seed Oil Or "Canola"

"Canola" is a coined word. It appeared out of nowhere and is not listed in any but the most recent reference sources.

[Editor's note: This fact alone ought to raise a flag of caution as to who is behind such marketing.]

The flip side of the Canola coin reads: "rape"! You must admit that Canola sounds better than rape. The name Canola disguised the introduction of rape oil to America.

Canola oil comes from the rape seed, which is part of the mustard family of plants. **Rape is THE MOST TOXIC of all food-oil plants.** Like soy, rape is a weed. **Insects will not eat it; it is deadly poisonous! THE OIL FROM THE RAPE SEED IS A HUNDRED TIMES MORE TOXIC THAN SOY OIL!**

Canola is a semi-drying oil that is used as a lubricant, fuel, soap, and synthetic rubber base, and as an illuminant for the slick color pages you see in magazines. **It is an industrial oil and does NOT belong in the body!**

Canola oil has some very interesting characteristics and effects on living systems. For examples, it forms latex-like substances that agglutinate the red blood corpuscles, as does soy, but MUCH more pronounced. Loss of vision is a known characteristic side-effect of rape oil, which antagonizes the central and peripheral nervous systems—again like soy oil, again worse. The deterioration takes years, however.

Rape (Canola) oil causes emphysema, respiratory distress, anemia, constipation, irritability, and blindness in animals—and humans.

Rape oil was widely used in animal

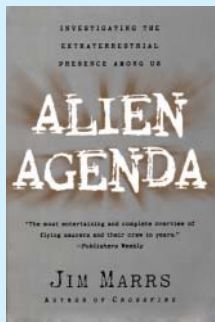

ALIEN AGENDA: Investigating The Extraterrestrial Presence Among Us

BY JIM MARRS

Jim Marrs is best known for *Crossfire: The Plot That Killed Kennedy* (1989), the book that Oliver Stone's film *JFK* was partially based on. Now Marrs attacks new mysteries and conspiracies in this extensive review of UFO history and government cover-ups. After describing his own UFO sighting near Jackson, Mississippi, in 1952, Marrs recounts his involvement with other UFO cases as a newspaper reporter, and his suspicions that the U.S. government knows much more about aliens than it will admit. He incorporates an ample amount of information from UFO books of the 1960s and 1970s—strange lights on the Moon, the ancient-

astronaut theories of Erich von Daniken, cattle mutilations, Nazi saucers at the South Pole, the contactees of the 1950s—and updates it credibly with UFO data from the 1980s and 1990s, providing a reasonable survey of abductions, secret underground UFO bases, the MJ-12 group, crop circles, remote viewing, and channeling. How can something as momentous as contact with aliens be kept secret? In an appendix, Marrs refers to the Bilderbergers and the Council on Foreign Relations as examples of how small groups of powerful individuals can withhold information and manipulate world events. The facts are mostly accurate, and the writing is crisp and journalistic.

— George Eberhart, *Ft. Worth Star-Telegram*

**SEE NEXT-TO-LAST PAGE FOR ORDERING
OR CALL TOLL-FREE: 1-877-280-2866**

feeds in England and Europe between 1986 and 1991, when it was thrown out. You may remember reading about the cows, pigs, and sheep that went blind, lost their minds, attacked people, and had to be shot.

A woman called me from Chicago to tell me that she had been in England when the “Mad Cow Disease” was at its peak. She said that she had seen a television news report which told people not to panic if they had been using rape oil in their diet and were over 65 years of age. The “experts” added that the effects of rape oil in ingestion take at least 10 years to manifest, and in all likelihood, most of these people would be dead by then anyway. Comforting!

In the reports I read, the “experts” blamed the erratic behavior on a viral disease called scrapie. However, when rape was removed from animal feed, “scrapie” disappeared.

No longer a European livestock problem, now it is ours. U.S. farmers grow rape seed, and manufacturers use its oil (Canola) in thousands of processed foods—with the blessing of government watchdog agencies, of course.

Officially, Canola oil is known as “LEAR” oil—Low Erucic Acid Rape. (Erucic acid is a solid fatty acid, a homologue of oleic acid, derived from oils of mustard seeds and rape seeds.) Industry experts love to tell how Canola was developed in Canada and that it is safe to use. (Can-ola = “Canadian oil”—get it?) They admit it was developed from the rape seed, but that through genetic engineering (i.e. irradiation), it is no longer rape seed, but Canola instead.

They love to talk about Canola’s qualities—its unsaturated structure (omega 3, 6, and 12), its wonderful digestibility, and its fatty-acid makeup. They turn us against naturally saturated oils and fats, while they come to the rescue with Canola oil. They even tell us how Asia has warmly embraced Canola due to its distinctive flavor.

Isn’t it wonderful how internationalist brokers “help” third-world peoples? Reminds me of the introduction of the microwave oven.

[*Editor’s note: That’s another very important health subject we’ve covered, in an article titled **Some Well-Hidden Hazards Of Microwave Cooking**, back in the January 2001 issue of The SPECTRUM.*]

An earthy expression from the Old West sums up the flimflam accompanying rape oil’s rebirth and promotion worldwide: “horseshit and gun smoke!” Its new name provided the perfect cover for commercial interests wanting to make billions in the

United States. The euphemism is still very much in use, but is no longer needed. Look at the ingredients lists on peanut butter labels. The peanut oil has been removed and replaced with rape oil.

[*Editor’s note: Now stop and think about that one for a minute! Going to such an extreme suggests an agenda far beyond any simple business “cost effective” step in manufacturing.*]

Chemical Warfare

Rape oil is also the source of the infamous chemical-warfare agent, mustard gas, which was banned after blistering the lungs and skin of hundreds of thousands of soldiers and civilians during WW-I. Recent French reports indicate that it was again used during the [1991] Gulf War.

Between 1950 and 1953, white mustard (rape) seed was irradiated in Sweden to increase seed production and oil content. Irradiation is the process the experts want to use to make our food “safe” to eat. Genetically engineered fruits and vegetables—which will soon have innocent things like Hepatitis-B spliced into their DNA—are another example of man’s misuse of technology and abuse of public trust by powerful interests and “head-in-the-sand” watchdog agencies. (See the article called **The Devil’s Bargain: Gene-Altered Food**, in the November/December 1995 issue of *Perceptions*.)

[*Editor’s note: Regular readers of The SPECTRUM are likewise very well aware of the pitfalls of genetically engineered or genetically modified (GE/GM) foods. And, of course, the most telling incident of all was when GE/GM giant Monsanto’s own headquarters cafeteria REFUSED to use such products!*]

Canola oil contains large amounts of isothiocyanates—cyanide-containing compounds. **Cyanide INHIBITS mitochondrial production of adenosine triphosphate (ATP), which is the energy molecule that fuels the mitochondria.** ATP energy powers the body and keeps us healthy and young!

[*Editor’s note: So in effect the Canola oil acts as a slow poisoning agent, if nothing else. Who does that suggest to you is behind this project? Hint: Who has a longstanding agenda item to eliminate we “useless eaters and consumers of natural resources”—and has the worldwide means to do so?*]

Canola Oil & Metabolism

Many substances can bind metabolic enzymes and block their activity in the body. In biochemistry, these substances

are called inhibitors.

Toxic substances in Canola and soy oils encourage the formation of molecules with covalent bonds which are normally irreversible: They CANNOT be broken by the body once they have formed.

For example, consider the pesticide malathion. It binds to the active site of the enzyme acetylcholinesterase and stops this enzyme from doing its job, which is to divide acetylcholine into choline and acetate.

Nerve Function And Organophosphates

Organophosphates are any organic compound containing phosphorus, specifically ones used as insecticides, e.g. malathion—the “harmless” pesticide spray used to kill the Med Fly and blanket every living thing in California a few years ago, and again in 1994 and 1995, and in Texas in April 1995.

Acetylcholine is critical to nerve-impulse transmission. When acetylcholinesterase is inhibited, as by pesticide residues, nerve fibers do not function normally, and muscles do not respond.

For example, think of a garage door opener: If its signal is not received, the door does not open. With one’s body, the hand or leg is ordered to move, but does not respond. Recently there has been a tremendous increase in disorders like systemic lupus, multiple sclerosis, cerebral palsy, pulmonary hypertension, neuropathy, and “myelinoma”, which is a catch-all term used by doctors for the deterioration of the myelin sheathing around the nerves. (The word ending “-oma” means “tumor”, but the condition could as easily be “myelinosis”.) It is also often called “walking legs syndrome” and causes its sufferers intense burning sensations they must walk off.

Soy and Canola oils are players in the outbreak of these disease conditions. So are the organophosphates—insecticides such as malathion, used in food production [*modern agribusiness*] in the name of efficiency.

Acetylcholinesterase inhibitors cause paralysis of the striated (skeletal) muscles and spasms of the respiratory system. That is why malathion is the pesticide of choice by experts; it kills insects by paralysis—just like rotenone from soy beans does! It inhibits the insect’s enzymes—and those of humans, too!

Agents Orange and Blue that were used in Vietnam to defoliate jungle cover are also organophosphorous compounds. The Vietnam vets and the Vietnamese people know about them firsthand. **Government**

experts who okayed their use, and chemical companies who manufactured them, have finally owned up to their toxic effects on people and the environment. Nevertheless, present-day experts in academia and government continue to bamboozle the public with stories of “safe” science and cheap food through the use of poisons.

Canola oil is also high in glycosides that cause serious problems by blocking enzyme function and depriving us of our life force—chi, qi, prana—call it what you like.

Glycosides interfere with the biochemistry of humans and animals. Their presence in rattlesnake venom inhibits muscle enzymes and causes instant immobilization of the victim.

Canola Oil, HIV, And AIDS

Soy and Canola oil glycosides also depress the immune system. They cause the white-blood-cell defense system—the T-cells—to go into a stupor and fall asleep on the job. These oils alter the bioelectric “terrain” and promote disease. Floride, immunizations, antibiotics, and bio-junk food play a similar role in immune system collapse.

An alcohol is a chemistry term for the “reactive” chemical group on an organic molecule. These “R” groups are what make organic compounds work—for good or bad! Canola alcohols and glycosides are very reactive. They are as toxic as fermented alcohols, but their effects manifest differently. The damage takes years to show up. In a future article, I will discuss the sweet proteins in soy.

When the medical “experts” check your blood for the presence of the HIV virus, they are looking at your white blood-cell “count”. If the numbers are normal, they will tell you that you do not have HIV. What they don’t see is that the T-cells are in this toxic stupor. This opportunistic condition causes life forms in the blood and lymph to metamorphose, manifest as Hepatitis, Pneumonia, and HIV, bypass the body’s immune-system defenses (the T-cells), and get a foothold. As Claude Barnard said: “The terrain is everything!”

Once inside the cells, HIV takes over the RNA and DNA. It uses the mitochondria to produce energy for its own use. Quietly it multiplies; then one day—BANG!—you wake up dying of AIDS.

AIDS & Green Monkeys

In his Earth-shaking book called *AIDS: The End Of Civilization*, Dr. William Campbell Douglass asked: “Do you really think some green monkey all of a sudden bit some guy in the ass, and presto, AIDS all over the world?”

Dr. Douglas was examining the hype that the Centers for Disease Control in Atlanta have been peddling to the public about the AIDS virus, HIV. Douglass’ book tells the “whole” story of the development of HIV at the Ft. Detrick (Maryland) military installation. His story is well documented and confirms the theme of the futuristic movie *Outbreak*.

[Editor’s note: As our readers know well, longtime SPECTRUM friend and health crusader Dr. Len Horowitz has exposed in great detail the vast historical webs of conspiracy behind AIDS and many other manufactured diseases—mostly involving the same cast of nefarious characters working in concert with the elite world controllers.]

Lorenzo’s Oil

Another film, *Lorenzo’s Oil*, offers a good example of how far off course medical science has strayed and how muddled is the scientific mind. Early on in the movie, the experts say the

PHILADELPHIA EXPERIMENT CHRONICLES BY COMMANDER X

Explores the strange case of Al Bielek (only known survivor of the Philadelphia Experiment) and the mysterious death of famed astronomer Dr. M. K. Jessup, who first broke the news about the disappearance of the warship and its subsequent teleportation into another dimension. Also looks at time travel, alternative energy, anti-gravity theories. Highly classified government/military projects exposed.

SEE NEXT-TO-LAST PAGE FOR ORDERING OR CALL TOLL-FREE: 1-877-280-2866

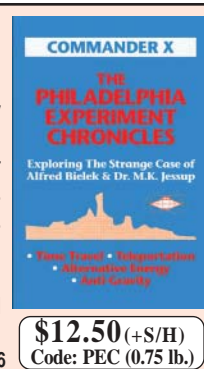

THE SMOKEY GOD AND OTHER INNER EARTH MYSTERIES

Half of the book consists of a reprint of the classic *SMOKY GODS* written by a Swedish fisherman who claims he found his way inside the Earth and had an amazing encounter with a race of super-wise giants who have lived inside the Earth since ancient times. Book also contains evidence that at least some UFOs may come from inside Earth and are piloted by a race of super-beings who have survived, largely unknown to the surface world. Includes interview with an inner Earth inhabitant from a city beneath Mt. Shasta.

SEE NEXT-TO-LAST PAGE FOR ORDERING OR CALL TOLL-FREE: 1-877-280-2866



SECRET UFO DIARY: EXPOSING THE EXISTENCE OF ALIEN SKYMEN

Shocking private memoirs of former Navy Commander involving the retrieval of UFO wreckage near our nation’s capital & how it suddenly “disappeared” from the secure government safe it was being stored in. Have aliens been coming to the Earth’s surface & experimenting with us for thousands of years?

Introduction by Commander X. 256 pages.

SEE NEXT-TO-LAST PAGE FOR ORDERING
OR CALL TOLL-FREE: 1-877-280-2866



SUBTERRANEAN WORLDS INSIDE EARTH BY TIM BECKLEY

Is the Earth hollow? Is our planet honeycombed with caverns inhabited by mysterious races? Are there civilizations of super beings living beneath the surface of the Earth? Are the residents of this subsurface world friendly, or do they have our domination in mind? Here are strange and unexplainable legions of the “Wee People”, the Dero, and long-haired Atlantean giants as encountered by cave explorers and miners trapped far beneath the Earth.

SEE NEXT-TO-LAST PAGE FOR ORDERING OR CALL TOLL-FREE: 1-877-280-2866

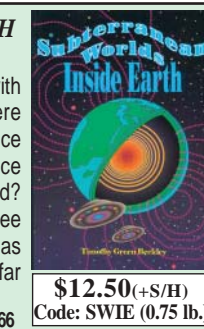

PROPHECIES OF THE PRESIDENTS: THE SPIRITUAL DESTINY OF AMERICA REVEALED BY TIM BECKLEY

The future of America? Chapters include: Origin of Great Seal of U.S. • Psychic presidents (including Lincoln, Washington, Kennedy) • Coming Polar Shift & America’s destiny • Reincarnation of Atlantis • America’s great curses • Secret Government—who’s really in control? • Space visitors watch over America • All presidents since Eisenhower said to have met with ETs on American soil.

SEE NEXT-TO-LAST PAGE FOR ORDERING
OR CALL TOLL-FREE: 1-877-280-2866

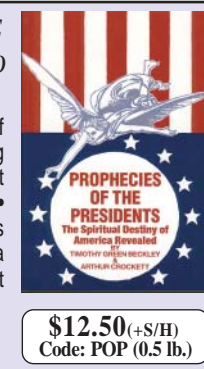

problem with the dying child is not the "math", i.e., pH. They are wrong.

Had the experts determined the pH of the saliva, urine, and blood, they would have instantly known what they were up against: That dying boy had a chronically low total-body pH—so low [meaning a highly acidic state] that his fluids were dissolving the myelin sheathing protecting his nerve fibers. This caused his nervous system to disintegrate. Does this description sound like the dozens of degenerative nerve-related disorders plaguing people today?

The boy was given Lorenzo's oil to boost energy output and act as a detoxifier of metabolic poisons. The oil shocked his body into a less-acid condition. **LORENZO'S OIL IS OLIVE OIL!** When given in large quantities, olive oil shocks the body and causes it to adjust its pH. It will also safely purge the body of gall and liver stones, thus removing the need for gall-bladder surgery. (Yucca extract and PACs must precede the "flush".)

[Editor's note: One of the reasons for again sharing this fine article with you was precisely the fact that two well-known products, that always contained olive oil as a key ingredient, have recently replaced the olive oil with Canola oil. But you can't tell that from the big labels on the front of the bottles; you have to read the fine-print ingredients list!]

Shortly after *Lorenzo's Oil* was released, my brother saw an "expert" on a TV talk-show claim that Lorenzo's oil was rape oil. This was a lie. Give rape oil to a sick person, and you will seal his or her doom.

HERE IS ANOTHER GOOD EXAMPLE OF "DISINFORMATION" IN THE PUBLIC DOMAIN. THESE FALSEHOODS SHOULD CAUSE EVERY THINKING PERSON TO QUESTION THE MOLDING OF PUBLIC OPINION BY THE

POWERFUL COMMERCIAL INTERESTS BEHIND THE SCENES.

Blood & Oils

By now it should be obvious that congested blood and lymph flow negatively affect every part of the body. Moreover, using processed foods containing Canola oil, soy oil, and chemical additives "confuses" the body and weakens the immune system.

It should come as no surprise that anyone wanting to enjoy peak health and longevity MUST take personal control of, and responsibility for, his or her health and life. There is NO other way! "Healthcare industry" is an oxymoron; it protects its own health and economic interests.

Learn to protect YOUR health and economic interests by learning how to take care of yourself. Then act on that knowledge.

* * *

POINT:

The Great Canola Debate

Spectrum Naturals Offers A Rebuttal To "Blindness, Mad Cow Disease, And Canola Oil"

As a service to both writers and readers, Perceptions offers a forum for informations all too often absent from mainstream media. We make no claims for any specific health products or therapies, but provide space to those responsibly presenting opposing views.

The following "debate" involves a spokesperson for Spectrum Naturals, a manufacturer of Canola and other oils, and John Thomas, author of Young Again! How To Reverse The Aging Process. As always, we invite our readers to think and seek the truth and, with it, greater power for themselves, recognizing that it is sometimes found only outside current scientific dogma.

Upon even the most casual consideration, Thomas' major assertions fall flat. The article, based on the author's opinions, cites no clinical, medical, or biological research references. Thomas fails to explain the basic biochemical interactions that are inferred to evolve out of the claimed actions of toxins he attributes to Canola oil. To be scientific, Thomas' claim for the ensuing biological pathologies should be tied to specific symptomology. Thomas offers no such connection.

Despite Thomas' claims, his article contains not one scientific reference, nor any cogent chemical or biochemical argument based on known laboratory testing or methods associated with brassica/napus campestris plant varieties (the botanical name of Canola) or L.E.A.R., i.e., Low Erucic Acid Rapeseed. Further, Thomas presents no scientific credentials or experience which would lend any measure of credibility to the discourse he offers in *Perceptions*.

With the above preamble in mind, please review our analysis of Thomas' claims. Spectrum's abridgment of Thomas' claims are noted below. [Editor's note: Remember that this reference is to a company called Spectrum Naturals, which is in the dietary oils business; there is NO connection at all to The SPECTRUM newsmagazine!] They can be found throughout his article, but we have condensed them to deal with claims in summary. They have been grouped here for focus. Our point-by-point response includes scientific citations and refutations for your consideration.

Thomas' Claim 1: Glaucoma

For years "experts" have been telling us that glaucoma results from fluid-pressure buildup in the eye that causes the optic nerve to deteriorate. This theory was based on an incorrect medical model: They were wrong! Causes: agglutination, waste buildup in cells, and intracellular fluids caused by consuming soy and Canola oil. Loss of vision is a known characteristic.

Spectrum's Rebuttal:

Glaucoma is caused by fluid-level abnormalities in the ocular membranes of the eye. It rarely occurs before age 40. This disease is caused by injury to the eye or a degenerative disease like uveitis. Blockage of the drainage duct adjacent to the ciliary muscles is the principle cause of humoral-fluid pressure in the eye. No scientific study links glaucoma to any lipid toxicity or diet.

Platelet aggregation, as Mr. Thomas

An article by John Thomas, published in the March/April 1996 issue of *Perceptions* magazine, makes several unsubstantiated claims connecting Canola oil with "Mad Cow Disease".



VATICAN ASSASSINS Companion CD-ROM

This is the same CD-ROM that is included with the book *VATICAN ASSASSINS* and contains 13 rare, historical, out-of-print books (over 4,000 pages!) used in the researching of that masterpiece volume.

Titles on the CD-ROM are: *The History of Romanism*, Dowling, 1845; *History of the Jesuits*, Nicolini, 1854; *Popery, Puseyism and Jesuitism*, Desancis, 1905; *The Engineer Corps of Hell*, Sherman, 1883; *Secret Instructions of the Jesuits*, Brownlee, 1857; *The Black Pope*, Cusack, 1896; *The Jesuits*, Griesinger, 1903; *The Footprints of the Jesuits*, Thompson, 1894; *The Awful Disclosures of Maria Monk*, Monk, 1835; *The Thrilling Mysteries of a Convent Revealed!* Peterson, 1835; *The Jesuit Conspiracy: The Secret Plan of the Order*, Leone, 1848; *The Crisis: Or, the Enemies*

ONLY \$15.00 (SHIPPING INCLUDED) See next-to-last page for ordering or call toll-free: 1-877-280-2866

Code: VACD (0.5 lb.)

states, is a possible cause of glaucoma. If his suggestion is true, however, Canola oil may be helpful in glaucoma since the 10% omega-3 fraction in Canola oil, as well as the 16% omega-6 fraction of fatty acids tend to reduce platelet aggregation. Thus, Canola oil would be a curative rather than causative agent of aggregation of cells. However, there is no scientific evidence that platelet aggregation is related to this eye disease.

People suffered with glaucoma long before the widespread use of Canola, rapeseed, and soy oils. To the contrary, statistics tend to indicate that the widespread use of these oils benefits health. [Ref: Dr. C. Calyman, editor, American Medical Association, *Encyclopedia Of Medicine*, Random House, NY, 1989; Shahidi, F., *Canola & Rapeseed, Production Chemistry, Nutrition And Processing Technology*, AVI Printers, 1990.]

Thomas' Claim 2:

Canola appeared out of nowhere. Rapeseed (Canola) is the most toxic of all food plants. Rapeseed, like soy, is a weed. Insects will not eat it. Oil from rapeseed is 100 times more toxic than soybean oil.

Spectrum's Rebuttal:

For more than 3,000 years, rapeseed was the preeminent culinary fat for the Indians, Western Asians (Indian subcontinent), and China. It has been cultivated in Western Europe since the 13th century and has become the most popular culinary oil due to its high oleic and mono-unsaturated fat profile. It is considered the most nutritionally balanced dietary fat. In 1985 the USDA granted GRAS (generally recognized as safe) status to the hybrid variety of rapeseed. Canola was pedigree bred (not genetically engineered) in Canada during the 1970s.

[Editor's note: Now there's a statement whose "deception coefficient" is worthy of the Bush Administration; see Al Martin's columns elsewhere in this issue of The SPECTRUM for similarly choice examples. By some liberal stretching of the definitions, it may even have been true "during the 1970s"—but, just from past eye-opening articles in our News Desk, we know that the terms *Genetically Engineered and Genetically Modified* have, through Monsanto's aggressive marketing tactics alone, been associated more with rape seeds than perhaps with any other GE/GM agricultural product pushed on farmers.]

The origins of the seed are "nigra" or

black mustard, generated to "juncea" or leaf mustard, generated to "campetris" or turnip rapeseed, and it is a cousin of kale and cabbage plants. Napus is the common variety grown in the Western world. Because Canola is susceptible to numerous types of pests which thrive in temperate climate zones, it is only grown in climates that do not experience extended periods of freezing. Canola seed plants are susceptible to flea beetles, aphids, cabbage seed-pod weevils, and all types of foliage-feeding insects which thrive in temperate climates. This plant does poorly in southern climates due to insects; geographic regions out of Kansas are not suitable. Because of their extended cold weather, western Canada and the Great Plains states are the prime areas for cultivation.

The consumption of Canola for feed or oil content presents no known toxicity in either crude or refined states. The L.E.A.R. variety has only a small percentage of erucic acid remaining in the oil (less than 0.02% to 0.01%). Erucic acid is the same substance that gives mustard its potent flavor bite. All mustards that have this potent flavor property contain some percentage of erucic acid (up to 66%). The special breeds used for Canola cooking oil contain only very small amounts. This flavor property was bred out for taste, not health considerations.

Barlow and Standby corrected the prior perception that erucic acid was damaging to humans, as the original studies were conducted on rats with flawed results. Recent laboratory research has retested this hypothesis and indicated that the 1970 findings were flawed. Unfortunately, these flawed studies continue to be cited in error. Erucic acid has not been proven harmful in humans and has been used as a medicine in others (see *Lorenzo's Oil*). [Ref: Barlow, S.M. and Standby, M.E. eds., *Nutritional Evaluation Of Long-Chain Fatty Acids In Fish Oils*, London: Academy Press, 1982; Bell, J.M., "From Rapeseed to Canola: A Brief History Of Research For Superior Meal And Edible Oil", *Poultry Science*, 61:613-618, 1982. *Canada Grains Council, Canadian Grain Industry, Statistical Handbook*, Winnipeg, Manitoba, Canada, Jan. 1988; Murray, G.A., Auld, D.L., O'Kieffe, L.E., and Thill, D.C., "Winter Rape Production Practices In Northern Idaho", *Idaho Agricultural Exposition, Station Bulletin*, 634, 1984.]

Thomas' Claim 3:

Canola is an industrial oil not fit for human consumption. Rapeseed causes

emphysema, respiratory distress, anemia, constipation, irritability, and blindness in animals.

Spectrum's Rebuttal:

Canola is not an industrial oil. Canola is and has been history's most investigated fat and feed source for humans and animals. Walnut, soybean, and flax oils, high erucic rapeseed H.E.A.R. variety, can be used industrially to make paints, plastics, cosmetics, inks, etc. Any organic hydrocarbon (meaning all vegetables) can be processed and denatured to make industrial chemicals. Extensive refining and modification of vegetable phytochemicals makes them inedible. Protein in milk can be used to make glue, the oils in orange skins are used to make explosives, the skins of various fruits emit gases that can be fatal in high concentrations. Various plant chemicals which serve humanity well as foods can be dangerous and even lethal in high concentrations. [Ref: American Heart Association, Report of Nutrition Committee, "The Value And Safety Of Diet Modification To Control Hyperlipidemia In Childhood And Adolescence" *Circulation* 58:381, 1978; Kramer, J.K.G., Saur F.D., and Pigdin, W.J. eds., *High And Low Erucic Acid Rapeseed Oils*, Toronto: Academic Press, 1983.]

Thomas' Claim 4:

Rapeseed causes "Mad Cow Disease".

Spectrum's Rebuttal:

"Mad Cow Disease" is a brain disorder (spongiform encephalopathy) caused by errant protein structures in the brain. Prions (pronounced pree-ons) are the suspected cause. Neither bacteria nor virus, these are protein structures that cause decay of synapses, nerves, and cells in the brain. The transmission of "Mad Cow Disease" occurs when the rendered animal tissue from sheep and other animals is added to cattle feed. Offal and diseased organ tissues are the suspected transmission vector, originating in sheep, with crossover into cattle and then humans. Cattle are not fed Canola oil as part of their typical diet in England. There is no proven or even suspected causative role played by Canola seed, meal, or oils in this disease. Mr. Thomas' link between Canola and "Mad Cow Disease" is a completely inaccurate affiliation of an edible oil to a serious health problem. [Ref: *Wall Street Journal*, March 26, 1996, Section A15, "EU Agrees To Ban Exports Of British Beef (Mad Cow

Disease)”; *Press Democrat*, “Mad Cow Disease” March 26, 1996.

Thomas’ Claim 5:

Rapeseed is genetically engineered.

Spectrum’s Rebuttal:

Some forms of rapeseed are genetically engineered—primarily the somatic diploid or gametic haploid cell modification. However, all new seed variants were within the same species block as far as our research shows. In other words, there is no evidence that cross-species genes were used. The rapeseed varieties are primarily used in seed varieties that have industrial uses. Canola does not fit into this category since it is an edible human oil produced under very tight controls governed by both the United States and Canadian departments of agriculture.

Editor’s note: And while those “very tight controls” looked good on paper to politicians and bureaucrats “well-oiled” by GE/GM money, as many more scientific and common-sense voices predicted, those so-called controls proved useless to prevent the contamination of adjacent fields with undesired GE/GM rape seed (and other) varieties. So it’s a big mess right now that’s kept mostly out of the press because the “expert” opinions were—as is usual where Big Money is involved—wrong. And that often quoted “scientific” baloney rests on top of the typical kind of deception quoted since the mid-1990s, to push GE/GM agriculture, such as you are about to read.]

Furthermore, Canada has a strict genetic-engineering program and closely controls the release of new plant varieties. The seed stock which generated Canola from rapeseed originated from experiments conducted in the 1970s—twenty years before genetic engineering became popular in the United States. [Ref: Chen, B.Y., Heneen, W.K., and Jonsson, R., “Re-synthesis of Brassica Napus L”, *Plant Cell Reports* 7:407-40, 1988; Chuong, P.V. and Beverdorf, W.D., Powel, A.D. and Pauls, K.P., “Somatic Transfer Of Cytoplasmic Traits In Brassica Napus L By Haploid Protoplast Fusion” *Molecular Gen. Genet.* 211:197-201, 1988.]

Thomas’ Claim 6:

Rapeseed “isothiocyanates”, cyanide-containing compounds, cyanoglycosides, and glycosides in Canola, interfere with the biochemistry of humans

and animals. Soy and Canola glycosides also depress the immune system.

Spectrum’s Rebuttal:

Most seed of any type have small amounts of cyanogenic glycosides. If ingested in concentrated amounts over a number of years, these cancer-causing agents may be detrimental to one’s health. When consumed in large quantities, however, even common apple seeds become lethal due to the organic cyanide compounds each seed contains. Rincin, processed from rice, is also a lethal refined material used as a nerve agent. However, these toxic substances do not make rice, apples, and Canola seeds lethal in their natural form. These chemicals become toxic only if synthesized using highly refined and post-refined techniques.

Super-high concentrations of these toxins cannot be found in Nature. Mustard gas is another example. There is no mustard gas in natural rapeseed, mustard, or Canola seeds. Flax seed, if harvested green or frozen before curing, has high levels of prussic acid, a form of organic cyanide. Cyanide in excess can cause illness and even death; however, the heating of seeds destroys these low-level natural agents. As seeds are expeller-pressed and heated above 120°F, isothiocyanates and other compounds are destroyed. [Ref: Erasmus, U., *Fats That Heal, Fats That Kill*, Alive Books, 1990; Erasmus, U., *Fats & Oils, The Complete Guide To Whole Wheat & Nutrition*, Alive Books, 1986.]

Thomas’ Claim 7:

Lorenzo’s oil is olive oil.

Spectrum’s Rebuttal:

Lorenzo’s oil was not olive oil. Croda, the New Jersey-based lipid-research and specialty-oil-products firm, developed a purified erucic fatty acid, the very same substance in mustard that gives the pungent bite to mustards. Erucic acid, used as a therapeutic agent, helped the little boy in the movie *Lorenzo’s Oil*, stabilizing his disease condition. Erucic acid is a 22-carbon-chain fatty acid with a single double-bond (C22:1). Olive oil has no naturally occurring erucic acid, unless it has been blended with Canola oil. Lorenzo’s oil is not olive oil. [Ref: Lavoisier, *Dictionnaire Des Huiles Vegetables*, Springer-Verlag, USA, Salunke D.K. 1996; Chavan J.K., Adsule, R.N., and Kadam, S.S., *World Oilseeds: Chemistry, Technology, And Utilization*, AVI Books, 1992.]

We trust that the foregoing scientifically substantiated rebuttal to Thomas’ unfounded claims for a connection between “Mad Cow Disease” and glaucoma clarifies the issue to your satisfaction.

— Rees Moerman

* * *

COUNTERPOINT:
The Great Canola Debate

John Thomas Responds To
Spectrum Natural’s Rebuttal

I expected the Canola cartel to go ballistic when *Perceptions* magazine published the “Blindness and Oils” chapter on Canola from my book *Young Again! How To Reverse The Aging Process*. I look for a repeat performance from them when the soy oil, soy protein, tofu scam impacts public consciousness.

Spectrum Naturals conjured up the usual establishment tar and feathers: “no scientific proof, lack of credentials, divergence from known and recognized scientific community” and other mewings designed to belittle me, degrade *Perceptions*, and blur public consciousness about **the energy nature of the substances we call food and water. Spectrum does not understand that all substances have a racemetric energy footprint and electrical signature that manifests itself as a “measurable” right-or left-spinning energy field.**

When food enters the body, it imposes and transfers its vibratory signature to the body’s bioelectric energy fields. Therefore, food and water either increase or diminish health and the body’s energy spin, as reflected in our aura. The effect is best described as a bioelectric energy shift. This shift is not based on carbohydrates, fats, and proteins, and is not understood by conventional science, which knows disease and aging only by their symptoms.

Food and water influence the tissues and cells through the homeopathic principles of resonance and transference, which describe subtle energy changes in the body when substances are introduced into the system. Canola and soy upset the body subtle-energy fields because they are powerful, deep, and rapid left-spinning energy substances that are toxic and, therefore, should NOT be ingested.

I suggest everyone learn to use a pendulum, a vibration chain, and aurameter so they can confirm for themselves that Canola and soy are bad news. I highly recommend everyone read the article “Soy Products For Dairy

Product? Not So Fast..." in the September 1995 issue of *Health Freedom News* and learn of the deleterious effects of soy oil and soy protein on living systems. Then let's see what Spectrum has to say in response to this very well done article that backs up and confirms what I had to say in my chapter on soy: "Bald Heads And Oil".

Once people understand the energy nature of food as relates to aging and rejuvenation, they will discover to their horror that Canola and soy are not only out of place in their diets, but actually accelerate the breakdown of the body's connective tissues and nerve fibers.

These "experts" who have been telling us fairy tales about the wonders of Canola are the same nice folks who vaunted oleo and soy margarines and orchestrated the condemnation of butter, coconut oil, and lard.

Is it any surprise? Last year's [1995] haul on "industrial" food oils—like Canola and soy—was in the range of \$12,000,000,000 (BILLION)! As the consumption of these oils increases, people's health slowly deteriorates and the old-age homes and cemeteries fill. Scientific madmen seem to forget that the human body works synergistically and that their snake oil has multiple fangs when turned loose in bodies already stressed from environmental and chemical toxicities.

The toxic effects of Canola and soy take years to manifest.

[Editor's note: What could be more convenient to the New World Gang's depopulation agenda than a subtle-acting time-delay poison to make it difficult to trace blame—a much better plan than the tobacco industry's longtime scam.]

Laboratory test tubes, studies, and industry experts cannot be counted on to give us the truth. Wasn't it "experts" who gave us Agent Orange, DDT, malathion, thalidomide, Gulf War Syndrome, aspartame (NutraSweet), MSG (monosodium glutamate), Swine Flu shots, fluoridated water and toothpaste, and presently, live Hepatitis-B vaccines for helpless children under two years of age?

How about conditions like Type-1 diabetes, hearing loss, and death in children from mutant DPT and polio vaccinations the "experts" are rabidly pushing at us? What about the thousands of "safe" drugs the pharmaceutical and medical folks peddle—all with known, toxic contraindications for the liver (our most vital organ)?!

Perceptions readers should not be

surprised to learn that the international food cartels peddle energy-toxic, industrial "food" oils like Canola and soy to an unsuspecting and ignorant public. The experts don't have a clue about disease prevention and consider aging reversal to be ludicrous. Spectrum's experts quote chapter and verse to support their position, but it matters not. Their response suggests that behind the smoke screen is a powder keg of information they hope the public will never learn. *[Just like finally came out in the tobacco industry scam.]*

Young Again! How To Reverse The Aging Process was not written as a scientific work, but as a common-sense guide to help people understand why they prematurely age and die.

If your readers want to keep their health or get back what they have lost, they must learn to ignore the advice of the experts and do exactly the opposite of what the masses are being brainwashed to do and think.

Canola and soy are serious players in degenerative aging and disease. At best, they confuse body energy patterns. At worst, they become the straw that breaks the proverbial camel's back—or precipitate things like "Mad Cow Disease", glaucoma, and a thousand other "degenerative" conditions that keep the cattle lines in the clinics full and profitable.

Lastly, cunning marketing propaganda by the international food cartels has Americans foolishly believing in the widespread historical use of Canola just

as they did with their fairy tales about bigtime soy use in Asia and how healthy Asians are as a result of a dietary intake of soy.

The TRUTH of the matter is that we produce 144 billion pounds of WASTE soy protein a year. Cartel propaganda is behind the massive push for consumption of soy products (tofu, soy milk, and baby formulas) over conventional protein and fat sources. Soy and Canola are in almost all processed foods. We dump the balance on the Asians.

Edgar Cayce advised against the use of soy and rape (Canola) oils. Skilled doctors of Chinese medicine will not use soy because it interferes with subtle-energy patterns in the body. Canola is 1000 times more toxic than soy.

I suggest your readers read *Young Again!* cover to cover before they find their health in serious jeopardy from following "expert advice" and ingesting toxic-food substances. Vision loss, nerve degeneration, connective tissue breakdown, and balding are just a few of the problems they may avoid. For sure, they will learn how to live long and healthy lives.

— John Thomas

P.S. On my desk is a fax about a test-lab finding that Canola oil produces sterility in rabbits. Perhaps this is behind the plummeting sperm counts in young U.S. males? Canola oil is in almost every processed food on the grocery shelves. Scary! △



“. . . sodium phosphate, di-glycerides, BHT. Warning: The Surgeon General has determined that eating is dangerous to your health.”

Bushonomics And The Downfall Of America

Editor's note: There is no arguing with the point that, if you want to size-up what is happening to the United States in very concrete terms, then examine the condition of the financial arenas. No one does this better than Al Martin, whose savvy reading of the financial playing fields is like the way some of the best coaches explain the fine points of a football game.

The problem is, this isn't a game—though too many asleep Americans take it as such. And thanks to Al's courageous spelling out of the impending dire consequences, perhaps more people will awaken to reverse the writing on the wall. After all, a lot can be accomplished by the wolves in the henhouse when the guard dogs are bought and farmers sound asleep.

Remember that old story about the frogs being boiled in the pot of water? So long as the temperature goes up slowly enough, the frogs remain blissfully unaware of their predicament until it's too late. Sound familiar?

But all is not in a downhill slide, as Al so optimistically points out: "The American Psychiatric Association noted that anti-depressant sales (Prozac, Zanax, etc.) are at record highs. They have now increased 40% since the election of George Bush Jr." How's that for an omen to reflect our subconscious knowing of what's really going on?!

For those newer readers who may not be familiar with this crusader, according to his own biographical statement (at his AlMartinRaw.com Internet website), Al is America's foremost whistleblower on government fraud and corruption. A retired U.S. Navy Lt. Commander and former officer in the Office of Naval Intelligence, he has testified before Congress (the Kerry Committee and the Alexander Committee) regarding Iran-Contra. Al Martin is the author of the revealing and witty exposé titled The Conspirators: Secrets Of An Iran-Contra Insider (© 2001, National Liberty Press; order from Wisdom Books & Press: see information nearby).

AL MARTIN

Want Your Civil Liberties And Rights Back? Move To U.S.-Occupied Iraq
(4/20/03)

According to the latest reports, the benefits that Iraqi citizens will now enjoy under a U.S.-supported regime (they're not calling it U.S. occupation) will be much better than the disenfranchised naïve American flag-wavers.

General Brooks, a spokesman for CENTCOM Command, made a pronouncement reiterating the expanded *First* and *Second Amendment* privileges that Iraqi citizens will have. The would-be Iraqi leaders being groomed for the coalition they're trying to form were being interviewed and told about all the new benefits they're going to have.

A Shiite mullah with a turban on his head heard this announcement and he says: "If that's the case, I can't wait to be occupied." But what struck me funny about it is that Iraqi citizens will now have (at U.S. taxpayers' expense) universal free healthcare coverage, universal education up to university level, and they will be entitled to financial aid for the purchases of food, utilities such as water and electricity will be subsidized, gasoline for cars, and so on will remain at 13¢ a gallon. How can you beat that?

Iraqi citizens understand that it is a coalition of widely disparate people who the United States has to put together in order to rule Iraq under at least the guise of an Iraqi government. He said that there will be protests against us in Iraq, but Iraqi citizens should know that they will have all the rights of civil disobedience and they will be able to protest. Also, Iraqi citizens will have the absolute right to keep and bear their own firearms, unfettered by the Iraqi government.

Then, after hearing all of this, I thought to myself: There are 70 million Americans who no longer have health insurance or can no longer afford their medications because medical costs are now rising by 14% a year under the Bush Administration, because the Bush

Regime will do nothing to limit costs insofar as the pharmaceutical industry is the third richest source of money for Republicans.

Tuition costs at major universities are now rising by 10% a year under the Bush Administration. At the same time, the Bush Regime is cutting back federal student aid and grants and loans.

If you're one of the 70 million Americans who doesn't have healthcare coverage, or can't afford prescription drugs, and you can't afford to send your kids to college because you've been wiped out and your 401K account is now a 201K account under the scourge of Bushonomics, and if you're concerned about your civil rights and liberties (as the representative from the Constitutional Law Center points out), Iraqi citizens will now have greater *First, Second, and Fourth Amendment* privileges than do the citizens of the United States in the post-U.S.A. *Patriot Act* world.

As General Brooks said himself, the new U.S.-backed administration in Iraq will do away with the national identity card in Iraq. At the very same time, Senator Orrin Hatch says that we see smooth sailing for the *National Identity Card Act* in this session. So while national identity cards are being done away with in Iraq, U.S. citizens will be compelled to carry them. Patriots would love to move to Iraq now.

The Constitutional Law Center's spokesman further pointed out that the State Department is forming restrictions because they're afraid that U.S. citizens who have been wiped out by Bushonomics, and are frightened of the limitation of their civil rights and liberties which have come under the Bush Regime, will start expatriating themselves to Iraq.

Subsidized by U.S. taxpayers, we are exporting the gospel of corporate socialism to U.S.-occupied territories. But at the same time we're giving the Iraqi people greater civil rights and liberties than the American people now enjoy. And that's the great irony.

Bush says that we are going to export to Iraq an absolutely free and unfettered democratic state—which is precisely the opposite agenda of what the Bush Regime is doing domestically.

Even the *Wall Street Journal* is writing about the new liberal gun policies in Iraq—much more liberal than in the United States. This is from an April 16 story by Dan Morse: “Surrounded by warehouses holding candy, yarn, tea, and shaving cream, Army Capt. Paul Stanton listens to five import merchants explain in imperfect English that they NEED the seven assault rifles his troops have found here to fend off looters. ‘You’re a businessman right? I’m going to leave you with four.’ Salam Bayram, one of the importers, counters that even seven aren’t enough. ‘Ok, here’s the deal: I’ll let you keep all seven, but we’re going to record all the serial numbers; we’re going to come by daily, and if the guns aren’t here, we’ll detain everyone.’”

Imagine this conversation in the U.S. of A.—where even one assault rifle is illegal: “But officer, I need seven assault rifles.”

Iraq is now the new Land of Milk and Honey, gratis of the U.S. Taxpayers. Or maybe it’s just the Land of Bilk and Money.

And then there’s Ahmed Chalabi, the U.S. quisling choice to head the government in post-war Iraq, who is strongly supported by the Department of Defense and the CIA, despite State Department opposition. And that is so common during Bush Regimes. DoD and CIA always support an old Bush Cabalist like Chalabi, and the State Department says: “Watch out for this guy.” After all, this is a guy who hasn’t been in Iraq in more than 40 years. Although he was well known and respected in Iraq at one time, now nobody in Iraq remembers who he is anymore. The median age in Iraq is 29 years and this Chalabi hasn’t been in Iraq since 1958—i.e., since Edsels were manufactured.

Chalabi is wanted by the kingdom of Jordan for banking fraud. He was involved with Bushonian-controlled companies during the Iran-Contra period, all the way to the early 1990s before Clinton came into office.

Chalabi cofounded Petra Bank in Jordan in 1978, which collapsed in 1989 after which he fled the country. In absentia, Chalabi was then tried and convicted of embezzlement, theft, and fraud. Chalabi was afraid the Clinton Administration might extradite him to Jordan, which they did consider doing.

A lot of Jordanian banks got scammed during these Bushonian Cabalist banking scams. Chalabi was a principal partner in the Blackstone investment group, as were Frank Carlucci and Pete

Peterson and Dick Armitage.

Chalabi also became an associate partner with the Kissinger group in those transactions with Ghaith Pharoan and the Bush Family’s Pilgrim Investment Trust, which committed all sorts of fraud in Bahrain.

With those kinds of credentials, you could run a country. These are the perfect credentials to run a Bushonian Regime in Iraq. Chalabi is an old Bushonian Cabalist and Republican Scammer.

Al Jazeera did a poll in Iraq, and the Iraqi people definitely don’t want this guy in the leadership. They’re frightened of him. Along with the Bush Family, he’s defrauded a lot of people in the Middle East.

Meanwhile *Bloomberg News* stated that they would stand up to White House Bushonian pressure. They have been running a crawl tape on Chalabi every day. It says: “Chalabi, wanted in Jordan for bank fraud...” The White House has pressured them every day, but a spokesman said that, though CNN has knuckled under pressure, Bloomberg will keep reminding their viewers who this Chalabi is.

Evidently Mayor Bloomberg even wrote a letter to the King of Jordan asking him why Jordan isn’t pressing the extradition warrant on Chalabi it had filed with the Department of Justice. Why did they suddenly withdraw several months ago? Could it have anything to do with Jordanian “aid”?

The Jordanian government withdrew its extradition filings at the exact same time that Bush was recommending an increase of about \$143 million in Jordanian aid. As usual the American taxpayers continue to pay for the Bushonian cover-up.

This isn’t the Bushonian Cabal using the fruits of its previous frauds to maintain a cover-up. It is again the American people in their capacity as taxpayers who are forced to maintain a cover-up of those who are now in control of the government.

Even though a CNN poll said that 61% of American citizens now say that all tax cuts should be delayed, Bush keeps pushing it and pushing it.

If the \$726 billion *Tax Relief Bill* were to pass intact, including the elimination of the double taxation of dividends as well as all of Bush’s tax relief for the Republican Rich, the top 1% of the nation, which now controls 66.3% of all the private wealth of the country (78% of said people being Republicans), would in 12 months increase to 67.5% control.

In fact, the Bush Family would personally profit by at least \$14 million. And that’s probably a low figure. As the EPI pointed out in the past, so much of the Bush Family wealth is held through a network of secret and complex shadowy offshore trusts.

American citizens not only pay for their own narrow-mindedness, the American people pay to maintain the Bushonian Cover-up.

Now to all those Old Flag-Wavers: watch those taxes going up to pay for the Iraqi Occupation.

And to those Old Farts, especially those who complain about spending \$500 per month on their prescription medication: Hey, move to Iraq!

Don’t forget the vets. Even the VA medical benefits have now been reduced by the Bush Regime. The prescription charges have been increased. First it was \$3, then it went to \$7 and \$10, and now it’s going up to \$20.

The reason why they’re pushing Zolofit all the time, and Larry Kudlow talks about it, is because it reduces your willpower. As Bill Wolman said to Larry: I know why you want everyone to take Zolofit; it’s because after they’ve all lost their money under Bushonomics, they take Zolofit and you tell them to buy more stock, and they do.

You may have heard about the \$680 million sole-source non-compete contract that Bechtel got to rebuild Iraq and the \$500 million non-compete contract that CSC/Dyncorp got for the police and prisons and judiciary system in Iraq. Bushonian minions have successfully used the line that Halliburton, Bechtel, etc. are all public corporations, and if they can be helped through Bushonian largesse, then that helps all other shareholders as well.

The Untold History Of America



by Ray Bilger

This book shatters the image that has traditionally been portrayed as American History, by exposing the high-level corruption that passes for business-as-usual in the Halls of Congress, the White House, and throughout our entire Judicial System.

Special emphasis is placed throughout the book on the original Native inhabitants of America. They lived for thousands of years on this continent in complete harmony and balance with the Earth. With their help we may yet be able to turn things around so that our tomorrows will be something we will all feel honored to pass on to the children who are our future generations.

242 pages \$10 (+S/H)
Code: UHA (1.0 lb.)

SEE NEXT-TO-LAST PAGE FOR ORDERING
OR CALL TOLL-FREE: 1-877-280-2866

Just compare American society and the new Iraqi society (at American taxpayers' expense). American people should be moving to Iraq because of all the freebies we're giving them.

A lot of the right-wingers are up in arms over this. They say we should be turning Iraq into a capitalist state like the United States, but we're turning Iraq into a social welfare state at the expense of the American taxpayers.

So now all those Americans who have seen their 401K accounts turn into 201K accounts under the scourge of Bushonomics, and all those who have lost their jobs, their pensions, their healthcare, since the election of Junior, should move to Iraq. There's free healthcare. There's free education. Subsidized everything.

Will they be on the dole forever? Of course they will. Once they get used to the Yellow Brick Road of U.S. taxpayers' dollars, you'll never wean them off of it.

The Religious Right like Jerry Fallwell and Pat Robertson are always harping on the idea that the United States is supposed to be spreading the gospel of capitalism. But what we're creating in Iraq is a socialist welfare state funded by U.S. taxpayers.

This is an issue that really gets people upset, this idea of U.S. taxpayer largesse in rebuilding Iraq, when the Bushonian Regime opposes universal healthcare, universal education, etc., in the United States. Yet U.S. taxpayers are going to pay for it in Iraq.

It's as if the Great Satan is building a Yellow Brick Road for Iraqis. But don't follow the Yellow Brick Road or you'll end up with a 201K plan in America. This is directly counter to the Bushonian Regime's pretended philosophy that capitalism and free enterprise are the rules of the game.

You have to remember that there are now millions of those people in this country—millions who have had their jobs, pensions, and healthcare wiped out. This is a big issue, particularly when the Iraqi people are provided with programs which the Bush Administration opposes here in the United States.

The irony is once again deafening. Under a Bushonian Regime, you pay for it again and again and again. It's a never-ending payment scheme for the U.S. taxpayers.

That's a definition of Bushonomics: It's a Never-Ending Payment Scheme.

Even the NRA people are upset now, especially after seeing the pictures of U.S. soldiers handing out AK47s to the newly defeated Iraqis, when the AK47 is considered an assault weapon and is banned in the United States.

As General Brooks said, private Iraqi citizens will have the right to keep and bear arms—including fully automatic weapons

as well as light-armored-vehicle assault weapons. The conclusion is obvious.

Disenfranchised, disarmed Americans should immediately move to Iraq to enjoy the rights, liberties, and financial largesse which the rest of the flag-waving U.S. citizens are stupid enough to pay for.

Now you too can enjoy the new rights and liberties of the Iraqi people (which U.S. citizens have lost or will lose), as well as U.S. taxpayer-funded largesse.

Just move to U.S.-occupied Iraq. Before the rush starts.

**FLASH UPDATE:
U.S. Government
Hires Former Soviet Spies
(4/22/03)**

Former KGB counterintelligence chief, General Oleg Kalugin, confirms U.S. agency relationship with former KGB chiefs General Yevgeny Primakov and General Aleksandr V. Karpov.

Recently interviewed on the Spy Cruise (San Diego to Hawaii, March 27 to April 9), Kalugin, a Fox News commentator, stated that DARPA's Office of Information Awareness has hired both Primakov and Karpov as consultants and "advisors".

The Office of Information Awareness is headed by convicted Iran-Contra felon Vice Admiral John Poindexter.

In essence, a convicted felon (Poindexter) is hiring former Soviet spies (Primakov and Karpov) to help the Bush Administration spy on U.S. citizens.

[Editor's note: Some readers will remember the first installment of this eye-opening story, Al's 3/17/03 column on page 90 of the May 2003 issue of The SPECTRUM. That story must have really stepped on some big toes because the Internet was abuzz for awhile with disparaging accusations thrown at Al, which he explains further on in this story.]

The Office of Information Awareness has received great notoriety with its bizarre logo of a floating pyramid in space with the all-seeing eye in the capstone, flashing a searchlight onto the planet Earth.

(Why go to the lodge when you can just go to the Office of Information Awareness?)

Since it was first unveiled, however, the office has deleted its occult logo and its ponderous Masonic symbology to a much more straightforward letterhead design, which now simply says "IAO".

Another participant in the Spy Cruise, FBI counter-intelligence expert David Major admitted that Poindexter was his boss. When asked if he wasn't concerned, Major just shrugged and said that he'd have to see their (the Soviets') "backgrounds" before he could make a comment.

Evidently American spymasters have

great respect for the KGB and they want to learn all they can, so they can further their agenda of internal passports for U.S. citizens in the United States.

The British MI-5 is also aware of these "new hires" and is monitoring the situation with some alarm.

AlMartinRaw.com had previously reported that Primakov and Karpov were hired by the Department of Homeland Security, but this was incorrect.

When the Bush Administration found out that they couldn't deny this new "hiring" of Primakov and Karpov, to misdirect everyone they put out the word that these two former Soviet spies had a relationship with the Department of Homeland Security, which they don't.

In this way, when the media called (and they were constantly pestered), the Department of Homeland Security could legitimately say that the former KGB chiefs don't have a relationship with them. And it's true—Primakov and Karpov are working for Poindexter in the Office of Information Awareness.

[Editor's note: So the point of Al's original story remains quite valid (and perhaps just a bit scary), and in fact takes on even more seriousness once we see the extent of deception the Bush Administration used to try to obscure what was going on!]

**Bush Cabal's
World Domination Tour Continues;
Prozac Nation Still Sleeping
(4/28/03)**

Bushonian Regimes have traditionally used the office of the Vice President to hide mischief making. Think of the Vice President's Task Force on Drugs in 1983, formed in Miami with George Bush Sr. as its head, which acted in an illicit capacity to ensure that CIA-authorized Iran-Contra-related narcotics shipments were not inadvertently stopped.

This tradition continues to this day. George Bush Sr. himself as Vice President was in charge of Iran-Contra operations to maintain "deniability" of then President Ronald Reagan. This is the same game that Bush and Cheney play today.

Put Cheney in charge of everything that's illegal to maintain deniability for the President. What has changed? Not much. The Republican tradition of Vice Presidents taking the fall goes back to the forgettable Spiro Agnew—or at least the Republicans hope we forgot.

Meanwhile, in an important ruling, the Fourth Circuit Court of Appeals has allowed the lawsuit filed jointly by Sierra Club and Judicial Watch against Vice President Richard Cheney, in his capacity as chairman of the Energy Task Force, to proceed despite

heavy pressure against the Court from the Department of Justice.

Larry Klayman of Judicial Watch reiterated that he intends to get to the bottom of the consultations that were held in secret between U.S. oil companies and the Vice President regarding oil pricing before the war on Iraq. Klayman went on to say that this was a blatant example of Bushonian Cabalism.

The Department of Justice responded through their spokesperson, Barbara Comstock, that DoJ will “vigorously” appeal this most recent ruling and will fight “obviously liberal-influenced” courts that would allow private lawsuits to proceed that would attempt to dictate U.S. policy.

The inference is that if the Bush Administration loses on this issue before the Supreme Court, it will simply invoke their newly found national security powers and override the court’s decision. They steadfastly will not submit these materials to the court that the Sierra Club and Judicial Watch have requested, namely the so-called secret minutes of the meetings that Cheney had with various CEOs of various oil companies.

In a related matter, the General Accounting Office has stated that it too has launched an investigation into the Vice President’s affairs and his contacts with U.S. oil companies vis-à-vis the awarding of non-competitive bids under the Rebuilding of Iraq program.

As the GAO points out, the Vice President simply ignored the agreement previously made with the British and Australians and other allies who actually committed troops to the Iraqi Adventure. The Vice President was required by the agreement, which the Bushonian Regime agreed to, that these contracts would be open to British and others of our allies. The Vice President has refused to do so.

Also the GAO is concerned that the Vice President is awarding these non-competitive contracts on “a political point system”. The GAO will challenge the non-competitive status and how it was done without congressional approval, which should have been required, or so the GAO seems to believe.

They said they have support in this action from the Republican-controlled CBO (Congressional Budget Office). The inference is that the Republicans have consistently chided the GAO, but now they have the support of the Republican-controlled CBO, which also supports them in this action. They are alleging that the Vice President gave out these contracts on a political point system wherein the first preferences are given to U.S. companies which have donated the most money to the Republican Party or its interest groups.

The GAO spokesman also reiterated the comments of Larry Klayman that this is the worst case of Bushonian Cabalism yet seen.

In other news, the UN Office of Hans Blix is also upset at the Bush Administration because they’ve stated that there is no envisioned role for UN inspectors in Iraq.

UN Chief Kofi Annan wants to send a team back and so do the French, Russians, and Germans—as a condition to financially supporting the rebuilding of Iraq. The Bush Administration however wants them to sit out. In response to this, the UN announced, through the office of Hans Blix and Kofi Annan, that the Bush Administration is dangerous and they are sustained by the creation of a “web of lies unheralded in human history”.

The UN complained about it and they had documentation how the Bush Administration did it. They formally charged the Bush Regime with forging documents with intimidating and bribing witnesses to give statements in an effort to discredit UN arms inspectors in Iraq pursuant to the Bush Administration’s “need” to have a war with Iraq. They didn’t elaborate about what they meant by the word “need”—but you can probably read between the lines: in order to divert the public’s attention from what the scourge of Bushonomics is doing.

The Bush Administration is tight-lipped about it. MSNBC ran the story by Alex Witt and they made some terse comments. She was shuffling the papers on her desk and then some guy from off-camera yells (you can’t see him, but you hear his voice): “We’re not supposed to run that story.” And she turned around in her chair and looked in the direction of the voice, and then she starts shuffling her papers again, and stops reading the story. Fox News wouldn’t run it. The UN put it out to everyone, but very few people ran it. **But I like Annan’s comments about the Bush Administration in which he called them a dangerous gaggle of right-wingers maintained by a web of deceit, unheralded in human history, who are hell bent on world domination.**

The Russians already knew that the Bush Regime was sabotaging UN weapons inspectors in Iraq, and yet the Russian government came out with a statement feigning surprise, dismay, and even shock at the Bush Administration’s activities.

The Russians, French, and Germans see this as a real coup because it’s played up very well in the rest of the world, outside of the United States. **Chirac and Schroeder issued a joint statement stating that it is their belief that the Bush Administration is the single greatest danger to world peace.**

And now, with the UN report to back them up, it’s obvious how the Bush Administration has consistently acted to

sabotage the UN inspections through a web of lies, forged documents, and intimidation.

You may have heard that the U.S. Army found \$600 million in U.S. hundred dollar bills behind the wall of one of Saddam’s palaces. They showed this money being lifted out by whole lines of forklifts, pallet after pallet of freshly wrapped notes. They’re wrapped in the hermetically sealed wraps with the yellow bands, which is exactly the way they come from the Federal Reserve. However, Secretary of the Treasury Snow issued a release saying that they are nearly 100% certain that the notes are counterfeit.

Of course, coming out of the Iraqi regime, the Treasury agents believe that the Iranians gave the Iraqis the money, or the Iraqis bought the money from the Iranians because the Iranians were the only ones with intaglio presses.

This goes back to the Super Counterfeit Bills story from the early 1980s. But what everyone has forgotten now, of course, is that there was a special Army operation in 1986 (and this was widely publicized at the time) wherein a special elite Army unit

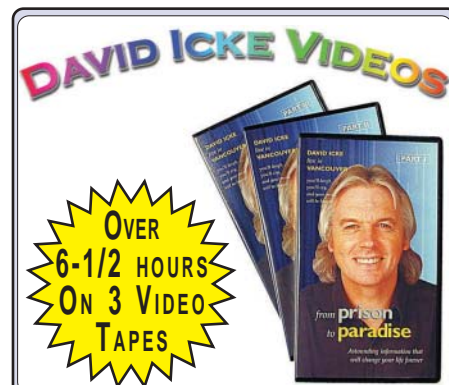

See and hear David Icke at the top of his form as he presents six-and-a-half hours of incredible information before a sellout audience of 1200 at the Vogue Theatre in Vancouver, British Columbia, Canada.

You will laugh, you may cry, and you will be on the edge of your seat as the fantastic story of true human history, and WHO really controls the world today, unfolds in Icke’s unique style, aided by video footage and hundreds of illustrations.

This is the presentation that the Illuminati (the forces of global control) tried so hard to stop—media interviews were cancelled; immigration officials turned up at the theatre to question his right to speak; pressure was applied on the venue to cancel the event itself; and pies were even thrown at David at a book signing by a rent-a-mob who ludicrously and outrageously sought to dub him a “racist”.

But nothing could silence him or break his spirit—and here you will see the result.

GET THIS 3-VIDEO SET (6-1/2 HOURS) FOR \$59.95 (+S/H)
Code: PTP (1.75 lb.)
SEE NEXT-TO-LAST PAGE FOR ORDERING
OR CALL TOLL-FREE: 1-877-280-2866

comprised of retrained (but not refried) Treasury agents secreted themselves into Iran and destroyed the Iranian intaglio presses and plates. Then the Reagan-Bush regime pressured the Government of Italy so that no more presses were sold. The Iranians haven't had the ability to produce counterfeit notes in many years, yet the Treasury department states that these notes are all the new series.

The upshot is that everybody is laughing about it. People say: "You wait and see. In a couple weeks, when these notes finally get back to the United States, the Treasury will immediately declare them to be counterfeit, and they will issue a statement saying that the notes have been destroyed." In fact, the money is genuine.

And that's how the Bushonian Cabal will get \$600 million in "extra" cash to spend.

When they showed the money, most people wouldn't understand that it's very hard to duplicate the original Federal Reserve wrappers. The notes were also block-sealed in plastic. You could tell by looking at it that this money came directly from the Federal Reserve. Not only was it block-packed, but the stacks of notes were alternated reverse, obverse, reverse, obverse. It's exactly the way they came out of the Treasury.

It should be remembered that three-quarters of all U.S. hundred dollar bills printed are in circulation outside of the United States. Only 25% of \$100 banknotes are in the United States. The Russian Government is the largest individual purchaser of the U.S. \$100 bill.

So here's a prediction: The bank notes found in Iraq will be declared counterfeit.

In other news, first quarter profit expectations of the major pharmaceutical companies, like Merck, Pfizer, et al, were 60% to 80% above original estimates. Even the individual companies all put out statements stating that it was due to the continuing surge in the sale of anti-depressants.

Coincidentally the American Psychiatric Association noted that anti-depressant sales (Prozac, Zanax, etc.) are at record highs. They have now increased 40% since the election of George Bush Jr.

The APA is a very liberal organization, completely opposite of the AMA. That's why they never amalgamated with them—because of their political differences.

The APA reminded everyone about the first-quarter profits due to the record sales of anti-depressants as the American people continued to feel the adverse effects of Bushonomics. **The spokesman for the American Psychiatric Association also stated that Bushonomics is the greatest threat to the mental health of the American**

citizens since the Great Depression.

And the Bush White House's response to the American Psychiatric Association's report? They will try to speed up the development and increase the testing on the program of the Valium Gas/Prozac Water.

[Editor's note: See Al's column in the December 2002 issue of The SPECTRUM for details about this outrageous tactic against the American people.]

It makes sense because not only is it an instrument of control, but the Bush Administration understands the great mental stress that's being created by Bushonomics and they need a way to counter it.

It also brings to mind the Gallup poll, regarding the contention of Malthus and the longevity of political parties. Malthus pointed out that in all democratic societies since the ancient Greeks (for the last 3,500 years), all political parties whose members exceeded the median age of the underlying population were extinct 50 years later. In other words, they had disappeared as the gap continued to grow between the median age of party members and the median age of the population.

In this context, in round numbers, the median age of the U.S. population is currently 36.5 years, and the median age of Republican Party members is 43.5 years. In other words, this gap has been growing and continues to grow. This is a record gap. As the *Rukeyser Report* pointed out, this does not bode well for the Republican Party.

The Republic Party did try to attract young people in the 1980s, but after the Reagan-Bush effort in the 1980s, they gave up. When the 18-24-year-old Republican vote peaked in 1986 at 24.9% of the population, I was surprised. 87.9% of all 18-24 voters were Republican, almost 90%. Today that fraction has dropped to 30% and young people have frankly abandoned the Republican Party in droves.

Could it be the End of the Republic Party (As We Know It)?

They'll just have to recruit within their families to keep the thing going. Or they can change the name back to Whigs.

* * *

And here's an update to the Flash Update of the Oleg Kalugin story (U.S. Government Hires Former Soviet Spies).

Fox News commentator and former KGB General Kalugin left his Hotel Pierre digs in New York rather abruptly after my story was posted on my *AlMartinRaw.com* website and he immediately checked in under an assumed name in a Washington DC hotel. (Note to indolent reporters: It is a certainty that the good general is staying in a hotel where Fox maintains a corporate charge

account. Although this may be the age of Corporate Journalism, good old-fashioned political investigative reporting is still alive and well at *AlMartinRaw.com*.)

It should be noted that Kalugin is one of the savviest of the KGB generals. Like a chess grandmaster, he doesn't say hello until he thinks about it first.

So here's the mea culpa: *AlMartinRaw.com* got snookered by Bushonian disinformation too, but we'll correct any errors as quickly as possible.

* * *

As a further note on the market commentary we present on this site, we called the market rally last week precisely when the SPX went to 920 and that's what we said it would move to, before it backed off. The predictions in the equities and the commodities were correct, right to the dollar.

We have to tell you about how much money you could have made. Note: Please feel free to pass this information on to your sophisticated trader friends and acquaintances so they can benefit as well. And subscribe as well.

Even Gore Vidal talks about the United States as the United States of Amnesia. And he is known to have said that he found my book *The Conspirators: Secrets Of An Iran-Contra Insider* to be "very revealing".

In more exciting news, the Highway Safety Administration announced that traffic fatalities are at a 13-year high, even with a reduced speed limit. The funny thing is that they also mentioned the growing depression of the American people. People are so depressed that they're driving wildly, like they don't care anymore.

The nation's murder and suicide rates are also at 15-year highs. All-time use of antidepressants is at an all-time high.

Psychology Today magazine, in a cover story on the new *Prozac Nation* movie, reports that almost 30 million Americans are taking Prozac—that's just Prozac and not counting other antidepressants. Alcohol consumption is at its highest since 1939. The person reporting these statistics just threw up his hands in the air and said: "The nation's falling apart!"

The reason I found this noteworthy is because this is the collateral damage (and consequences) of Bushonomics. We saw the same thing in the era from 1989 to 1991, when the Great Credit Bubble created by Bushonomics-I unraveled. We saw the same increase in highway deaths and in the murder and suicide rates, and the increase in the use of liquor and drugs.

We are, after all, a confused and depressed people because of Bushonomics.

Meanwhile the Bush Cabal's World Domination Tour continues. George Bush

says Iraq yesterday, Syria tomorrow, and North Korea next month.

So what are we going to do about it?

The Scourge Of Bushonomics Explained—Part 1 (5/5/03)

In a recent *Wall Street Journal* / NBC opinion poll, only 18% of the people claim they actually understand what a budget deficit is. And out of all the respondents, only 6% understood the deleterious effects that ever-expanding budget deficits have on economic growth. (When their check bounces and they get charged twenty bucks at the bank, these people probably ask: "Hey, why am I being penalized here? This is just a budget deficit.")

Now the Bushonian Regime is encouraging American business and industry to borrow from future revenues, and there is now a record number of companies selling on these delayed credit deals. You buy something for zero down, zero interest, no payments for a year for consumer purchases like washing machines, TVs, and cars. **And this is all done to maintain the phony consumption numbers.** Because of this I have decided to explain once and for all the meaning of Bushonomics and the scourge it represents to the American Economy.

This "borrowing from future sales" is the latest pernicious effect of Bushonomics, and now they're doing it at levels unprecedented. The people of the United States, wearing their hats as consumers, in the last 12 months have "spent" more than \$500 billion in expenditures on these delayed-payment programs. **And this means that business and industry are just stealing from future sales in order to maintain sales in the present.**

Of course what happens is that this makes it very difficult for an economic recovery to take hold, because these future payments act like an anchor around the neck of the economy.

This does bode well for the repo market. The repossession industry is the only industry in the country that's growing. (Here's another tip for my readers: Go into the repossession business!) Pawnshops are also doing well, as are money-lending services at 36%. Psychiatrists and mental health facilities are also enjoying record business.

The key word for the future is "vig"—as in what's the magic word for the New Era of Bushonomics? Vig.

Bushonomics is revitalizing an old concept. In order to survive Bushonomics in the future, make the vig—or else.

Let me explain the concept of vig or vigorish for you: If you're a business owner



\$19.95 (+S/H)
Code: THCO (1.0 lb.)

THE CONSPIRATORS: Secrets Of An Iran-Contra Insider

WHAT IF a criminal cabal, a de facto white-collar crime syndicate, took over the U.S. Government and used its systems and operations for its own profit? According to former government operative and now whistleblower Al Martin, this is exactly what has happened.

For example, at a meeting with General Richard V. Secord, Martin was briefed about Iran-Contra operations and allowed to view voluminous CIA

white papers concerning Operation Black Eagle, the code-name for the Bush-Casey-North program involving U.S. Government-sanctioned narcotics trafficking, illicit weapons deals, and wholesale fraud—corporate securities fraud, real estate fraud, banking fraud, and insurance fraud.

Martin has first-hand knowledge of the dirty deals, high-level scams, frauds, and treasonous activities of the U.S. Shadow Government costing taxpayers hundreds of billions of dollars—and still growing. This is a story of true conspiracy, an uncensored look at what really goes on in the back rooms of criminal power politics.

SEE NEXT-TO-LAST PAGE FOR ORDERING OR CALL TOLL-FREE: 1-877-280-2866

HOW THE WAR ON TERROR INTERRUPTED ET CONTACT

BY JIM MARRS

A native of Fort Worth, Texas, Mr. Marrs earned a Bachelor of Arts degree in journalism from the University of North Texas in 1966 and attended Graduate School at Texas Tech in Lubbock for two years more. He has worked for several Texas newspapers, including the *Fort Worth Star-Telegram*, where beginning in 1968 he served as police reporter. Mr. Marrs then became a general-assignments reporter covering stories locally, in Europe, and the Middle East. After a leave of absence to serve with a Fourth Army intelligence unit during the Vietnam War, he became military and aerospace writer for the newspaper and an investigative reporter. Since 1980, Mr. Marrs has been a freelance writer and public relations consultant. He also published a rural weekly newspaper along with a monthly tourism tabloid, a cable television show and several videos. Since 1976, Mr. Marrs has taught a course on the assassination of President John F. Kennedy at the University of Texas at Arlington. In 1989, his book *Crossfire: The Plot That Killed Kennedy* was published to critical acclaim, and within three years had gone into an eighth printing in both hardbound and softbound editions. *Crossfire* reached the *New York Times* Paperback Non-Fiction Best Seller list in mid-February 1992 and remained there for more than six weeks. His book became a basis for the Oliver Stone film *JFK*. Mr. Marrs served as a chief consultant for both the film's screenplay and production. Mr. Marrs has appeared on ABC, NBC, CBS, CNN, CSPAN, the Discovery, Learning, and History Channels, *This Morning America*, *Geraldo*, *Montell Williams*, *Today*, and *The Larry King* and *Art Bell* radio programs.

SEE NEXT-TO-LAST PAGE FOR ORDERING OR CALL TOLL-FREE: 1-877-280-2866



VHS video – 2 hrs.
\$19.95 (+S/H)
Code: JMV (1.0 lb.)

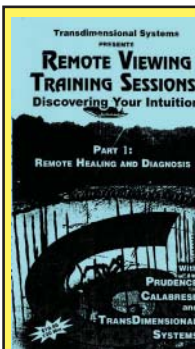

REMOTE VIEWING TRAINING SESSIONS

REMOTE VIEWING TRAINING SESSIONS: DISCOVERING YOUR INTUITION by Prudence Calabrese and TransDimensional Systems.

Prudence Calabrese is the Director of TransDimensional Systems, which provides information solutions to government, corporations, and individuals using an array of services including remote viewing, knosomatics, intuitive counseling, technology transfer, consciousness mapping, physical profiling, and other techniques. Prudence has been teaching people to remote view since 1996. She takes the scientific approach to the study of remote viewing and has developed methods and techniques that go far beyond the restrictive, protocol-based traditional remote viewing first developed over a generation ago at Stanford Research Institute. This seven-part 13-hour video program includes training in Basic Remote Viewing and

Knosomatics, the Collector, Use of the Matrix and Advanced Post-Matrix Exercises. Included as a bonus is a discussion and explanation of techniques in remote healing and use of remote viewing for everyday purposes and career choices. Also covered is a live remote viewing and knosomatics demonstration by Prudence and her team of professional remote viewers as presented for the *London Sunday Times* and HBO. This series takes the new remote viewer all the way through the basic training required to successfully remote view. Actual in-class results are shared, sessions are examined, and the entire process is revealed. Join Prudence Calabrese and her staff as she leads another class into the unknown world and the larger universe. It's all here for you to watch, enjoy, and learn.

Part 1 only
VHS video – 2 hrs.
\$19.95 (+S/H)
Code: RVV (1.0 lb.)

7- tape Set
VHS video – 14 hrs.
\$125 (+S/H)
Code: RVVS (7.0 lb.)

SEE NEXT-TO-LAST PAGE FOR ORDERING OR CALL TOLL-FREE: 1-877-280-2866

or a consumer in this environment, the only way you're going to survive is to pay the vig—or the egregious interest payments on the loans you've made.

Coincidentally, the Bush Regime, in the last 12 months, has quietly allowed the states to relax the usury laws. There is a federal usury limit, although the states regulate individual usury laws within a federal limit. The federal limit is 36%, but a lot of the states have imposed 24% caps.

The Department of Justice had a lawsuit going against the Money Store for the "we'll cash your check this week and you don't have to pay us till next week" crowd. The DoJ finally figured out that you're paying about 78% or so per annum. They had fled a suit on behalf of the government against Money Store, Amsco, and a lot of check cashing places for violation of the usury laws. And that lawsuit has been quietly withdrawn.

When that lawsuit got withdrawn, larger and more mainstream business and industry took it as a sign that you can now literally charge what you want. And that's another group of people who are making money in America—the Vitos and Guidos (as in the Guido Collection Agency who come out to your house to ask why you haven't made the payment like you were supposed to).

But to get back to Bushonomics, both the OMB and CBO have stated that Bushonian budget deficits are not supportable beyond 2009—when they will reach \$1 TRILLION per annum.

Then people who call-in to radio shows ask me what does it mean when they say "unsupportable". When a nation can't sell any more bonds to support its debt, it means economic collapse.

Instead of using the government's own language to say that deficits are unsupportable beyond a certain period of time, you have to tell people that budget deficits will lead to economic collapse. It sounds frightfully shrill to say it that way, but it's true.

I often wonder about how Bush can stay in power, and it's only because he is governing a nation of stupid people, people who are too stupid to understand what he's doing to the nation's economy. If you compare Americans to other first-world nations, people are more adroit and there is a greater understanding of things political and economic and social than there is in the United States.

[Editor's note: There's no argument that it certainly helps to have so many people more focused on shopping at the mall and watching gladiator sports than supervising THEIR government. But SPECTRUM readers are likely to point out that the more direct answer for why Bush "can stay in power" is that those who PUT him in that

puppet capacity of seeming power obviously still want him in that slot—or changes in personnel would "happen".]

Consequently that's why we have leadership in which Iran Contra, IraqGate and BCCI only happen in this nation. They only happen here. Why? Because the government knows it can get away with it because the people are too stupid.

And the United States is where the scams are the biggest—those scams perpetrated by U.S. Administrations. They perpetrate these scams in what I call the American Vacuum of Stupidity. There is a vacuum between the people and government and that vacuum is what I call a Stupidity Vacuum. It's not a Power vacuum. It's not a Recognition Vacuum. It's a Stupidity Vacuum, and this is what allows Bushonomics to happen.

But this is why we added the Market Analysis—to give people the ability to make money even during an Era of Bushonomics.

(Check this week's column at www.almartinraw.com/subscription/marketcommentary.html to see how much money you could have made by following last week's trades.)

You may have heard that the famous Enron Scamscafter, Thomas White, who was the Secretary of the Army, finally resigned. It's surprising he lasted this long since this guy was a liability as soon as his nomination was announced. There has to be a reason for the timing of this "resignation" because the Administration tried to protect him for a long time after he became a liability.

So why are they kicking him out now? It must be that there's something new coming with Enron. What's coming is the second wave of Enron documents that the SEC and other investigative bodies are putting together regarding Enron's offshore accounts and details of their other frauds.

This second wave of documents is most likely going to show some Republican connections. You're going to start to see the linkage. The Bush Regime was getting nervous that these documents would start to document the real linkage between Enron and the Republican Party. There must be a bigger story behind White than what is known, and that's why the Administration got rid of him. Perhaps White was used as some sort of conduit by Enron to funnel money into the Republican Party illicitly.

They should send Head Enron Scamscafter, Ken Lay, to Iraq and have him be the new interim president of Iraq. He could set up all sorts of oil scams and he'd have that country Republicanized in 60 days. He'd turn Baghdad into Scam City—like it never was before.

What the Bush Regime is trying to do (and this has nothing to do with the civil

rights of the Iraqi people) is Republicanize Iraq, and that means Scam City Here We Come. It would go from Banana Republicans to U.S. Republicans.

Why do you think guys like Richard Secord are over there all the time? And speaking of retired Major General Richard V. Secord, this notorious Iran-Contra felon was recently subpoenaed for CTI, his medical scam company, which even had a doctor as a front man. The technology never really worked and it was actually dangerous. Women who had their boobs scanned with these machines said that later their boobs glowed in the dark. It's what they called The Secord Touch.

The *Washington Post* reported: "A federal grand jury subpoenaed Richard V. Secord, the Iran-Contra figure and chief executive of Computerized Thermal Imaging Inc., who sold nearly \$127,000 worth of the company's stock just before a federal panel recommended against approving its leading product."

After Secord sold his stock, the company's stock price fell 63% to close at 39¢ a share.

The *Washington Post* also reported that: "one of the members of the company's six-member board and chairman of its audit committee is Brig. General Harry C. "Heinie" Aderholt, who was Secord's commander in Southeast Asia when both were involved in covert operations for the CIA.... Secord pleaded guilty in 1989 to lying to Congress about his role in the Iran-Contra affair, in which Reagan Administration officials arranged arms shipments to Nicaraguan rebels and to Iran."

But to get back to Bushonomics:

Bushonian budget deficits have been DOUBLING every year. People need to understand that the government fiscal year ends September 30 every year. Of course Bush came in with a \$58 billion budgetary surplus on the day he took office. In his first year (2001), the fiscal budget deficit was \$100 billion. In 2002, it was \$200 billion; and in 2003, it is estimated at \$400 billion.

However, since last November, you have to understand that Bush formally transformed the U.S. economy from GAAP (Generally Accepted Accounting Principles) which Clinton people had put us back on after George Bush Sr. was gone. Then Bush Jr. took us off GAAP and put us back on B-FLAP (Bush Fantasy Land Accounting Principles).

Bush did this last November, when the Administration boldly announced before the bi-elections (it's surprising they had the nerve to do it) that after the elections they would begin once again the Bushonian Scam of raping and pillaging the nation's Social Security Trust Fund as well as the 42 other public trust funds.

In other words, they would count the \$125 billion of surplus revenue payment into the Social Security system that people make through their FICA taxes as “general revenue” and that furthermore they would (as they had done from 1986-1992) begin re-scramming the \$40 billion a year in revenue out of the 42 other public trust funds.

This \$40 billion is a hodge-podge of revenue the government receives from these 42 public trust funds—ranging from Bureau of Land Management mineral rights and royalties, public land grazing fees, Bureau of Indian Affairs federal gaming taxes, special federal taxes, pass through taxes, etc.

The Bush Jr. Administration (as the Bush Sr. Regime also did) is now simply counting this \$40 billion of payments every year as general revenue, instead of segregated payments for their underlying beneficiaries.

Therefore, in order to convert B-FLAP (trying to figure out the annual federal budget deficit), you have to add \$165 billion per annum (under a Bush Administration) on top of whatever the Bush Administration claims the federal budget deficits are, in order to convert B-FLAP into GAAP.

That is a point I’ve had to make a thousand times, and I know people still don’t understand it. That’s why it needs to be stated and restated again, especially if they see it in print.

Therefore, it is estimated that this year the federal budget deficit will be \$400 billion for fiscal year 2003 ending September 30. However, in terms of GAAP (or “real money”) the deficit would be \$565 billion because you have to add the \$165 billion on top.

GAAP or Generally Accepted Accounting Principles is the normal standard of accounting principles applied in business and industry and within government in order to calculate revenues, payments, debts, liabilities etc.

B-FLAP or Bush Fantasy Land Accounting Principles is where you take government revenue, which is supposed to be segregated for other purposes, and you count it as general revenues.

B-FLAP then creates continuing deficits within the 43 public trust funds.

Remember the Bush Sr. Administration (1986-1992) sucked \$3.88 TRILLION out of the Social Security system. The Bush Administration gets around that (you have to put something in there) by replacing the hard cash they sucked out with 3-1/2% non-marketable non-convertible restricted U.S. Treasury bonds with no fixed maturity date—essentially worthless paper.

GAAP, however, does not distinguish between a restricted instrument and a full-faith-and-credit marketable government

instrument. Therefore they are able to count these worthless instruments as what is known in accounting terms as “near cash equivalents”. That is how they make up the underlying deficits.

The 3-1/2% coupons that these instruments bear under a GAAP system should be paid from the U.S. Treasury every year into these accounts to at least cover the coupon. Therefore that would represent a current burden of about \$100 billion per annum just in the Social Security General and Disability Trust Funds—and this does not include what the U.S. Treasury should be paying back into the 42 other public trust funds.

But the money is not paid under a Bush Administration. It was paid in the second Clinton term, but now that Bushonomics is back, that \$100 billion of interest on these non-marketable securities is not paid. It is simply put on an accrual basis, wherein the coupon payment accrues indefinitely in arrears and is counted as part of the principal liability or principal debt.

People have asked me why it is that the Social Security deficit was \$3.8 TRILLION when Bush Sr. left office. This constitutes the \$3.8 TRILLION which the Bush Administration stole.

There is no way around it. They didn’t bleed it out. They didn’t convert it. It was unlawfully stolen in order to mask or obfuscate the actual size of Bushonian budget deficits that were created during the 1986-1992 timeframe.

Why is that \$3.8 TRILLION deficit today a \$5.3 TRILLION deficit? How did it grow?

It grew by that \$100 billion per year coupon payment that is not being paid by the U.S. Treasury, but being accrued into the principal amount of the debt. That’s how they do it.

In B-FLAP, you convert interest payments owed into principal accrual of debt. Therefore the debt simply increases.

However since you’re not servicing the debt and you’re not counting the Social Security debt as part of the overall federal National Debt, then it doesn’t really make any difference.

The Bush Administration claims they can do this under B-FLAP. Their position has always been (because it is somewhat nebulous) that Social Security

debt does not constitute a direct liability of the United States Treasury. Therefore, it should not be included in the calculations of the overall federal National Debt.

Technically they’re right about this. The government has no direct obligation to fund any deficit that should occur in the Social Security Trust Fund. The only obligation the government has is the continuation of payments.

If there is a deficit in the Social Security Trust Fund, the government can (and is now doing so) reduce future payments—and alter the age at which you can collect those payments.

The laws governing U.S. Treasury’s commitment to the 43 public trust funds is exactly the same as those laws governing the U.S. Treasury’s commitment to so-called GSEs or Government Sponsored Enterprises—i.e., Freddie Mac, Fannie Mae, Ginny Mae, Sallie Mae, etc. It is only an “implied” indirect obligation.

Brokerage firms, for instance, claim that those Ginnie Mae and other funds are guaranteed by the government. They’re not. There is no direct obligation of the U.S. Treasury to guarantee the GSEs. That’s why they are called “quasi-governmental” agencies, because they are 50% publicly owned and 50% owned by the U.S. Government. All of the liability is ultimately transferable to the underlying public shareholders.

The U.S. Government has no ultimate liability pursuant to the maintenance or funding it guarantees to government-sponsored enterprises.

The Bush Administration is scared to death of putting the U.S. Treasury in the capacity of directly guaranteeing the Social Security Trust Fund. If the Democrats are able to change the law, then the accumulated so-called Social Security deficit would: (1) have to be counted as part

William Cooper: Death Of A Conspiracy Salesman

On November 5, 2001, William Cooper was shot to death by sheriff’s deputies in a gunfire exchange. Who was Bill Cooper? Was he a true patriot? A tough survivalist? Or simply a fanatic?

Some knew him as a UFO “expert” (claimed insider information on government knowledge of extraterrestrials living among us)...a conspiracy theorist...a former Navy Intelligence operative...and the person the President once called “the most dangerous man on American airwaves”. Cooper always said he acted from his “conscience” and sought to warn all Americans of the dangers of the New World Order, creeping socialism, and our own brand of Nazism. Here is the inside story, as told by a fellow patriot and government whistle-blower. Commander X has collected together for the first time Cooper’s thoughts and finds on such subjects as: The Illuminati • The Kennedy Assassination • MJ-12 and the UFO Cover-Up • Area 51 • The AntiChrist • The World Trade Center Disaster • Gun Control • Skull and Bones Society.



\$16.00 (+S/H)
Code: WCO (0.75 lb.)

SEE NEXT-TO-LAST PAGE FOR ORDERING OR CALL TOLL-FREE: 1-877-280-2866

of the overall national debt, and (2) the U.S. Treasury would have to start to service that debt at a cost of more than \$100 billion a year simply to maintain the debt (not even paying down the debt).

That \$100 billion a year in turn would pass through directly to the bottom line of Bushonomics-created federal budget deficits. This in turn would raise interest rates and there would be many more repercussions.

Under Bushonomics, all economic growth is a fallacy. It doesn't really exist. It only exists on paper. The total debt of the U.S. Government exceeds its total assets. The total debt of all business and industry also exceeds their total assets.

And then there's the pro forma loophole. All publicly held businesses and industries report their earnings on both a pro forma and an adjusted basis. The adjusted basis is always less than the pro forma.

Pro forma means according to the broadest interpretation of GAAP standards. Fully adjusted would be taking out all special payments, special-interest payments, accrued reserves, accrued contingent funds for future liabilities, etc.

The analogy of business to U.S. government is that all government statistics are issued on a pro forma non-adjusted basis.

The U.S. Government does not issue fully adjusted numbers, and it's only pro forma numbers. If the U.S. Government was forced to issue fully adjusted revenue numbers, then it would have to start to make contingencies for future debts and obligations—something the Bushonian Administration is steadfastly against.

In 1995, when the Clinton Regime attempted to push through the recalculation of pro forma to include adjustments, the Republicans fought it like hell and they defeated it, knowing that when they got back into office (had they not defeated it), it would have closed again another loophole which allows Bushonomics to continue.

If the U.S. Treasury were forced to make

capital surplus reserves for future liabilities, both actual and contingent, the deficits would balloon.

We get back to this one key point which Republicans who call-in to radio shows ask: If we're in such bad shape, why is it that the total debt service of the U.S. Government is only 24% of revenue, while in Britain it's 37% of revenue, therefore making the U.S. look pretty good economically?

And I always have to say that the reasons debt service is so low is because the United States, unlike the other countries you're talking about, only services about half of its outstanding federal debt at any one time—because so much debt is not counted as debt, such as the deficit in the Social Security Trust Funds.

The accumulated deficits, which now total more than \$2 TRILLION in the 42 other public trust funds, are also not counted as debt. This is at the very heart of Bushonomics.

Of course, a country that has the ability through "creative accounting practices" to only service half of its debt is always going to be able to stay between 18% and 26% of the budget. That's all it will have to commit to debt service because, as time goes by under Bushonomics, the government services less and less of its debt.

This gets a little more complex. People ask me how you can be a government and actually service less of your debt over time insofar as the principal amount of that debt continues to rise.

You can do that under the crafty smoke-and-mirrors accounting procedures which Bushonomics incorporates. You do it by reducing estimated future liabilities vis-à-vis that debt.

The Social Security Trust Fund is a classic example. Each year that goes by, the future liability of the Social Security Trust Fund grows as the population growth continues. Furthermore, future liability grows as the median lifespan of the nation (now at 77 years, an all-time high) continues to increase.

However, to get around that, so they do not have to show an even larger future contingent liability, the government simply recalculates the basis of future payments, to make those payments lower. This is the plan that is the Bushonian 2029 Social Security Readjustment Plan, wherein between now and 2029, the age at which you can collect social security gradually rises, and it's not going to be 62 and 65. It will rise to 65 and 67, and then from 67 to 70. The Bush Administration tries to justify this by saying that the median lifespan of the nation is growing.

To keep Social Security solvent, you have to reduce future demand for Social Security, and the only way you can do that is to do what the Bush Regime has done, and that is to: (1) make sure people can't collect Social Security until they're older, which reduces financial demand on the fund, and (2) annuitize Social Security, which is incorporated into the 2029 *Social Security Readjustment Act*.

Social Security payments will no longer be calculated the way they have been since 1935, when the fund was first established. That is, there won't be a fixed payment amount as there has been in the past. To some degree, there is some justification for this because there has been a vast increase in the median lifespan of the people.

In the future, beginning in 2017, Social Security payments will be calculated on an annuitized basis, i.e., an actuarial table, instead of a fixed payment scheme. That will immediately reduce Social Security payments by at least 50%.

The Republicans feel perfectly free in talking about annuitization because they understand that the American people don't know what they're talking about.

The Social Security Trust Fund must be annuitized by 2016-2017. These dates are important because the general trust fund that pays pensions to old people cannot financially survive beyond 2017 without a reduction in payments.

This is the terminus date of the old fixed-payment system, which cannot be sustained beyond 2017. Therefore, in the annuitization process, not only would retirement benefits drop by approximately half, immediately, but also, benefits for future generations would gradually decline, as the median lifespan of the nation would increase. Payments will now be calculated on an actuarial table.

**Just Another No-Brainer Week In
The New Bushonian Age**
(5/12/03)

There's two types of no-brainers: the kind of person who is glued to the no-brainer Domino Pizza commercial. (What's better?)

MINDFIELD

*The Untold Story Behind CIA Experiments
With MK-Ultra & Germ Warfare.
America's Great State Secret
by Gordon Thomas*

Now published for the first time as an original
e-book (only available via the Internet).
(Author of: *Seeds Of Fire: China And The Story
Behind The Attack On America*)

To download your copy, go to:
<http://spectrum.globe-intel.net>
Price is \$20.00

MINDFIELD

THE UNTOLD STORY BEHIND
CIA EXPERIMENTS WITH
MKULTRA & GERM WARFARE



Gordon Thomas

One pizza or two?) Or you can be the kind of no-brainer who reads *AlMartinRaw.com* and makes money. This separates the no-brainers who survive and those no brainers who thrive. Which no brainer would you rather be?

It's hard not to keep beating the drum on this, but this column, and the economic market commentary column, really are a service to the nation. You could even call it an *Al Martin Raw* Economic Rehabilitation Program. We'll get you off your Prozac. And you'll make money and restore your 201K account, that used to be a 401K account before the election of Junior.

(Remember: Al Martin is not a CFP or RIA, and these are just floor-trading suggestions.)

All the suggestions I made last week based on floor commentary, for example, came true. When I said buy the June T-bonds on any dip below 113-1/2 to sell on the ensuing rally 114-5/8, you would have been able to capture at least at 1-1/4 point profit (\$1250 per contract).

What's better? To have \$1,250 of new money or two pizzas?

But people really need to understand the realities of "offshore banking"—especially now when it becomes crucial to protect your assets, or anything you may have left after the scourge of Bushonomics. Popular media has marginally connected this term with money laundering and tax evasion and illicit political funding, but it's really something you need to research for yourself.

You may have heard about former drug czar and Secretary of Education Bill Bennett and his gambling problem. They're even calling him the "Bookie of Virtue" in honor of his self-righteous and obviously hypocritically titled *Book Of Virtues* (sic).

(According to several reports, Bill Bennett even scammed his ghostwriter and didn't pay him for his work. You didn't think he actually "wrote" the book himself? How's that for "virtue"?)

Every time there was a state which didn't have gambling but wanted it, they would march out Bill Bennett to talk about the evils of gaming in order to throw a sop to the Republican Religious Right. But Bennett says that gambling is not evil and it takes an adult to control it. As reported by *Newsweek*, his losses were in the \$8 million range for the last ten years or so.

This is another example of the disingenuous right-wingers and how they used to put this guy out front to talk about anti-gambling. When he was a "Drug Czar" they started the policy of using taxpayer money to help out narcotics users and gamblers to help the "poor souls". But for a Republic Role Model—nobody is pointing out how disingenuous this is.

TRANCE Formation Of America

This is the documented autobiography of a victim of government mind-control. Cathy O'Brien is the only vocal and recovered survivor of the CIA's MK-Ultra Project Monarch mind-control operation. Chiseled deep into the white stone of the CIA's Langley, Virginia headquarters is a partial verse lifted from the Holy *Bible* and writings of Saint John: "...and the truth shall make you free." This statement, like the agency, is total unreality. The building that it is engraved upon houses the world's most successful manufacturer of lies to facilitate psychological warfare. The "Company" uses truth and technology as their raw materials to produce "pure" lies for control of you and America's allies. Within the pages of *TRANCE Formation Of America* you'll find the truth.

U.S. GOVERNMENT MIND-CONTROL

On August 3, 1977 the 95th U.S. Congress opened hearings into the reported abuses concerning the

SEE NEXT-TO-LAST PAGE FOR ORDERING

CIA's TOP SECRET mind-control research program code-named MK-Ultra. On February 8, 1988, an MK-Ultra victim, Cathy O'Brien, was covertly rescued from her mind-control enslavement by Intelligence insider Mark Phillips. Their seven-year pursuit of Justice was stopped FOR REASONS OF NATIONAL SECURITY. *TRANCE Formation Of America* exposes the truth behind this criminal abuse of the unconstitutional 1947 National Security Act.

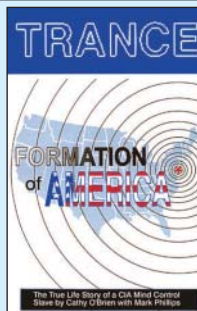

\$18.00 (+S/H)
Code: TFA (1.0 lb.)

PUBLIC NOTICE: This book contains sexually explicit quotes and irrefutable anatomical details of perpetrators and is therefore recommended for mature readers only.

OR CALL TOLL-FREE: 1-877-280-2866

And speaking of disingenuous Drug Czars, remember when General Barry McCaffrey was the Drug Czar and he said let's fill up the prisons. Later it turned out that the General owned stock in companies that owned the nation's privatized prisons, as well as other prison suppliers,

And then there are the stories about Bill Bennett and his partying with Peter Fonda in Montana. They don't even have to call Ollie North's drug delivery service. They get pizza and coke right at the door.

But Bill Bennett has had this reputation of being such a "good and virtuous" man and he doesn't have any vices.

In other news, Ambassador Paul Bremer has been named as the new dictator of Iraq—a U.S. dictator, mind you. Bremer, of course, is the former shill for Henry Kissinger. He is, after all, the Henry Kissinger front-man. Bremer was also an Ambassador at Large and former deputy Secretary of Defense.

As mentioned in my book *The Conspirators*, Bremer is connected to a lot of Bushonian swindles. He was president of Kissinger Associates, as well as connected to all the usual right-wing deals, but he essentially acts as a front for Kissinger. He goes to countries that Kissinger is frightened to go to, because he will be subpoenaed or charged with war crimes. If you're Henry Kissinger, you need somebody to front for you.

But why Bremer is really there is to act as a coordinating function for Kissinger's office in Baghdad and Kissinger clients such as Halliburton and Fluor. He's there to make sure a certain group of companies receive all of the contracts. He is the defector Bostonian Cabal's Man in Iraq.

The Administration gives good government awards to those in business or to members of Congress, but this year, they

took out a full page ad in major newspapers around the country to announce that the award in the New (Bushonian) Era went to Boeing Chairman Phil Condit and to Senator John Warner. Why? Because obviously the defense industry is the second largest source of Republican Money and the first largest source of Bushonian Cabal Faction Money within the Republican Party. Boeing is also the largest contributor to John Warner and his campaign committees and so on. And that is "Good Government" according to the Bush Administration.

Warner has shown his appreciation by consistently voting against all investigations of Boeing for fraud regarding the handling of government contracts and by using his influence to steer ever more government contracts with no fixed delivery dates and unlimited cost over-runs to Boeing and/or its defense industry partners

There was a follow-up on the Vermont high school student who got into a big ruckus because of the George Bush poster he had on the inside of his locker. This picture of George Bush had a piece of duct tape over Bush's mouth—as a protest. (The student was just looking for a way to use up the duct tape he bought during the last Orange Terrorist Alert.)

Anyway, a group of right-wing high school boys (they called themselves the "state security boys"), who are rabid pro-Bushers, went to a local cop who apparently was also a notorious naïve flag-waver. This flat-topped hairdude cop, without the knowledge of his superiors in the police department, marched down to the high school and demanded that the principal open this boy's locker, and the principal wouldn't. He told him that he would have to get a warrant. The cop knew he couldn't do it because there hasn't been any test case on

warrants for the *Seditious Publication Act*.

So the cop then waits till after dark, and breaks into the high school, and goes to the kid's locker, and breaks it open. He rips the poster out, apparently intact, then presents it to the principal the next day. He calls the Office of Homeland Security and then demands that this kid be expelled. The cop evidently yelled and threatened the principal, and called him a dangerous left-winger who promotes sedition among his students by unlawfully allowing them to display anti-Bushonian materials. But the high school principal wouldn't budge.

Now the cop, acting as an individual citizen, with the support of the Office of Homeland Security, is now suing the principal and the school board in an effort to get the principal to enforce the new expanded *Seditious Utterance And Publication Law* to expel this student.

Apparently the cop was surprised that the principal stood up to him because, according to the cop, "liberals don't have any backbone".

The Republican National Committee has made it official: we will have a Bush-Cheney ticket in 2004 (providing that the Vice President is not indicted for any sundry malfeasances pursuant to the ongoing SEC and other regulatory agencies' investigations of fraud committed at Halliburton while the Vice President was chairman). However, the RNC assures the public that, although there may indeed be indictments, Vice President Cheney will not be among those indicted. (I'd like to know how they know that in advance, but I guess

it's because they're members of the Bushonian Cabal. Obviously they know the conclusion of the "investigation" even before it gets started.)

You can imagine Cheney's former high-ranking associates at Halliburton looking at each other and wondering who's going to get the word "scapegoat" written on their back.

As they pointed out, most of the former high-ranking people at Halliburton who were close to Cheney when he was Chairman are of course Arch-Bushonian Cabalists. Several of them are RNC Committee-Men. Most of them have already left for their non-extraditable Cayman Island retreats—and taken their ill-gotten millions with them.

There was another failure at the Bushonian LCB (Lie Coordination Bureau)—or, How the Good Humor Man Became a Terrorist in the Bushonian Regime.

[*Editor's note: Al is referring back to a wonderful column he wrote on Bush's need for a Lie Coordination Bureau that's in the November 2002 issue of The SPECTRUM.*]

In the morning, the infamous Deputy Secretary of State Richard Armitage of Iran-Contra infamy announced that he was absolutely positive that biochemical weapon facilities would be discovered in Iraq. In the afternoon the U.S. Army "coincidentally" found a so-called biochemical weapons mobile laboratory in a truck.

This turns out to be the same ice cream truck they trotted out several months ago as

"proof"—under the presumption that nobody would remember they showed a picture of this truck. And, of course, the American people don't remember what happened yesterday. It was kind of beat-up looking and parked in a ditch, half tipped over in Northern Iraq. The U.S. Army proclaimed it to be the "Infamous Biochemical Mobile Weapons Laboratory" in question.

In fact this is the same truck that Secretary of State Powell had shown in the UN briefing prior to the commencement of hostilities in Iraq which the Secretary had said that the CIA had identified through satellite photographs as a "biochemical mobile weapons laboratory".

However the truck in question, in Hans Blix's response to the Secretary of State's allegations, was that this was in fact an ice cream truck that had already been identified by UN inspectors. It was refuted several days later.

And wouldn't you know it—the Good Humor ice cream truck made a comeback.

This is the first time I had ever seen it close-up in a live photo. The photo that Secretary of State Powell presented was taken from 500 miles up. The UN-submitted photo was taken from about 30 feet away, and you could see the little panel that lifts up on the side and the Formica counter that comes down. But this was the first time I had ever seen it close-up. The Iraqis painted it in a camouflage brown sand color, but on the top panel of the truck you could still see the faded "Good Humor" Ice Cream written on the top of it. This was on CNN.

But nobody in this country actually remembers. If you did a poll of how many people remember the incident of the ice cream truck from Powell's UN testimony, maybe 3/10ths of 1%. They were safe in this. And its our job to expose it and remind people.

Here's what they're doing. First Armitage announces that we're sure we're going to find it. And then "coincidentally", six hours later, the Army finds this much-vaunted "Mobile Bio-Chemical Weapons Production Facility". Wow, you couldn't even fit all those initials on the Good Humor ice cream truck logo.

Where are those people at the Lie Coordination Bureau when you need them?

Another egregious example of Bushonian market manipulation in order to benefit the Republican Elite and the Friends of Bush Society was on the CNN crawl tape, which reported that former deputy defense secretary Richard Perle secretly gave advice to "Republican insiders" to short U.S. equity markets prior to the invasion of Iraq. This was done in order to generate profits for themselves AND for the Republican Party.

Late in the day, interestingly enough,

Al Bielek on CD-ROM

This is the most in-depth compilation of interviews with survivors of the Philadelphia Experiment and Montauk Project to date on one computer CD. The information comes from the memories of those who were interviewed. Because these projects are so secretive, gaining hard evidence is nearly impossible. However, that doesn't mean the projects never happened.

There are many out there who do not want you to know the truth about these projects. Use your own judgment as you hear the words of these survivors. Use this information as the beginning resource to help you onto your own research track.

The five people featured on this CD all testify that they worked with Al at the Montauk Project, and some even remember him as Ed Cameron during the Philadelphia Experiment.

CD INTERVIEW CONTENT:

Al Bielek

Life of Ed Cameron
Visit to Alpha Centauri
Philadelphia Experiment
Trip to 2137, Trip to 2749
Trip to Mars and 100,000 B.C.
Life of Al Bielek
History of Montauk
Montauk Boys Program
Montauk Mind-Control Program
Montauk Time-Travel Program

Psychic Operations Program
Duncan Cameron Involvement
Duncan Cameron
Memories of Montauk
Stewart Swerdlow
Being a Montauk Boys Programmer
Human Genetic Manipulation
Involvement With E.T.s
Preston Nichols
Working With Bielek at Montauk
Stealth Technology Development

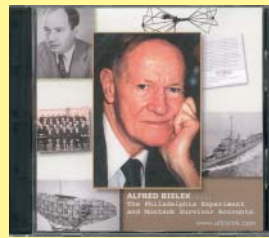

\$24.95 (+S/H) Code: BIE (0.5 lb.)

CD-ROM CONTAINS OVER 25 HOURS OF AUDIO INTERVIEWS ENCODED IN MP3 AND REALAUDIO. CD IS IBM, MAC, AND UNIX COMPATIBLE.

Mind-Control Development

Montauk Boys Program
Larry James
Operating the Time-Control Program
Experiments With Time Travel (JFK, Civil War, WWII)
Involvement With Bielek
What Happened To Ed Cameron?
Dr. James F. Corum
Replication of Radar Invisibility

SEE NEXT-TO-LAST PAGE FOR ORDERING OR CALL TOLL-FREE: 1-877-280-2866

CNN stated that they would not run the story, no doubt under White House pressure. It's interesting how Bushonian Market manipulation works. Perle was telling wealthy Republican insiders to short U.S. equity markets at the very same time the Bushonian shills like Larry Kudlow were out in force telling the "little investors" to buy, buy, buy.

By the way, this is a principal component in the Bushonian Agenda pursuant to the "continuous consolidation of money and power into higher, tighter, and righter hands". This constitutes a direct transfer of wealth from the so-called "Joe-Sixpack 300 Shares Buyers" or "Sucker Buyers" into wealthy Republican hands.

When Bush appeared at a commencement address at the University of South Carolina, there was no applause—and when there was, it was, how would you say, very lackluster.

Bush now travels to all these functions (which seems to be just about every day) in which he continues to preach to the choir. There is never a hostile crowd, but now he goes with a special group of political handlers. It's incredible to what extent Bush's appearances are now stage-managed. Now they position these handlers at key points in the audience.

They even unbutton their jackets so you can see their guns in their shoulder holsters. They have large signs which you don't see from the TV camera perspective. The signs say: "Applaud if you know what's good for you."

Who needs canned laughter or applause when you have your goons in the audience?

Sedition & Treason In The U.S. Imperial State (5/19/03)

The most important story last week was: The Department Of Homeland Security Pursues Seditious Democrats.

The 50+ "Fugitive Democrats" were the Texas state legislators who were hiding out at the Holiday Inn in Ardmore, Oklahoma. Governor Rick Perry of Texas, an Arch-Bushonian Cabalist, in fact issued arrest warrants for them under the *Seditious Utterance And Publication Act*, insofar as they were obstructing the will of the State (not the state of Texas, but the Nation State. Note the capital S.)

And what's behind this fracas? It's a redistricting bill that's being sponsored and pushed by Congressman Tom Delay. The Democrats are asking, and rightfully so, why the U.S. Congressman from Texas is involved in an issue which should be a state issue. This should be decided by the Texas state legislature, not by a United States Congressman—and furthermore not by an Arch-Right-Wing Nut like Delay.

If the redistricting bill is passed, it will eliminate between 5 and 7 Democratic seats in the State of Texas. Delay stated in an interview that the Democratic Texas delegation has "consistently stood against the Leader". Those are his words. He means George Bush Junior. He looks at it as his God-given mission to eliminate the Democratic Party from Texas, and in so doing make Texas the first Sedition-Free State in the union.

Although the media is trying to put a humorous spin on it, there is a more serious (and sinister) side to the situation. The Texas Republicans, particularly the Speaker of the House Tom Craddick, as well as Texas Governor Perry and Congressman Delay, are using this incident to do what they say they intend to do—eliminate the Democratic Party in the state of Texas.

They've even made playing cards with the Texas Democrats on them, implying that they are terrorists like the DoD playing cards with the Wanted Iraqis.

There was evidently a letter sent out by the Republican Committee caucus of the Texas state legislature urging loyal Texas Republicans to start taking down the names of their Democratic neighbors, whom they feel may be harboring seditious views.

And the 9/11 Presidential Commission Investigative Report has still not been released, although Democrats in Congress have tried to force its release. The report has long since been done. This is the report by the 9/11 Investigative Committee chaired by Henry Kissinger, who resigned because he refused to disclose his Middle Eastern clients, particularly his Saudi clients. After Kissinger's resignation, the committee was chaired by Paul Bremer, who is currently the defacto Overseer of U.S.-Occupied Iraq.

White House spokesman Ari Fleischer said he doesn't care how much pressure there is; the report will not be released until all information that would embarrass the Saudi government has been removed. But the Democrats are beginning to push the concept of backing away from Saudi Arabia, a concept that scares the Bush Regime because of their deep financial interests there.

They don't care about strategic oil or political ties. It all comes down to money—the Bushonian Cabal's personal financial interests in Saudi Arabia, including the personal interests of the Bush and Cheney families.

But as I've said on radio shows before, these Democrats who are holed-up in the Holiday Inn SHOULD have been arrested. Why? Because they were in clear violation of the relevant statutes of the *Sedition Act* as now revised and expanded, thanks to the *U.S.A. Patriot Act*.

To put this in some context, the president

now has the absolute authority, under the expansion of the *War Powers Act Of 1947* therein contained in the *U.S.A. Patriot Act*. This expansion of these powers means, in this case, that once the president declares a State of National Emergency, which he did on September 14, 2001, three days after the 9/11 incident, that effectively authorizes the president to do a variety of things: postpone elections, cancel elections, impose a state of martial law, order the arrest of any legislative or judicial members of government, etc. Those powers had always existed. However the president couldn't act without the consent of Congress. He couldn't assume these imperial powers without a super-majority vote in Congress and without a majority opinion from the Supreme Court.

The *U.S.A. Patriot Act*, however, sidelines the legislative and judicial branches from their oversight role—legislative oversight or judicial review—after the president declared a state of National Emergency. It gives the president the power to act by edict.

Therefore, with the extension of the *Seditious Utterance And Publication Act*, the president has the right to authorize the attorney general to swear out arrest warrants against any member of any legislative branch of the government of the United States which includes, by the way, state legislators like in Texas—should the legislators act to obstruct or otherwise frustrate the will of the State or impede its operations.

The Department of Homeland Security, not the Department of Justice, is now charged with arrest of these Texas Democratic legislators. Once the president has declared martial law, the Department of Homeland Security would assume many of the powers of the Department of Justice.

We are currently living under a State of National Emergency, a lesser act than the imposition of the state of Martial Law, which the president has not yet imposed, but he still has as much power.

Here is the key difference between the old law and the new law. Under the old law, short of the imposition of martial law—i.e. the imposition of a declared state of national emergency—the president had to seek legislative review and judicial oversight. That is the key difference. He no longer has to do that.

However, now the president, since he has declared a state of National Emergency, can now rule by edict and has assumed, therefore, extra-legal powers. To some degree, that sidelines the Department of Justice, because the DoJ is not authorized to carry out arrests under extralegal proceedings. That's one of the reasons the Office of Homeland Security was created.

By this reasoning the Seditious Democrats in Texas are endangering the

CLASSIC RESEARCH WORKS by EUSTACE MULLINS

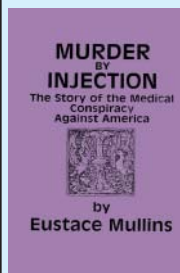

361 pages

MURDER BY INJECTION *THE STORY OF THE MEDICAL CONSPIRACY AGAINST AMERICA*

Eustace Mullins unveils the Conspiracy to deny you low-cost alternative health-care and how federal agents commit acts of "Criminal Syndicalism" to protect the profits of the "Drug Trust". The world's 18 largest drug firms are listed. Some of the topics covered are: Profits of Cancer, AIDS, Contamination of the Food Supply, Death and Vaccination, The Rockefeller Syndicate.

\$20.00 (+S/H) Code: MBI (1.5 lb.)

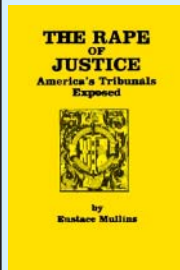

535 pages

THE RAPE OF JUSTICE *AMERICA'S TRIBUNALS EXPOSED*

This book reveals the "Secret Code" which judges and lawyers use to deny you your unalienable and civil rights protected by the *Constitution*. Some of the topics covered are: Legal Anarchy; The Origin of Law; A Plague of Lawyers; Judge Not; The Supreme Court; The Department of Justice; The Court as Arena; Freedom of Speech, Anyone?; Taxation Without Hope; The Taxing Power; Mullins on Equity; Our Legal Future.

\$22.00 (+S/H) Code: ROJ (1.75 lb.)

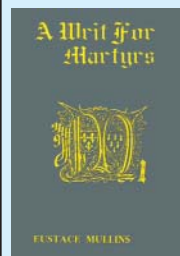

A Writ For Martyrs by Eustace Mullins

This is a fully documented exposé of the atrocities which federal agents regularly commit against American citizens.

This book reproduces 121 pages from Eustace Mullins' FBI file, which he obtained only by the personal intervention of a college classmate, Senator John Warner, Rep. Of Virginia. The FBI refused for two years to send Eustace his files through *Freedom of Information Act*

inquiries. When Eustace found it, he discovered a plot by the FBI, with 60 pages of memos, in which J. Edgar Hoover personally ordered that Eustace be committed to a mental institution for life.

On the basis of these revelations, Eustace obtained two "Default Judgments" against the FBI in Federal Court. One judgment was for \$50 million, and one for \$35 million, which remain on the books today.

This book also documents atrocities committed against Eustace's handicapped sister, his ailing mother, and his invalid father, who all died of heart attacks after daily harassments by the FBI terrorists.

\$20.00 (+S/H) Code: WFM (1.0 lb.)



Money And The Conspiracy Of Evil Conspiracy Con 2002 Lecture (2 hrs.)

Sixty years ago Eustace Mullins was a protégé of literary giant Ezra Pound, who understood central banking and its relationship with world unrest. He has been a respected researcher for over 50 years.

He describes the real manipulators behind all major wars, the Cold War, the Stock Market, the Medical Scam, 9/11, Terrorism, and more.

To accomplish all this, the "perpe-traitors" control the government, the schools, and the media, while keeping us in unimportant jobs, and stealing most of our earnings. For these purposes the Central Bank is the only mechanism that works.

VIDEO TAPE: \$20.00 (+S/H) Code: EMV (0.75 lb.)

AUDIO TAPE: \$10.00 (+S/H) Code: EMA (0.5 lb.)

Please see next-to-last page for ordering
information or call toll-free: 1-877-280-2866

security of the State because they were obstructing a vote in the Texas legislature. Therefore they were impeding the will of the State (the Nation State). This has nothing to do with the bickering over redistricting in Texas. It doesn't make any difference what they were voting for, whether it was for more fire hydrants or whatever else.

The Texas Democrats are therefore required to be there. Why do you think the governor had authorized using his powers under the *U.S.A. Patriot Act*? The governor stated that he would authorize the state police and/or the Texas Rangers. In other words, he would order the arrest of these legislators if they were in the state of Texas. This is a power that is granted to state governors under the *U.S.A. Patriot Act*.

Since the Texas Democrats were out of the state (beyond his jurisdiction), he had to go to the attorney general of the United States, who then in turn had to go to the Department of Homeland Security, because the arrests at a federal level would have been an extra-legal proceeding. Not illegal, but an extra-legal proceeding, which would have required the Department of Homeland Security to actually order the FBI or the U.S. Marshals' office to place these guys under arrest once they were in federal jurisdiction—the minute they crossed state lines.

When they do not perform their constitutional duties, the Texas Democratic legislators become liable then since they are acting in a seditious capacity.

Had the next step been taken, had Deputy Reichsfueherer Ridge of the Department of Homeland Security actually ordered the FBI or the U.S. Marshals' office to take these people into custody, and had they then continued to evade that custody, then the charges would have been upgraded to treason against the Republic of the United States.

If they attempt to evade arrest when in federal jurisdiction against extra-legal proceedings (the United States now being in a state of declared National Emergency), the charges would be upgraded to treason. Here's how they make the leap. This is also part of the new law, which has been vastly expanded. It's called "implied harboring".

To make the leap from sedition to treason, here's what needs to take place: First, the Department of Homeland Security would have had to have stated that the wayward legislators were attempting to impede or frustrate the will of the State. Insofar as it was obvious that they were not going to vote for a proposal by the will of the majority of the said legislative body, they were attempting to impede the will of the majority of a governing body. That means that they could have been declared as harboring views contrary to the security of the State and the domestic tranquility of the people. That is treason. (It didn't used to be, but now it is.)

The harboring is implied because the reason they fled was to obstruct the will of the majority.

The *U.S.A. Patriot Act*, in conjunction with the expansion of the *Seditious Publications And Utterance Act* and the vast expansion of presidential powers under the *War Powers Act Of 1947 et al*, then significantly waters down constitutional guarantees under a bicameral system of government.

We are now in a state of National Emergency, which means that constitutional bicameral guarantees of legislative bodies DO NOT exist.

It can be declared "seditious" or "treasonous" for a minority in a legislative body to "obstruct" the will of the majority. That now translates into obstructing the will of the State. Because the President says so. The President is the Leader of the majority party. His power by edict, after the imposition of a state of National Emergency, is ABSOLUTE and UNCHALLENGABLE by any legislative or judicial body.

The only body that can review the expansion of powers is the new Supreme National Security Court in Washington, not to be confused with the old National Security Court.

There is a new National Security Court as well as a New Supreme National Security Council. Remember: now we have four; we used to have two.

The president directly chairs and controls the new National Security Court and the New Supreme National Security Council. You can tell the difference between the “new” and the old because it has the word “Supreme” in it.

People don’t seem to understand that, with the passage of the *U.S.A. Patriot Act* and subsequent pieces of legislation, the president has fulfilled the requirements by the imposition of a declared state of National Emergency to now act in this extralegal capacity given to him with the passage of these various pieces of legislation.

The president now has the power to act as the Supreme Leader of the State.

George Bush actually said that if he was a dictator, it would make it much easier.

The word “dictator” is not used in the text, which comprises HR 3601, which now is actually over 4000 pages, when you include the subsequent legislation related to it.

Instead of using the word “dictator” you will see the word “supreme” used—as in supreme power, Supreme National Security Council, the Supreme National Security Court, the Supreme Office of World Internet Police, etc.

Anytime you see the word “supreme” used in the creation of these new federal agencies, offices, or bureaus, it means that the president can direct these agencies, etc., to act in an extra-legal authority, which is tantamount to dictatorial rule.

This is the ineluctable conclusion—and we have allowed this to happen in the United States of America.

As soon as Orrin Hatch and John Warner, the Chief Bushonian Minions of the Republican-controlled Senate, mark up and pass the NICA (*National Identity Card Act*) funding bill, which failed in last year’s Democratic majority-controlled senate, and the bill to overturn the *Posse Comitatus Act Of 1878*, then the president’s power will be absolute.

We will then go from a semi-dictatorship to a full dictatorship. They won’t need any more pretenses.

This will be after the *Posse Comitatus Act* is overturned. This is the real Bushonian agenda—and they’ve said so, so that none of this is all that secret. The Bush Regime has made their agenda rather public. They’re not acting secretly. **They want the militarization of domestic law enforcement.** They have already set up all the offices and machinations, to wit the new NorthCom Command—North American Command—in Philadelphia, the establishment of a fifth service branch to be headed by a four-star general who will then become the chief law enforcement officer of the nation. The attorney general will relinquish that title because it will be required. Obviously, if you’re militarizing law enforcement, you’re going to have a military officer as chief law enforcement officer of the nation.

And here’s what the Bush Administration has done: They haven’t got A yet, but they’ve already put in all of the B through Z. Now all they need is the A. The infrastructure is already in place and ready to go.

In the words of Ashcroft, the so-called secret court within the Department of Justice would be done away with and replaced with a new Office of Political Security, which can then act in complete secrecy. The attorney general would still nominally direct the Office of Political Security, and Rumsfeld has already stated that with the establishment of the Northcom Command in a post-*Posse Comitatus* environment, the Department of Defense would do away with its internal security division and then set up an expanded Office of State Security.

The Department of Defense would then become involved in domestic law enforcement and, more importantly, the ferreting out of all seditious elements. For instance, the control of the CILF Program (Civilian Inmate Labor Facility), which is now jointly under the control of FEMA and the Department of Justice. Then it

THE REAL TRUTH ABOUT THE DRUG WAR

by Michael Ruppert



"This is the man who cost CIA Director Deutch his guaranteed appointment as Secretary of Defense after confronting him at Locke High School with hard facts about CIA dealing drugs." (Dick Gregory)

Mike Ruppert was an Honors graduate of UCLA in Political Science; he comes from a family rooted in intelligence and the military. As an undergraduate he interned for Los Angeles Police Chief Ed Davis and worked at 5 LAPD Divisions before graduating and becoming an officer in 1973. During Mike's 5+ years of active service, he received thirteen citations and four commendations. Twice the CIA attempted to recruit Mike: the first time just before he graduated, and again after he was a highly praised field officer and budding narcotics investigator. In 1977 he discovered CIA bringing drugs into the U.S. through New Orleans in an operation supervised by his then fiancée, a CIA agent. He began to speak out and was forced out of LAPD in November 1978 after being shot at and threatened. He has been speaking out publicly ever since. In 1981 he spoke out about CIA and drugs inside the White House during a visit to his college classmate Craig Fuller. Fuller later served as Chief of Staff to Vice President Bush.

VHS video – 120 min.
\$19.95 (+S/H)
 Code: MRV (1.0 lb.)

SEE NEXT-TO-LAST PAGE FOR ORDERING OR CALL TOLL-FREE: 1-877-280-2866

MIND CONTROL: PARANOID DELUSIONS OR FRIGHTENING REALITY?

by Dr. Eldon Byrd

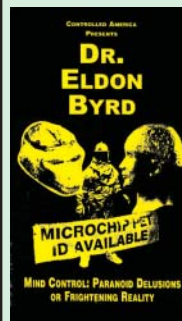

Byrd has a BS Electrical Engineering degree from Purdue and MS Medical Engineering from the George Washington University. Several of his work assignments were on Navy and Marine projects as TRIDENT, POLARIS ICBM, SALT I, Chief Engineer of the World Dolphin Research Foundation, U.S. Marine Corps Electromagnetic Non-lethal Weapons Development Project, Cryogenics Engineer, Project Manager of the Navy Metal Matrix Composites Program. He was a retired Naval officer. President of three corporations. Mentioned in the *American Men of Science*.

VHS video – 105 min.
\$19.95 (+S/H)
 Code: EBV (1.0 lb.)



OPERATION MIND CONTROL: THE CRYPTOCRACY'S PLAN TO PSYCHO-CIVILIZE YOU

by Walter Bowart

Walter Bowart is best known as the author of the best-selling 1970s classic *Operation Mind Control*, which even today, remains an authoritative guide to the intricate world of mind control. Delving deeper than just drugs or electroshock, Walter H. Bowart takes serious research a step further, into the Monarch mind-control program and the development and programming of multiple personalities for future secret actions including murder and terrorism.

That this research, in so many great halls of learning, has exceeded a cost of untold secret millions of dollars, indicates that this project being produced by our secret police is a matter of ambitious policy rather than the happenstance of cloak-and-dagger adventure.

To alter and control human minds is the ultimate anarchy. What is offered by official apologists as a tribute to the deeds of daring-do by romantic spies are acts of hatred and sadism against all people in an insane and degraded determination to extirpate conscience from society.

VHS video – 90 min.
\$19.95 (+S/H)
 Code: OMCV (1.0 lb.)

SEE NEXT-TO-LAST PAGE FOR ORDERING OR CALL TOLL-FREE: 1-877-280-2866

would be transferred to the Office of State Security and would be administered directly by the military.

But people are joking about it because the mainstream media has turned it into a joke ("Democrats holed up in a Holiday Inn"). It was Tom Delay's idea originally to have these people arrested and charged with sedition. When he made his comments that it was his God-given right to eliminate Democratic Party influence in Texas, and thus declare Texas the first sedition-free state in the union, he did it on purpose. In Delay's mind, Democrats are seditious by their very nature. And he's right—under the new interpretation of the laws previously mentioned. Being a Democrat or the opposition party, and acting to frustrate the will of the Supreme Leader, is seditious.

Anyone who attempts to impede or frustrate the will of the Leader of the New Imperial State is acting in a seditious capacity.

As it has been pointed out quite correctly, the Democrats are not an opposition party anymore in our new defacto One-Party State. No money equals no power. Therefore, the Democrats have become superfluous and they cannot meet the constitutional bar, as it were, to be an effective party in opposition.

And how does this relate to the history of the Roman Empire? The exact equivalent to what we have in this country today would be when Imperial Rome moved from Tiberius to Caligula, his grandson.

The United States is now entering the era of the "Twelve Caesars". On the flowchart of the Twelve Caesars, George Bush and Company represent the passage to Caligula from Tiberius.

The great emperors who had built Imperial Rome—Caesar Augustus, Caesar Hadrian, Caesar Tiberius—it was all destroyed under Caligula. Caligula had senior members of the Imperial Senate murdered and seized all power for himself, until he was assassinated himself. Then

Nero finished the job by making the emperor truly the emperor in terms of ruling by edict.

We know about Nero, but what about the Bushonian Cabal? What are their sexual proclivities?

Remember what Nero said: half my empire to be a woman. He wanted to be a woman so desperately that he would have given half his empire. The Caesars weren't just bi-sexual, homosexual, and transsexual. They were polymorphous.

And now in America, you have a politically popular president who's doing stupid and costly—but politically popular—things, with control of the media, which spins everything the right way, and with everyone waving the flag around.

Dr. Samuel Johnson said: "Patriotism is the last refuge of the scoundrel." But the Bushonian Cabal has even transcended that. Now patriotism is the last refuge of the would-be dictator.

Bushonomics Roils The Markets: Sucker Buying, Gold, And The Threat Of The Truth (5/27/03)

The latest scuttlebutt in Washington is that the time of the Silent Coup by the Bushonian Cabal has begun.

After his meeting with Philippine President Arroyo, Bush made a statement calling al-Qaeda a shadowy cabal that hides in dark corners plotting its envisioned havoc on the world's political, economic, and social order to impose its beliefs and values on the majority. It's time to cut off their money and bring them to justice.

After hearing this, I thought to myself: Couldn't the exact same thing be said about the Bushonian Cabal and their allies in the Religious Right?

If you substitute al-Qaeda for the Bushonian Cabal, you'd have something that would be closer to the truth. But you can't cut off their money because

they already have it all.

Then there was the interview with former Treasury Secretary Paul O'Neill, who's now working at the Blackstone Group. He told the truth and it cost him his job as a Treasury Secretary. He might end up working for twenty grand a year for some pro bono Democratic outfit. Wouldn't that be a comedown?

O'Neill said in an interview with CNBC that, thanks to Bushonomics, the nation has TRILLIONS of dollars in debt—off the books. The U.S. Treasury has no idea who we actually owe this money to. He points out the discrepancy between the number of U.S. Treasury bonds outstanding, and what the actual debt is. He said that there's a lot of debt out there, but nobody seems to know where it is, or to whom it's owed.

Ever since the 1980s the Republicans have used off-budget financing to hide debt. They accumulated TRILLIONS in debt through this smoke-and-mirrors accounting trick, and now nobody even knows where it is. This is the legacy of Bush Senior.

Bushonomics has built-in a time bomb, he said, for those being born today. It will make the Great Flood look like a spring rain. I was surprised at his candor, given the fact that he works for Blackstone. (See my book *The Conspirators: Secrets Of An Iran-Contra Insider* for more details about Blackstone Group frauds.)

They finally told Treasury Secretary Snow to keep his mouth shut, because every time he says something, the dollar gets hammered. That's the problem when you have a guy as Treasury Secretary who knows nothing about public finance. He doesn't even have a clue what he's saying. He doesn't understand the implications because he doesn't even understand what he's talking about.

The White House then came out with a statement saying: "Oh, no, we still have a strong dollar policy." This contradicted what Snow had said over the weekend. Snow said over the weekend that the dollar hadn't fallen very much. Catherine Yang, who was interviewing him, said something like: "Well, Mr. Secretary, the dollar has lost 30% of its value since the election of George Bush. What do you call 'a lot'?"

Ari Fleischer, Bush's press secretary, has also announced that he's resigning. He must have gotten fed up with lying all the time. But he'll do fine. Generally, press secretaries will end up with \$300,000 a year for life directorships at the Heritage Foundation or the American Enterprise Institute. But he'll never have to do anything because these Republican political patronage directorships are really about just getting the money and not really doing anything.

Revelations of a Mother Goddess **An Interview by David Icke**

The staggering story of human sacrifice and satanic ritual, involving the most famous people in the world.

Arizona Wilder, formerly Jennifer Greene, was mind-programmed from birth to become one of the three most important female conductors of Satanic rituals on the planet. Her programmer was Josef Mengele, the notorious "Angel of Death" in the Nazi concentration camps. When he died in the late 1980s, her programming began to break down.

In this video interview with David Icke, she describes human sacrifice rituals at

Glamis Castle and Balmoral, in which the Queen, the Queen Mother, and other members of the Royal Family sacrificed children in Satanic ceremonies.

She talks of the same experiences with Henry Kissinger, George Bush, Bill Clinton, members of the Rockefeller and Rothschild families, and a host of the most famous names in the United States and the United Kingdom.

Your view of the world will never be the same when you hear the revelations of Arizona Wilder and consider their relevance to your daily life.

SEE NEXT-TO-LAST PAGE FOR ORDERING OR CALL TOLL-FREE: 1-877-280-2866

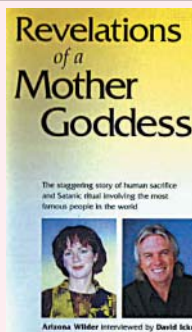

2-VIDEO Tape Set
OVER 4-Hours
\$39.95 (+S/H)
Code: RMG (1.5 lb.)

Ari Fleischer will join the ranks of the Bushonian Nomenklatura. He'll be taken care of for life as long as he keeps his mouth shut. Somebody's got to tell Bush that this isn't supposed to happen in a Capitalist State. But then Bush seems to have some confusion. His idea of "capitalism" is that only Bushonian Cabalists should have cradle-to-grave security. This is in the longstanding tradition of Bushonian Corporate Socialism.

And then the Wimping Out of Paul O'Neill happened. He was back on the commentary break on CNBC in the afternoon. O'Neill asked if he could come back and he did weave into the conversation that, in the interim since the interview of the morning, he said he had talked to the "Boss Man", as he calls him, the infamous sinister and dreaded Arch-Bushonian Cabalist Frank Carlucci, Republican Scamscaater Extraordinaire. (He's "retired" but he's still in control.)

Now that he got the word, O'Neill said that the dollar's decline isn't any problem and he sees that the White House and the Treasury Secretary are coordinating their statements on the dollar, and the dollar's decline is healthy for the economy, and he supports the Bushonian tax cuts. It was a complete wimp-out. Why do you think he mentioned that he had talked to the Boss Man? Everything had changed.

And that's what happens. You step out of line and you get a phone call from an Arch-Bushonian Cabalist who sets you back on the right path and who reminds you of your perks, benefits, pensions, inside stock tips, and encourages you back on the Path of Righteousness. And that's Righteousness—Bushonian Style. You'll reverse yourself in a hurry when you speak a little truth.

Then I saw an interview with a British psychiatrist who was commenting on the "growing wave of suicides" sweeping the "Euro Zone" in Europe and Japan as the world's economy continues to sink into the abyss. The American interviewer said that the suicide rate in the United States has also increased since the election of Gorge Bush, but by no means could it be considered a "wave". The British doctor responded by saying that, fortunately for you, Americans are too stupid to understand what is happening. After then, the interviewer didn't say anything. He didn't have any follow-up comment at all.

In other news, gold has skyrocketed \$10 in the regular session, and then, in the so-called third-market after-hour session, where there is normally light volume in gold trade, gold has continued to rise another \$3 (when it usually ordinarily only moves 20¢ or so). A gold trader I know said that it's "wild action" going on. What has propelled gold has been an enormous demand for physical

gold coming from shadowy Republican-controlled offshore gold bullion depository accounts. He also said that, in the same light, the same shadowy Smart Money Republican accounts have also been massively liquidating the dollar—particularly in the morning session. That's what caused the dollar to get hit so hard in the morning, before it floated back in the afternoon.

He also said that there is a genuine fear among the Smart Republican Money Crowd that there is a catalyst in all this, and the catalyst may be that this dollar decline may be unstoppable

The Bush Administration may not be able to stop it because they don't have the ability. The Treasury reserve funds are exhausted. The Federal Reserve Currency Stabilization Fund is exhausted.

What they would do is to start changing their comments for one thing—to try to "jawbone" some stability into the dollar by coming out and simply renouncing everything they have said before. They would have to say: "We stand behind a strong dollar—period."

The Bush Regime is trying to have it both ways. They want a strong dollar in order to act as a governor on inflation—although there is no inflation currently. As a matter of fact, we have the opposite problem. The Bush Regime knows that there is an enormous amount of incipient inflation that they have built up in the pipeline since the election of Junior, by ramping the money supply so much and by reducing the interest rates rather quickly.

This inflation hasn't been felt by the consumer because there is a counterbalancing weight against that inflation, namely the global debt deflation we are now experiencing.

What the Smart Republican Money is concerned about is that the dollar may act as some sort of tripwire and that the dollar's decline cannot be halted. The Bush Administration does not have the means to stop it. It has released so many conflicting statements that it has lost any credibility in terms of its ability to jawbone the dollar higher. In terms of concerted measures, the Bush Administration doesn't have any money to support the dollar because they've drawn down and misspent all of the Treasury's and Fed's "reserves" normally dedicated to supporting the dollar.

Evidently my comments on radio shows I've done have had some impact. He said there were comments on the CME floor about someone who had been writing recently about "missing gold" from the U.S. stockpiles. And I'm the only one I know who has been writing about it. And it's growing into a real rumor on the floor.

The Smart Republican Money (those who

have made TRILLIONS shorting the equity markets since the election of their Boy George and have consequently gotten out of those dollars, converted their profits into gold, and gotten that gold into offshore, non-taxable, non-attachable, and non-attackable jurisdictions) is afraid that the dollar could act as a tripwire and it could keep sinking so that eventually the American people may figure out what Bushonomics has done to this nation and to the global economy.

At that point, as this guy points out, there would most likely be a revolution in this country—or at the very least, a huge increase in civil unrest—if people ever figure out what Bushonomics is all about and what the Bushs have done. (Obviously outright revolution is no longer possible with the passage of the *U.S. Patriot* (sic) *Act* giving the Bushonian Regime dictatorial power to suppress internal dissent.)

He said that the Smart Republican Money Crowd, as in Glenbrook, Illinois, is having nightmares about barbed wire on top of their fences and in front of their homes, and being attacked by mobs—once people figure out what they have done and who's responsible. He said that is the dangerous part of the game of Bushonomics, and that the American people must not find out.

The American people know they've been scammed. They just don't understand by whom or how it was done. That's why they're so confused and depressed. If they ever figure it out, we're going to have one hell of a problem in this country.

I've said this on radio shows before: Look at the price of gold, and more importantly, look at the flow of gold—where it's going and who's buying it and how its being accumulated.

The traders on the floor know who the buyers are (but they can't tell you), and they know what the buyers are doing with it.

Last week, billionaires George Soros and Warren Buffett were interviewed. Soros essentially stated that he was short the U.S. dollar, and he is continuing to sell short the U.S. dollar and U.S. equities. It is his belief that Bushonomics is pressuring not only the U.S. economy, but the global economy, which is growing increasingly precarious. His view is that if Bushonomics is allowed to persist, he, George Soros, has absolutely no doubt that it will cause the eventual collapse of the world economy.

Buffett made some comments on the Bushonian "tax plan" in which he made comparisons between himself and his secretary. If the tax plan passes through the proposed House-Senate compromise, Buffett's tax rate would go down to 3%, while his secretary's taxes would increase from 28% to 30%—despite the fact that Buffett's income is 10,000 times greater.

After Buffett made those comments, on CNBC and FNN, they dragged out every Bushonian shill they could find. Steve Forbes called him an idiot and said that Buffett comes from a working-class background and he's not educated and he obviously doesn't understand tax issues.

All the Bushonian skills kept saying: don't listen to the self-made billionaires who made their billions by being short U.S. equity markets at the right time—i.e., during Bushonian Regimes. Therefore, they are first unpatriotic, and secondly not credible—despite the fact that this is how we, the Bushonian Cabalists, made our money.

Sucker Buyers: please help your favorite billionaire and buy more stocks.

Soros even mentioned how Republicans speak with forked tongues, and that he knew personally that the big deep offshore Republican-controlled short pools have been quietly taking in money from Bushonian-connected Republicans in the United States. He said they currently have more than \$400 billion sitting offshore waiting for the Final Last Uptick of the current bear market rally, as he put it, to jump on it. What they want to do is try to get their minions (the Larry Kudlows and Bill Seidmans of the world) to drum up every last retail sucker buyer they can.

But Soros won't come back to the United States now. He permanently lives in Europe despite the fact that he is a U.S. citizen. He says he keeps trying to tell the truth and warn the people about Bushonomics and what the Bushonian Cabal is doing to the country, denuding the people of their civil rights (something which Warren Buffett has also spoken about).

Soros is afraid of what might happen to him, that the Bushonian Regime may have something untoward planned for him. He said that the only thing the United States is good for anymore is to sell short everything that says "Made in the U.S.A." on it, and make all the money you can, and live comfortably somewhere else.

Last Monday afternoon (May 19) there was a period of time wherein almost \$58 BILLION in 34 minutes left the United States. There has been such a huge sudden demand by wealthy Republicans in the United States converting their dollars into gold and effectively hiding that gold in offshore, non-taxable, non-attachable, non-attackable, gold bullion depository receipt accounts.

What's suspicious is that when pressure on the dollar got relieved (when this transaction was over and when gold came back down after hitting that \$370.50 tick), twelve minutes later the nation's terrorist alert status was raised from yellow back to orange. This took the market off-guard

because there wasn't any warning of it as there had been previously.

What's caused additional fear and unsteadiness in the world's markets was that the Bush Administration did it very suddenly—unlike the last two times it raised the alert to orange when it clearly announced it in advance and clearly stated the reasons. They did this about 24 hours in advance the last two times.

Deputy Reichsfuehrer Ridge actually gave a speech to Congress saying that everything was fine. Then he goes to the White House, and 12 minutes after he gets there, they raise the terror alert from yellow to orange. Then they state there are "no specific reasons" for the terror alert. (Other than the requests by 3M to help increase now flagging sales of duct tape and plastic sheeting.)

The markets globally were roiled by this—by the way it was done—with no precursor, no warning, and no imminent threat. The Bush Administration didn't come out and say there were any domestic targets. Why raise it to orange when you have absolutely no proof that there is increased risk of terror attack? That immediately made people suspicious.

There is a growing feeling that something is coming. The growing nervousness in the global equity markets, the wild inter-day gyrations we're seeing in U.S. Treasury bonds, gold, and even oil to some extent. The enormous sudden amount of expatriation of dollars from wealthy Republicans outside the United States. The conversion of that money into gold.

Then suddenly the Department of Defense is very nervous. Suddenly the White House and Department of Justice is very nervous. Something has leaked out. Something they've done wrong has leaked out and they're frightened of it.

This might be a trigger or a catalyst that would simply be a level of truth about the Bushonian Cabal that would be unacceptable for the American people to know.

Since Sunday night, six former Democratic congressional investigators of the committees on Iran-Contra, IraqGate, BCCI, BNL, etc., have suddenly disappeared, and their current whereabouts are unknown. Their offices were looted and documents were shredded.

I've been making calls and people have left the country. People are in hiding. The Bush Administration, to prevent this truth from coming out, has instituted an operation to clean up its past. There is great angst

coming out of the White House, and those who know too much are the recipients.

The orange alert may be a precursor for a red alert. If they cannot prevent these truths from coming out, we may see another terrorist incident in the United States.

It would be a two-fold strategy: first, to deflect public and media attention, allowing them to get underneath the radar and to clean up all their problems; then, if the truth cannot be sufficiently discredited, then they could actually use this as an excuse to seize control. The signs are all there that something big is coming potentially. I think they're setting up the pretext, as it were.

Ridge said he wants any U.S. citizen, charged with any seditious behavior for publicly criticizing the Bushonian Regime during an orange alert, to not be allowed to board a U.S. commercial aircraft, no matter where the destination is. Further, they should not be allowed to board any train or bus that would cross an internal border.

I like that they're not even saying "state lines" anymore. Now the language is "internal border". Notice that just after Ridge and Ashcroft have a meeting with one of their Soviet "consultants", they start using the language of "internal borders" and "internal passports". The Soviet jargon is being revived.

If you add all these little factors up, you come up with the concept that there is a piece of truth out there that they can't control. It may have to do with the Huntsville Arsenal story and how weapons ended up in Iraq. Another more recent piece of it has to do with what happened to the \$2 billion in cash seized from Iraq, which is genuine yet will be declared counterfeit. There is a military connection in this thing. Some piece of truth has leaked out, and they're trying to control it.

First, your 401K account becomes a 201K account. Next you lose your pension and health plan. Then you're told to buy duct tape, plastic sheeting, and cans of Spam. This is the New Bushonian Learning Curve for the masses. 

"Medicine is not only a science; it is also an art. It does not consist of compounding pills and plasters; it deals with the very processes of life, which must be understood before they may be guided."

— Paracelsus (1493-1541, Swiss physician and alchemist)

The SPECTRUM Back Issues — Call toll-free: 1-877-280-2866

Vol. 1, #1 June 1999

Premier Issue • HATONN: Learning To Act In Oneness With All Of Creation • *Genocide With A Capital "G"*, Dr. Len Horowitz • Benzene And Other Poisons In Our Food Supply • Money & Secret Powers • New Menace Is Stalking Europe: It's The U.S. • What's Happening In Yugoslavia? • What Has Happened Since The CONTACT Lock-Out? • SOLTEC: Growth Comes From Understanding Of Truth, • EL MORYA: Recognizing Value In ALL Of Life's Challenges

Vol. 1, #2 July 1999

XEROX COPY

Healing Codes For The Biological Apocalypse Dr. Len Horowitz • SANANDA: It Is *Your* Life And *Your* Responsibility • Native American Perspectives: The Wisdom Of Rolling Thunder • *Untangling The Web*: Hidden History Paints Revealing Picture • SOLTEC: Making Good Use Of This "Quickening" Environment • SOLTEC: Watch The Clues, Both Near And Far • SANAT KUMARA: Will You Blossom Or Burn Out? • The "Soy Toxin Team" Story • SOLTEC: Turning Clues Into Wisdom Through Insight • SANANDA: True Abundance Comes From Walking The Spiritual Path • The Illuminati Millennium Rituals

Vol. 1, #3 August 1999

XEROX COPY

Are Their Aliens Among Us? *The Biggest Secret* David Icke • Native American Perspectives: Remembering Who We Are • SOLTEC: Each New Day Is A Miracle Of Opportunities • SOLTEC: Choices Are Central To The Creative Process • Have We Been Gifted With Waters To Heal A Sick Planet? • Data On The JFK, Jr. Crash • HATONN: Recognizing YOUR Purpose Helps The Larger Plan • Two Millennia Of Prophecy Collected Together

Vol. 1, #4 September 1999

Is Edgar Cayce Back? An Interview With David Wilcock • Native American Perspectives: The Native Ways And Teachings • "Better" Living Through Chemistry—Prozac: Panacea Or Pandora? • GERMAIN: The Power Of Truth In A World Of Lies • Oracle's Messages About Parasites • Introductory Essay On The Wilcock-Cayce-Ra Connection & The "Mission" • Some Excerpts From *Convergence* • SANANDA: Clear The Weeds From Your Wheat • As Planetary Frequency Upshifts, Are You Going Through "The Change"? • Waco And The New World Order: The Astonishing Connections • ATON: Recognize Your Vast Spiritual Heritage

Vol. 1, #5 October 1999

Great Zulu Shaman Credo Mutwa • SOLTEC: Navigating The Road Of Frequency Increase • Sunspot Cycles: Their Profound Effect On Man & Earth • Essiac: A Natural Herbal Cancer Therapy • SOLTEC: Geophysical Clues About These Times Of Cleansing • Plate Tectonics: A Lesson On Earth's Outer Structure • Native American Perspectives: The Women And The Chiefs • GERMAIN: Learn To Sense & Embrace Big Changes Coming Fast • HATONN: Discerning For Yourself The "Reality" Of Hatonn • Parasite Elimination: A Must For Good Health

Vol. 1, #6 November 1999

The Mayan Calendar • The Horse Whisperer: An Interview With Monty Roberts • Native American Perspectives: The Elders, Medicine People, And Warriors • SOLTEC: From The Caterpillar To The Butterfly • A Remarkable Glimpse Of Egyptian History • HATONN: On "Reptilian" Shape-Shifting And The Hatonn-Ra Connection • Magnets And Solar Panels

Vol. 1, #7 December 1999

An Interview With Robert Ghost Wolf • Native American Perspectives: Indian Prayers, Visions, and Native Ways • SANAT KUMARA: *You* Are The

Miracle You Are Searching For! • Red Tide: The Chinese Communist Targeting Of America • Blindness, Mad Cow Disease, And "Canola" Oil • EgyptAir Flight 990: Astonishing News The Media Hides • HATONN: Reach Out And Touch Someone • *Get Well!* How To Create Powerful Health • SOLTEC: We Are All *Both* Teacher And Student

Vol. 1, #8 January 2000

Dr. Len Horowitz's *Healing Celebration* Remedy • Harvard Speech By Charlton Heston: *Winning The Cultural War* • The Unnering Truth About Mind Control "Forewarned Is Forearmed" • RA: Knowing Our Karmic Past May Help Us Understand The Present • The Mechanism Behind An Upcoming Major Global Economic Crisis • HATONN: What Are Some Clues For Truly Finding *Your* Purpose? • On The Rev. Jesse Jackson And His Role In The Murder Of Dr. Martin Luther King, Jr., Part I • GERMAIN: Forgiveness Is The Key To Transformation • Prophecy: Warriors Of The Rainbow

Vol. 1, #9 February 2000

What If Everything You Thought You Knew About AIDS Was Wrong? Christine Maggiore • SOLTEC: Finding Your Natural State Of Inner Energy Balance • Colloidal Silver Healing Legacy • Big Brother Internet: Nameless & Faceless In Cyberspace • Remember To Look At The View • Native American Perspectives: Facing Our Destiny • HILARION: Letting Grow By Letting Go • When Disclosure Serves Secrecy

Vol. 1, #10 March 2000

Indigo Children: An Interview With Jan Tober • Purposeful Con-fusion Surrounding Cold Fusion • Vaccination: An UnGodly Practice, Dr. Len Horowitz • The Ritalin Generation: Drugging America's Youth • MSG: The Deadly Mouth Aphrodisiac • Native American Perspectives: Toward Sovereign Indian Nations • SOLTEC/HATONN: Glimpses Of The Truth Behind Your Shadow World • A Fancy Trail Of Money Laundering By Greenspan, Bush & The Twiglets

Vol. 1, #11 April 2000

Sound Healing: An Interview with Jonathan Goldman • Legal Help When Laws Go Wild: *Justice Team One* • The Lever That Moves The World • So You Want To Plant A Garden? • Silverlon®: Medical Applications • Money Laundering Part II: Introducing Still More Crooks • SOLTEC: That "Secret" Something We All Are Searching For • HILARION: Understanding Your Bio-Electric Sensing Machine

Vol. 1, #12 May 2000

XEROX COPY

The Most Powerful Man In The World? The "Black" Pope • Vatican Bank Sued For Alleged War Crimes • GERMAIN & SANANDA: The Time Has Come To Awaken From Your Dream! • Does Elian Gonzales Case Bring Out The "Best" In Clinton's Criminal Regime? • The "Bio-Electrical Cleansing" Research Of Dr. Robert Beck • Sacred White Buffalo Murdered

Vol. 2, #1 June 2000

A Talk With The Ishaya Monks: Powerful, Ancient Teaching Held For This Historic Cycle • HATONN: Staying The Course Despite

Rough Seas • The Curious Case Of Dave Overton's Gold And The Phoenix Institute • Chemtrails: Did An Airline Mechanic Stumble Upon The Truth? "Project Cloverleaf" • SOLTEC: Learn To Balance In The "Now" • Exposing The Truth About "Holy" Sathya Sai Baba

Vol. 2, #2 July 2000

Ticking Time-Bomb *Prozac* • SOLTEC: Are You Ready For All That May Cross Your Path? • Revealing Article About Phoenix Institute Directors: Paying Back *What* Debt? • Are Fed & Treasury Manipulating Gold For Gain Of Few? • Most Profitable Industry In America? Our Prison Systems! • "The Boys" Of Chicago: Law Bought & Sold For Bargain Prices • More Information About Chemtrails Mystery "Poison Cobwebs From Hell" • SANANDA: I Hear Your Call, Do You Hear Mine? • American Death Camps

Vol. 2, #3 August 2000

Ramtha's School Of "Enlightenment"? • Full-Page USA TODAY Ad On Illegality Of Income Tax • FDA Boosts PMS Insanity With Prozac In Disguise • HATONN: Compassion Along The Lighted Path Of Creation • FDA-Postal Raid On "The Phoenix Group" • HAARP's Covert Agendas • SOLTEC: Breaking The Grip Of Often Subtle Mind-Control • How The Sheep Are Led: A "Pretend" Speech On Population Reduction

Vol. 2, #4 September 2000

FEMA: Bizarre Wildfires Expose Sinister Agenda • GERMAIN: Remaining Flexible In These Times Of Great Change • Fishy CIA Link To Malathion Spraying For West Nile Virus • Killer Music: Mind Control's Subtle Drug • With No Obligation To Educate, Schools Turn To Thought Control • HATONN: How To Make This Cleansing Cycle Work For You • Robert Ghost Wolf, *Beyond The Veil: Visions For A New World*

Vol. 2, #5 October 2000

Montauk Project's Wild Ride Through History • CAFRs: The \$60 Trillion Secret • SOLTEC: Awakening To The Miracle • Stop Ritalin! 2.5 Million Children Across The Nation Are Given "Cocaine" By Their Parents And Doctors • The Homosexual Agenda That Is Invading Our Schools • HATONN: On Health, Helping, And World Politics • Update On FEMA Report • Tavistock: The Best Kept Secret In America • Does "Global Governance" By UN Really Mean "One World Order"? • GERMAIN: You Can Accomplish Great Things With Your "God Power"

SPECTRUM SPRING CLEANING SPECIAL!

It's springtime and we need to clean out the old to make room for the new — LUCKY YOU!

While they last*, ALL back issues of *The SPECTRUM* — from June 1999 (our very first "Premier" issue) until December 2001 — are ONLY \$2.00 each, and that includes postage! These are all in newspaper format. Get them while you can — they won't last long!

Credit Card orders, call toll-free: 1(877)-280-2866

Mail Orders, send Check or Money Order to:

The SPECTRUM
PO BOX 1567
Tehachapi CA 93581

Be sure to specify the exact issues you want.

(*This offer does NOT include out-of-print issues — Vol. 1, #s 2, 3, & 12)

Vol. 2, #6 November 2000

"The Call Compels The Answer" Angels Stand Ready To Help • Doctors *Vote To Oppose* Mandatory Vaccinations • SPECTRUM Staff On The Air • SOLTEC: Breaking Loose From Those Limiting Beliefs • Coca-Cola/CIA/Tribune Drama In Federal Chicago Courts • History Of Secret Human Biological Experiments • An Overview Of The Illuminati • HATONN: Be Thankful For Your Planet's Great Gift Of Compassion

Vol. 2, #7 December 2000

For Peace On Earth: Work *With* The Angels: Doreen Virtue • SOLTEC: Expressing Yourself More Fully On Creator's Living Canvas • The Cure-All: Chaparral • SANANDA: At This Holiday Season Awaken The Gift Of Your God-self Within • Daring Journalists Victorious In FOX News Censorship Case • David Icke's Journey: A First-Person Account • *Do You Smell A Set-Up?* Cool Calculation Behind Ongoing Election Brawl • HATONN: A Nation's Destiny In A Time Of Awakening

Vol. 2, #8 January 2001

Montauk & Philadelphia Experiments: "Back To The Future" A New Interview With Al Bielek • *The Eighth Thunder*: The War Of Valued Life • HATONN: The Play Is Moving Toward A Grand Awakening • SANANDA: With Understanding Comes The Wisdom To Release Fear And Pain • "Mercy" Killings And The Culling Of The Elderly • Some Well-Hidden Hazards Of Microwave Cooking • SOLTEC: Look Within And Tap The Awesome Power Of ONE • Election Intrigues To Think About

Vol. 2, #9 February 2001

Will The Lights Go Out In California And The Nation? *Expert Exposes Fraud & Greed* • "When You Don't Know What You're Doing, Do It Neatly!" • The News Desk • Connections & Revelations The Media Won't Touch • Dean Kamen: Gifted Inventor And Man Of Mystery • SOLTEC: Satisfaction Means Balancing The Inner And Outer Worlds • *A Call For World Peace*: A Message From Great White Buffalo • SANAT KUMARA: To Know Yourself, Reach Out To Others

Vol. 2, #10 March 2001

Rediscovering Ancient Truths About The Spiritual Side Of Science: Heart And Head *Must* Work Together • The Power Of Those Who Stand-Up For Truth • SOLTEC: Stand And Be Counted For A Better World • Pasadena Health Show: A Great Success! • Anna Detweiler: Seeing Truth Beyond The Shadows • Skolnick's Revelations About Current Events • SOLTEC: Lose The Baggage And Free Your Mind • HATONN: The Physical Experience Is For *Spiritual* Growth

Vol. 2, #11 April 2001

Will Healthy Agriculture Survive Big Business? Organic Gardening—Power Of The Soil • What Would We Do If There Was No Food? • Skolnick's Report On Crooks In High Places • England "Bombs" Gold Prices • SOLTEC: Go With The Flow Of Your High-Frequency World • Hopi Elder Chief Dan Evehema's *Message To Mankind* • California's Power Crisis: A Most Revealing Update • SANANDA: What's Truly Important In Your Life? • Farming Ourselves Into Oblivion: Small Sustainable Farms Are Our Greatest Hope Against A Faceless Agriculture • So You Want To Plant A Garden?

Vol. 2, #12 May 2001

What Can We Do About Science Gone Mad? HAARP & Other High-Tech Insults • You Just Never Know What May Cross Our Desk • Some Useful Background Material On HAARP • SOLTEC: Dealing With Inner Stirrings Of Unrest • China Incident: Technology Transfer "It's All About Money" • Timing Signposts And A Message From The Hopi Elders • Zulu Shaman & Elder Credo Mutwa's Plea To The Global Elite: *Stop The Genocide In Africa!* • California Power Crisis Update The Extortion Of California: The Wrath Of Bush And

WTC & Pentagon, by Anita E. Belle, Attorney • Why Government Has Repeatedly Created War, by Christopher Ruby • Mark Twain's *The War Prayer* • Boy In Dallas Suburb Predicts Start Of WW-III Day Before Attacks) • A Hopi Elder Speaks • SANANDA: The Good Shall Be Sorted From Evil • KORTON: Communication Is *The* Key To Breaking The Spell • SOLTEC: The Nature Of The "Beast" And The Game It Plays

Vol. 3, #6 November 2001

The Great UFO Cover-up Is *Falling Apart* • A Time To Be Thankful • The War Against Terrorism Is A Fraud • SOLTEC: The "Trump Card" Of Divine Knowing • HOROWITZ: Preparing For Biological And Chemical Terrorism • New Visions From Anna Detweiler • EUSTACE MULLINS: Dust To Dust, Or: New Physics Is As American As Apple Pie • Electronically Hijacking The World Trade Center Attack Aircraft • SANANDA: Be Strong And Know That Help Is Near • The Great Coup, Or: What Price, Freedom? • Media Accomplices To 9/11 Crime Deserve Indictment • I Tried To Be Patriotic, Or: New Physics For 21st Century • KORTON: Pay Attention To Your Other Senses • Recent Interview With Osama Bin Laden • AL MARTIN: "Citizen, Can I See Your ID?" • SKOLNICK: The Overthrow Of The American Republic • More Potent Reasons For Destroying WTC

Vol. 3, #7 December 2001

Longtime Extraterrestrial Influences On Earth's Evolution, Conversations With Robert O. Dean • A Season Of Hope • A Christmas Blessing From *The SPECTRUM* • The Lightships • HILARION: Are You Losing Your Mind, Or Gaining Your Soul? • EUSTACE MULLINS: The Biggest Heist In History • SANANDA: The Shackles Shall Be Unlocked! • AL MARTIN: Hail The New Imperial Republic And Return Of The American Caesars • CHARLEY REESE: How To Control People • South Tower Burning BEFORE Jet Hits It • Microchip Implants, Mind Control & Cybernetics • COL. DE GRAND PRÉ: The Enemy Is Inside The Gates • HATONN: Time To Tune-Up Your Inner Radio

*** NEW MAGAZINE FORMAT ***

Vol. 3, #8 January 2002

The CIA's Role In The Anthrax Mailings • A New Year's Surprise! • EUSTACE MULLINS: The Reign Of Terror • The Rules For Being Human • SOLTEC: Listening Within And Thinking For Yourself • SANANDA: Do Unto Others As You Would Have Others Do Unto You—For Time Is Up! • SKOLNICK: The Enron Black Magic • Microchips & Abductees, Reptilians, Greys & Africa, Ancestors & ET Archaeology—The Great UFO Coverup, Part 3 • AL MARTIN: The "War On Terrorism" Scam Is FAU. (Fraud As Usual) • HATONN: Why War, Violence, And Anger At This Time? • Is Your TV Spying On You? What About Your Phone?

Vol. 3, #9 Feb/March 2002

A Skeleton Key To The Gemstone File: Hidden History Shocks A Nation • Onward And Upward • EUSTACE MULLINS: Profile Of A Terrorist: The Harvard President Of Mass Murder • SOLTEC: Desire Truth And Question Everything • Cracks Growing *Everywhere* In The Mirrors Of Deception: Full UFO Disclosure Breaking Thru—The Great UFO Cover-up Is *Falling Apart*: We Are Definitely NOT Alone! Part 4, The Final Chapter? • HATONN: Confirming The Inner Journey Of The Soul • SKOLNICK: Dirty Oil Pipeline Plots & More Enron Secrets • AL MARTIN: "Yabba Dabba Doo" Or, Clueless In Afghanistan

Vol. 3, #10 April 2002

Red Elk's Medicine Message Of Worlds Within Worlds • A Matter Of Conscience • EUSTACE MULLINS: A Book Review of *Vatican Assassins*: "Wounded In The House Of My Friends" • SOLTEC: The Natural Cycles Of Creative Expression • SKOLNICK: Bullies And Greed Shaping Our

The Texas Power Cabal • Skolnick's Scoop On Some *REAL* News • HATONN: How To Handle Psychic Attacks

Vol. 3, #1 June 2001

Merging Science With Spirit—The Isaiah Effect—Lost Wisdom Of Forgotten Peoples • Happy Second Anniversary! • SOLTEC: Learning To *Allow* For Your Growth • Clearance Sale On High-Tech Weapons: Inside The Weekly Arms Bazaar At Redstone Arsenal • Revisiting The Diabolical Oklahoma City "Bombing" • Idaho Standoff: Exposing A Peculiar Land-Grab Scam • Skolnick's Latest Updates Not For The Weakhearted • SANANDA: Aligning Heart & Head Are Key To A Satisfying Life • HATONN: Thanks To *The SPECTRUM* Staff And Supporters

Vol. 3, #2 July 2001

Maniacal World Control Thru *The Jesuit Order* Well-Hidden Soldiers Of Satan • Un-learning The Baloney And *Then* Learning The Truth • SOLTEC: Stresses And Pressures Are Catalysts For Growth • Dr. Len Horowitz On AIDS In Africa: "Utilitarian Global Genocide" • HATONN: Powerful Positive Forces At Work In Our Lives • More Revelations About Peculiar Idaho Standoff • Skolnick's News On McVeigh And Levy

Vol. 3, #3 August 2001

Breakthrough Science Confirms *The HeartMath* Message: Your Heart Has A Mind Of Its Own! • The Ticking Time-Bomb For A Better World • *The Jesuit Order* Corrections • HATONN: Subtle Winds Of Change Stirring Within Us All • Something's Up In The Banking & Monetary World • SOLTEC: Actively Seeking An Inner State Of Peace • BRADEN: Unlocking The Secret Of Heaven Through The Science Of Man • Skolnick's News On The FBI, *Washington Post*, And Airline Sabotage.

Vol. 3, #4 September 2001

Let's Re-Create Prison Into Paradise! *Check-Mating Globalization* David Icke Exposes What Elite Fear Most • A Visit With Mark Twain • Hilarion: Clean-Out Those "Closets" To Make Way For The New! • The Revolutionary World Of Free Energy: A Status Report • HATONN: Powerful Messages Can Appear In Many Forms • SANANDA: "The Voice Of Truth Shall Be Heard Throughout The Land" • More Skolnick On Airplane Sabotage And Chandra Levy • Recent Visions From Anna Detweiler

Vol. 3, #5 October 2001

The Day The Earth *Stood Still*: New World Order Thru "Terrorism" • Mail Delivery Slowed Due To Attacks • GERMAIN: "You Shall Reap What You Sow" • (INDEX OF FRONT-PAGE STORY: September 11, 2001—Chronology Of Terror • Alice In Wonderland And The WTC Disaster, by David Icke • How It Is Possible To Orchestrate And Mastermind A Terrorist Attack Without The Terrorists Themselves Even Knowing Who Is Really Behind It? by David Icke • Terrorism Prevention And Treatment Starts With Accurate Diagnosis, by Dr. Len Horowitz • Who Created Islamic Extremism? by Barry Chamish • Who Is Osama Bin Laden? by Michel Chossudovsky • U.S. State Department Sponsors Training Of Would-Be Terrorists, by Al Martin • What LaRouche Says In Radio Interviews, by Lyndon LaRouche • "The Enemy Is Very Much Within" • The Terror In America, by Eustace Mullins • Eric Phelps On Jesuit Behind-The-Scenes Involvement In Attacks • Explosives Planted In Towers, New Mexico Tech Expert Says • Fire, Not Extra Explosives, Doomed Buildings, Expert Says • The Split-Second Error: Exposing The WTC Bomb Plot, by Fintan Dunne • White Knights, Black Ops, And A New Money System, by "Dove Of Oneness" • Revealing Interviews With Al Bielek: Truth Stranger Than Fiction • Swiss Political Assassinations Meant To Deter NESARA, by "Dove Of Oneness" • Self-Inflicted: "Terrorist" Attack On

History • SANANDA: The Role *You* Play In Healing A Planet • AL MARTIN: Big Brother's Spying Robot Drones, The Flying Restroom Police, And The New World Order Neighborhood • CONGRESSMAN RON PAUL: Our Fraudulent Monetary System • World Bank & IMF Top-Secret Agreements Exposed On Radio: George W. Bush & Enron Share Center Stage

Vol. 3, #11 May 2002

SEEDS OF FIRE: China And The Story Behind The Attack On America Gordon Thomas On World Events • Sidebar—On The Challenges Of Sharing THE TRUTH: Conversation With Carol Adler, Publisher Of *Seeds Of Fire* • Spring Cleaning Time • The Flights Of The 9/11 Bumble Planes • SOLTEC: The Great Spiritual Battle Is Now In High Gear • The International Banksters' Fraud Perpetrated On All Americans (And Every Lawyer's Secret Oath) • SKOLNICK: Wal-Mart & The Red Chinese Secret Police • HATONN: War And Terrorism—Or, Is It A "Healing Crisis"? • AL MARTIN: Modern Roman "Stamp" Of Power

Vol. 3, #12 June 2002

Bright Path To Good Health: Full-Spectrum Light, The Sun Is *Really* Your Friend! • The Power Of Light • EUSTACE MULLINS: AMERICA'S PERIL—The Israeli "Fifth Column" Operating In The United States • SANANDA: Testing And Sorting In These Final Hours • Congressman Dr. Ron Paul: "Bad Boy" To Good Ol' Boys • SOLTEC: It's Always Darkest Before The Dawn • What Happened To One Inventor When His Device Delivered Over 100 Miles Per Gallon Of Gas • CALVIN BURGIN: Does Israel Have A Right To Palestine? Popular Fiction Is *NOT* Historical Truth • SIDEBAR: Mystery Of Dead Sea Scroll Unravels • HATONN: The "Psychic Internet" Is As Close As Your Thoughts • AL MARTIN: The Case For Sedition By The Bush Cabal

Vol. 4, #1 July 2002

The *TRUE* State Of The Union: Bush's "Axis Of Evil" Actually Right Here At Home! When Will We Realize That The Emperor Wears No Clothes? • Great Milestones To Note • EUSTACE MULLINS: *Murder By Injection: The Story Of The Medical Conspiracy Against America* • KATHRYN A. SERKES: More Legislation For Tyranny: *Model Emergency Health Powers Act* • Dr. Len Horowitz Blasts Mandatory Smallpox Vaccinations • HATONN: For "They" To Control, We Must Allow • DAVID MCGOWAN: America Through The Looking Glass • SOLTEC: Appreciating The Larger View Of Mother Earth's Cleansing • AL MARTIN: Latest Bumper Crop Of Government Scams • SKOLNICK: Little Known Facts About The Chandra Levy Affair • GORDON THOMAS: 9/11 & Mossad Warnings: Could U.S. Intelligence Failure To Act Be Because Mossad Was Prime Warnings Source? • KAY LEE: Hollywood And The Legislator

Vol. 4, #2 August 2002

Spiritual Warfare In America—Nuclear, Chemical, And Biological Peril: Interviews With Experts Steve Quayle And Dr. Len Horowitz • "You Know, I Used To Read *The SPECTRUM*. Now I Study It." • DR. STEVEN GREER: Cosmic Deception: Let The Citizen Beware! • GERMAIN: The Results Of Fear—You Have *Exactly* What You Have Created • DR. ALBERTO RIVERA: Secret Vatican Briefings On The Creation Of Prophet Muhammad • ERIC JON PHELPS: Example Of The Power Behind The Power • STARHAWK: The Boy Who Kissed The Soldier: Balata Camp—A First-Person Account Of Israeli Terrorism • HATONN: Allow Your *True* Self To Shine Through • SHERMAN SKOLNICK: Patterns For Looting The Average American's Wealth • History And Meaning Of *The Pledge Of Allegiance* • AL MARTIN: Raining "War" Dollars, The Golfcart Gestapo, And Bush's Con Game

Vol. 4, #3 September 2002

"An American Treasure" Eustace Mullins: Soldier Of Truth In A Lifelong Battle With Lies • The Awakening Power Of Examples • HATONN: Align Your Energies And Really Make A Difference • THE CHINESE CONNECTION: Powerful

Hidden Reasons Why DOJ Conspired To Get Rep. James A. Traficant • Trouble With Tankers: Chemtrails Campaign Adds To Air Force Woes • A TIMELINE FOR SEPTEMBER 11: If U.S. Government Wasn't Involved In 9/11 Attacks, What Were They Doing? • Congressman Dr. Ron Paul: Are We Doomed To Be A Police State? • SANANDA: Own Your Feelings And You Will Control Your Destiny • AL MARTIN: Our Sinking Economic Ship And Related Crooked Crises • Bombing The Mind: The Pentagon's Psycho-Drug Warfare Program • SHERMAN SKOLNICK: Blue-Blood Crooks And Their Sucker Traps

Vol. 4, #4 October 2002

The *Fork* In The Road: Fascism Or Freedom? David Icke Talks On: *Alice In Wonderland And The World Trade Center Disaster* • "Food" For Thought • The Children Of Crystal Vibration • EUSTACE MULLINS: Bush Boasts Strikes Against *60 Nations* In "War On Terrorism" • SANANDA & GERMAIN: Looking For Answers In All The Wrong Places • EUSTACE MULLINS: S.I.N. City's War Party Pushes Attack On Iraq • Hidden NWO Connections Between Rumsfeld, Aspartame & Sudden Death • AL MARTIN: Bush's "Comedy" Act Hurts Al's Commie Cat • HATONN: How Have *YOU* Responded To The 9/11 Wake-Up Call? • So Many Faces Worn By Same Evil • SHERMAN SKOLNICK: Big Secrets And Even Bigger Shysters • CHRISTOPHER BOLLYN: New Seismic Data Refutes Official Explanation For WTC Collapse

Vol. 4, #5 November 2002

Secret Rulers Of Planet Earth: The ILLUMINATI, Will They Melt Under Light Of Exposure? • When The Lights Go On • DR. LEN HOROWITZ: Smallpox & Anthrax Frights Planned *YEARS* Before 9/11 By Government & Drug Industry • The Last Defender Of The American Republic? An Interview With Gore Vidal • SOLTEC: Opening The Door To Truth • EUSTACE MULLINS: The Secret Of 9/11: The Drumbeat For War • Former U.S.A.G. Ramsey Clark Vocal Against War With Iraq: Letter To United Nations Secretary General • AL MARTIN: "Patriots" Needed To Staff Bush's Lie Coordination Bureau • DIANE HARVEY: Turn Yourself In And Get It Over With! • SHERMAN SKOLNICK: Will The *REAL* Truth Please Stand Up! • SANANDA: Actions Always Reveal Your True Level Of Growth

Vol. 4, #6 December 2002

A "Mother Goddess" Speaks On Illuminati Satanic Ritual: Mind-Control Slavery's Dark Secret • Déjà Vu Of What's To Come • EUSTACE MULLINS: Bush's "Call To War" Finally Made Public On Friday The 13th • Sen. Paul Wellstone: Revealing Reactions To A Tragic Death • DR. LEN HOROWITZ: The American Red Double-Cross • Happy Holiday Wishes From *The SPECTRUM* • SOLTEC: What Is *Your* Role In Mother Earth's Return To Balance? • Skull & Bones: The Racist Nightmare At Yale • DIANE HARVEY: The Boulder-Pushers, Or: Teachers In The Trenches • AL MARTIN: Valium Spray & Prozac Water To Keep Americans "Happy" • EUSTACE MULLINS: The Face Of The Enemy Exposed By Their Media • SHERMAN SKOLNICK: Blackmail Makes The World Go 'Round • HATONN: Awakening To Your Inner Journey

Vol. 4, #7 January 2003

Spirited Life Of The Peaceful Warrior: It's All In The *Doing* • The Peppermint Pattie Effect • DR. LEN HOROWITZ: Homeland Security Bill's "License To Kill" • SKOLNICK: Small Liars Behind Large Treasons • SANANDA: Make Room In Your Life For Your New World • *The Enemy Within* by Gore Vidal • Dr. Albert D. Pastore: Stranger Than Fiction: Documented Probe Of 9/11 & The "War On Terrorism" • AL MARTIN: Watch Out, Baby, 'Cuz Here Comes Reality! • HATONN: Recognize The Subtle Energies That Influence Your Life

Vol. 4, #8 February 2003

The War On Freedom: Jim Marrs' Wake-Up Call To Overcome *Rule By Secrecy* • "One Is Taken, One Left" • XYLLITOL: Our Sweet Salvation? • EUSTACE MULLINS: The Bush Boys' Bully Days Versus The Passion Of Jesus Christ • A New

Year's Message From ARCHANGEL MICHAEL • The View From Marrs—The War On Terrorism: Fact Or Fiction? • SANANDA: Is It Nearing "Showdown Time" On Planet Earth? • SHERMAN SKOLNICK: Fake Money's Role In Swindle Politics • AL MARTIN: Will Lunacy Become The National Illness?

Vol. 4, #9 March 2003

Is 2003 *Actually* 2012? Star Gates & Time Wars *Real* Reasons For Invading Iraq! • Real Miracle Behind Saddam's "Weapons Of Mass Destruction" • Space Shuttle Columbia Disaster: Clear Message In Open Sky • ARCHANGEL MICHAEL: Understand Who Are The Host Of God • EUSTACE MULLINS: A Philosophy For The Twenty-First Century • A Message From Red Elk • The Genesis World Energy Project: Is A Grand New Era Dawning? • AL MARTIN: These Days, Who ISN'T An "Enemy Of The State"? • SHERMAN SKOLNICK: Cracks In The Wall Of Lies

Vol. 4, #10 April 2003

Führer Ashcroft's *Patriot Act II* Shreds America's Soul: Public Exposure Only Antidote • Ben & Jerry's Ice Cream Founder Collides With Media Fraud • EUSTACE MULLINS: Phony Wars For Phony Peace: The Ministry Of Fear • Eustace Mullins Trapped In Extended-Care Facility Awaiting Wheels Of Justice • GRACE HALSEL: Armageddon: Zionism's Diabolical Goal • ARCHANGEL GABRIEL: Stubborn Bugs Meet The Cosmic Carwash • Former U.S.A.G. Ramsey Clark *Again* Blasts War With Iraq • AL MARTIN: Bushonomics Inspires America's New Spirit Of Middle-Class Crime • SIMONE GABBAY: What Are We Doing To Our Food? • SHERMAN SKOLNICK: Politics And Protests Swirl Around "America's Hitler"

Vol. 4, #11 May 2003

Our *Busy* Solar System: What Is NASA Hiding? Get Ready For What's Coming! • The Universe Is Knocking At Our Door • Dalai Lama's Views On War And Iraq Conflict • EASTACE MULLINS: Assault On Iraq: Prelude To World War III • SEN. ROBERT BYRD: "Where Are We Taking The World"? • DR. LEN HOROWITZ: Severe Acute Respiratory Syndrome (SARS): A Great Global *Scam!* • GERMAIN: What Has Become Of The Grand Freedom Experiment Called The United States? • AL MARTIN: The Prozac Nation & Its "Robot" Leader • Michael Moore Triumphs At Academy Awards • GORDON THOMAS: When The War Is Over, The *Real* War Begins • SHERMAN SKOLNICK: The French Connection, Black Slavery, And "Fragging"

Vol. 4, #12 June 2003

Operation American Freedom We *Must* Restore God's Precious Gift! • Freedom Begins In The Mind • Looting Iraq Of Priceless "Weapons Of Mass Destruction" • GREG PALAST: California Reamin': California And The Power Pirates • SOLTEC/TESLA: "And The Walls Come Tumblin' Down" • Message From The Hopi—People Of Peace • ROBERT FISK: For Iraqis—No Liberation, A New Colonial Oppression • What If Al Martin Were A Regular On National Radio? • SHERMAN SKOLNICK: Follow The Money For History Lessons

**Back Issues of
The SPECTRUM:**
\$5.00 each for the U.S.
\$7.00 each for Canada
\$8.50 each for Foreign

Also available on CD-ROM, the 1st, 2nd & 3rd full years are in searchable PDF format.

Price \$45 each

To order Back Issues or CD-ROMs please call toll-free: 1-877-280-2866
outside US please call: 1-661-823-9696

Name: _____ Date: _____
 Address: _____
 City•State•Zip: _____
 Country: _____ Phone: _____
 Credit Card #: _____ Exp. Date: ____/____/____
 Signature: _____

For faster, more personalized service when placing your order by credit card, money order, or personal check, please call us, TOLL-FREE, at:

1-877-280-2866

That's right—you can call-in your order, and still pay by check; order will be shipped upon receipt of check. Please have your order form filled out and your credit card or check number ready when you call to place your order. Ordering by phone rather than mail allows us to answer any questions you may have about the merchandise, figure the shipping for you, and alert you to any sale items.

Item Code	Qty.	Description: Please specify title, audio tape, video tape or CD-Rom	Unit Weight	Unit Price	Total Weight	Total Price

Total Order Weight: _____
 Total Order Price: _____
 CA & NV add 7.25% sales tax: _____
 Shipping/handling (See charts): _____
TOTAL: _____

Prices subject to change without notice.
All sales are final.

~ OTHER RATES ~

United States: Add \$5.50 (bookrate) for each **Vatican Assassins** or use the shipping and handling chart to the left for Priority mail.
Canada: (Airmail) \$8 for the 1st item; \$5 each for ea. add'l item.
 *Please add **\$13.50** for each **Vatican Assassins** ordered.
International: (Airmail) \$17 for the 1st item; \$6 for ea. add'l item.
 *Please add **\$31.00** (Airmail) or **\$25** (Surface) for each **Vatican Assassins**.

SHIPPING & HANDLING CHART						
Total Weight (pounds)	Zones 1, 2, & 3	Zone 4	Zone 5	Zone 6	Zone 7	Zone 8
0 - 2.50	\$6.00	\$6.00	\$6.00	\$6.00	\$6.00	\$6.00
2.51 - 3	\$6.90	\$8.20	\$9.00	\$9.30	\$10.00	\$10.90
3.01 - 4	\$7.45	\$9.20	\$10.20	\$10.65	\$11.60	\$12.50
4.01 - 5	\$8.00	\$10.15	\$11.45	\$12.00	\$13.15	\$14.30
5.01 - 6	\$8.45	\$11.00	\$12.05	\$12.20	\$13.45	\$14.45
6.01 - 7	\$8.95	\$11.95	\$12.80	\$13.15	\$14.70	\$16.20
7.01 - 8	\$9.50	\$12.90	\$13.60	\$14.10	\$15.95	\$17.90
8.01 - 9	\$10.05	\$13.85	\$14.35	\$15.05	\$17.20	\$19.60
9.01 - 10*	\$10.55	\$14.75	\$15.15	\$16.15	\$18.45	\$21.35

*Over 10 lbs. please call for shipping rate.

To determine your zone, look up the **FIRST** three digits of your ZIP code in the chart below:

ZIP Code Prefix	Zone	ZIP Code Prefix	Zone	ZIP Code Prefix	Zone	ZIP Code Prefix	Zone	ZIP Code Prefix	Zone	ZIP Code Prefix	Zone	ZIP Code Prefix	Zone	ZIP Code Prefix	Zone	ZIP Code Prefix	Zone
005-098	8	380-384	7	474-479	7	534-535	7	622-639	7	716-717	7	797-812	5	870-872	5	936-938	2
100-212	8	385	8	480-489	8	537-559	7	640-642	6	718-719	6	813-815	4	873-874	4	939-954	3
214-268	8	386-397	7	490-491	7	560-562	6	644-649	6	720-725	7	816	5	875	5	955	4
270-342	8	398-399	8	492	8	563-564	7	650-653	7	726-731	6	820-831	5	877-885	5	956-958	3
344	8	400-402	7	493-495	7	565	6	654-658	6	733-738	6	832-834	4	889-891	3	959-961	4
346-347	8	403-418	8	496-497	8	566	7	660-676	6	739	5	835	5	893	4	962-966	3
349	8	420-424	7	498-499	7	567	6	677-679	5	740-741	6	836-837	4	894-895	4	967-969	8
350-352	7	425-426	8	500-503	6	570-576	6	680-681	6	743-768	6	838	5	897-898	4	970-974	5
354-359	7	427	7	504	7	577	5	683-689	6	769	5	840-847	4	900-908	2	975-976	4
360-364	8	430-459	8	505	6	580-588	6	690	5	770-775	6	850	4	910-918	2	977-978	5
365-366	7	460-466	7	506-507	7	590-591	5	691-692	6	776-777	7	852-853	4	919-921	3	979	4
367-368	8	467-468	8	508-516	6	592	6	693	5	778-789	6	855-857	4	922-928	2	980-986	5
369-372	7	469	7	520-524	7	593-594	5	700-701	7	790-791	5	859-860	4	930-931	2	988-994	5
373-374	8	470	8	525	6	595	6	703-708	7	792	6	863	4	932-933	1	995-997	8
375	7	471-472	7	526-528	7	596-599	5	710-711	6	793-794	5	864	3	934	2	998-999	7
376-379	8	473	8	530-532	7	600-620	7	712-714	7	795-796	6	865	4	935	1		

VATICAN ASSASSINS

"WOUNDED IN THE HOUSE OF MY FRIENDS"

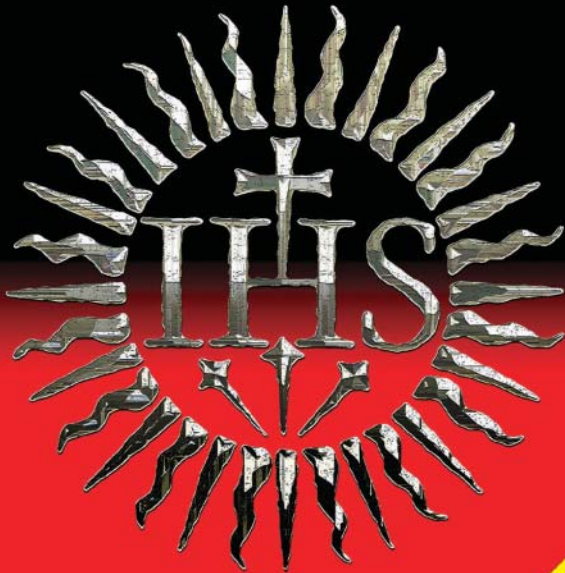

Eric Jon Phelps

CD-ROM INCLUDED!

A 700-page, 8½" X 11" embossed paperback, with over 100 rare photographs AND a Gift CD-ROM with 13 rare, out-of-print books used in the researching of *Vatican Assassins*.

SEE NEXT-TO-LAST PAGE FOR ORDERING OR CALL TOLL-FREE: 1-877-280-2866

Vatican Assassins

Wounded In The house of My friends

An explosive, detailed, shocking, historical account of the long-suppressed history of the Jesuit Order, from 1540 to the present, and their involvement behind the scenes manipulating the world through the Pope, via the Jesuit's General, the "Black" Pope—the most powerful man in the world.

If you were astonished by the front-page story in the May 2000 issue of *The SPECTRUM* titled: **The Most Powerful Man In The World? The "Black" Pope: Count Hans Kolvenbach—The Jesuit's General**, then you won't want to miss this in-depth study of perhaps the greatest ongoing conspiracy the world has ever known. Author Eric Phelps goes into countless details and fully documented facts concerning the "dark" side of the Vatican's ungodly history.

"Almost 700 pages filled with names, facts, and carefully wrought conspiracies on the kind of vast scale that creates or destroys empires."

—*The Book Reader*, America's most independent review of new titles, Fall/Winter 2001/2002

"Probably of all books which could be called 'conspiracy oriented', this is the grand-daddy. This is the Big One, I mean it...."

"It's one of those books that, even if you're a cynic and can come to terms with only half of it, it changes everything."

— Jeff Rense, Oct. 11, 2001

CD-ROM INCLUDED!

All for ONLY \$34.95 (+S/H)
Code: VAB (3.5 lb.)

THE INDIGO CHILDREN

The New Kids Have Arrived

by Lee Carroll & Jan Tober

(Featured interview in the March 2000 issue of *The SPECTRUM*.)

The "Indigo Child" is a boy or girl who displays a new and unusual set of psychological attributes revealing a pattern of behavior generally undocumented before. This pattern requires parents and teachers to change their treatment and upbringing of these kids to help them achieve balance, harmony, and avoid frustration.

In this groundbreaking book, international authors and lecturers Lee Carroll and Jan Tober answer many of the often-puzzling questions surrounding Indigo Children:

- Can we really be seeing human evolution in kids today?
- Are these kids smarter than we were at their age?
- Why do a lot of our children today seem to be "system busters"?
- Why are so many of our brightest kids being diagnosed with Attention Deficit Disorder (ADD)?
- Are there proven, working alternatives to Ritalin?

Throughout this work, Carroll and Tober bring together some very fine minds (doctors, educators, psychologists, and more) who shed light on the Indigo Child phenomenon. These children are truly special, representing a great percentage of all the kids being born today on a worldwide basis. They come in "knowing" who they are—so they must be recognized, appreciated for their exceptional qualities, and guided with love and care.

This book is a must for the parents of unusually bright and active children!

SEE NEXT-TO-LAST PAGE FOR ORDERING OR CALL TOLL-FREE: 1-877-280-2866



\$13.95 (+S/H)
Code: TIC (1.0 lb.)



2-TAPE SET
2 hrs. & 40 min.
\$39.95 (+S/H)
Code: ASV (1.0 lb.)

Anthrax, Smallpox, Vaccinations, And The Mark Of The Beast!

by Dr. Leonard Horowitz

If you are one of the millions of people concerned about recent bioterrorist threats in the wake of the Sept. 11, 2001 attacks on America, prepare yourself for a reality check. This shocking video analysis of the little known facts regarding threatened outbreaks, and the science, economics, and global politics underlying bioterrorism and forced vaccinations, features one of America's most riveting speakers. Among the world's foremost authorities on the subject of bioterrorism, vaccination risks, and public health, Dr. Horowitz's expert diagnosis here dovetails perfectly with *Bible* prophecies. Pay special attention to his disclosures regarding the infamous "Mark of the Beast". Dr. Horowitz reveals sacred *Bible* codes that give expanded meaning to the infamous "666" prophecy (*Rev: 13:18*) while implicating widely trusted vaccinations, medical biochips, politicians, and institutions that have advanced some of the most horrific population-controlling ploys ever conceived. Anthrax, smallpox, and vaccinations are all part of the same deadly swindle. Watching this video may do more than raise awareness. It may help save millions of lives!

SEE NEXT-TO-LAST PAGE FOR ORDERING OR CALL TOLL-FREE: 1-877-280-2866

5th Annual

Bay Area UFO Expo

David Icke

John Anthony West

Colin Andrews

Dr. Richard Boylan

Robert O. Dean

Stan Gordon

William Henry

Budd Hopkins

Dr. J.J. Hurtak

Barbara Lamb

Dr. Roger Leir

Jason Martell

Robert Morning Sky

Brian O'Leary, Ph.D.

Marcia Schafer

September 13/14, 2003

65 Exhibitors

UFO's - Alien Encounters

The Sphinx - Crop Circles

Area 51 - Crash Retrievals

HAARP and 9/11

Keynote Address

Robert Morning Sky

Hosts

Robert Perala and Ruben Uriarte

Santa Clara Marriott Hotel

Santa Clara, California

**Visit www.thebayareaufoexpo.com
or contact Victoria Jack at 209-836-4281**